

NOT an official Amstrad publication!



BRITAIN'S BEST SELLING MAGAZINE FOR THE  
**CPC 464 • 6128 PLUS**  
**GX4000 CONSOLE**

**ISSUE 64**  
**JANUARY**  
**1991**  
**£1.95**

# A M S T R A D

## IT'S TOO MUCH!

AA's bumper festive issue is crammed fit to bust!

- ★ **THE BEST GAME OF 1990** *Vote for YOUR favourite...*
  - ★ **SERIOUSLY NOW!** *16 pages of news, help, programming & reviews*
  - ★ **CHRIMBO COMPO** *We're giving away three hand-held TVs!*
  - ★ **SWITCHBLADE** *Gremlin's console stunner reviewed!*
  - ★ **MAGIC LAND DIZZY** *Codemasters' egg-head is back!*
  - ★ **THE AA KARTING DAY OUT** *All the gory details*
- PLUS** *All your favourite regulars PACKED in!*

More views than any other mag!

Full instructions on page 36

### AA XMAS COVERTAPE

- A** ● **PUZZNIC** *Ocean's Rave-rated puzzler – a fully-playable demo!*
- **LOST CAVES** *A full, special version of Players' brilliant budget epic*
- B** ● **SPACE FROGGY** *Complete Sprites Alive game (special offer inside)*
- **DISK OWNERS!** *A new routine to transfer all these programs to disk*

What, no cover cassette? Interrogate your newsagent now!



# ACTION



# DOWNWORLD

SCHWARZENEGGER

TOTAL  
RECALL



©1990 CAROLCO PICTURES, INC.



As  
Doug Quaid  
you have been  
haunted by recurring  
dreams of another life on Mars.

You are drawn to ReKall Incorporated, a unique travel  
service specializing in implanting fantasies into the  
minds of those who desire to turn their dreams into  
reality.

**THE EGO TRIP OF A LIFETIME**

Experience  
the horror as your dreams  
turn into hideous nightmares. Suddenly your every  
move is monitored by would-be assassins. You  
discover the surreal truth -

**YOU'RE NOT YOU - YOU'RE ME**

You  
must travel  
to Mars to discover  
your true identity - your mission  
is now a journey of non-stop action, strange mutants,  
futuristic vehicles and a startling array of weaponry all  
captured in superbly executed graphics and a game  
play that compliments the success of the  
year's top movie.



**CHASE HQ 2 Special Criminal Investigation**

continuing where CHASE HQ left off.  
The Arcade thriller takes you from the bright lights of  
Paris to the rugged terrain of the Sahara.  
Your mission is to track down,  
chase and apprehend  
the dangerous  
criminals.



TAITO

**It's FASTER**

Explosive power sends  
you bulleting through various terrains -  
hold the line or plough the fields!

**It's TOUGHER**

The criminals wield some  
heavy hardware - but so do you!  
You can shoot but you must dodge their flak...  
heavy gunfire, trucks unloading their cargo onto your  
bonnet... it's the meanest pursuit game to hit the  
micro screen.



OCEAN SOFTWARE LIMITED  
6 CENTRAL STREET  
MANCHESTER · M2 5NS  
TEL: 061 832 6633 · FAX: 061 834 0650



# SURGE

Seven levels of muscle-straining, reflex-testing, sideways scrolling fury! Destroy the lethal drug Nuke, face a stream of deadly Nuke gangs, and then - if you survive - face the terror that is

## ROBOCOP 2!

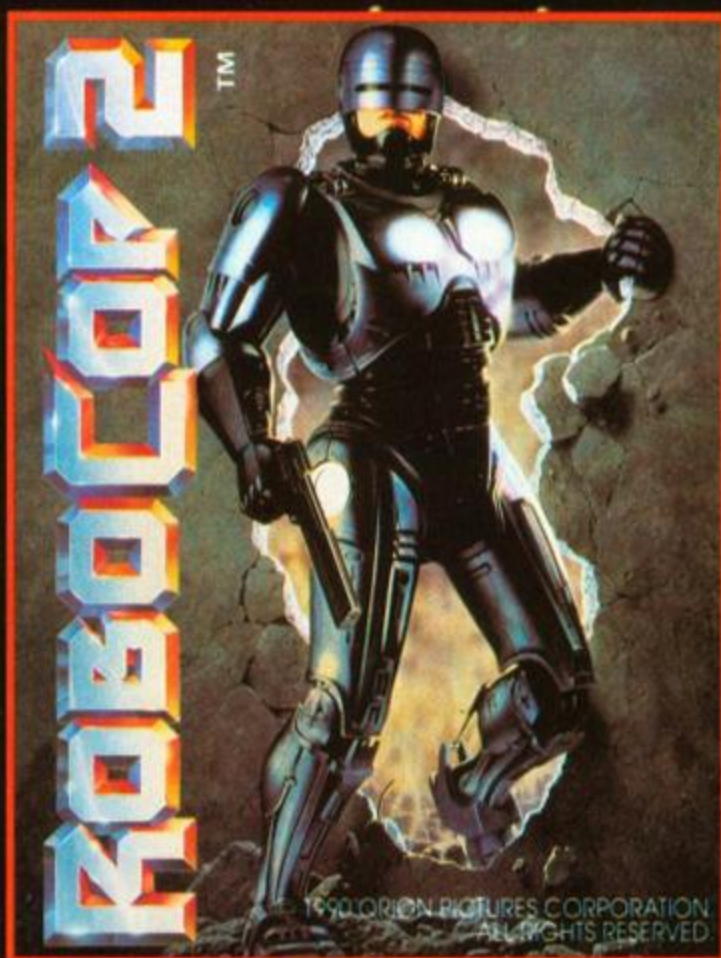

**MORE THAN A GAME - ROBOCOP 2 IS THE PRIME DIRECTIVE.**

NARC The arcade action thriller with the BIG finish. In the criminal underworld - your mission is to seek out and destroy the king pin of the MR BIG CORPORATION - if you get that far.

You'll have to outwit his enormous army of body guard gangs of charisma-bypass patients in trench coats, the brain with the build of a rhinoceros and the breath of a dung bee packs of vicious canine yuppies, the psychotic clown with an evil sense of humour - you'll die, but not laughing!

Then there's the gas guzzling cadillac jock - a cool specimen, elbow hanging on the door rail, a serious looking piece in the hand and ready to blow you away as he rolls down main street leaving you coughing lead.

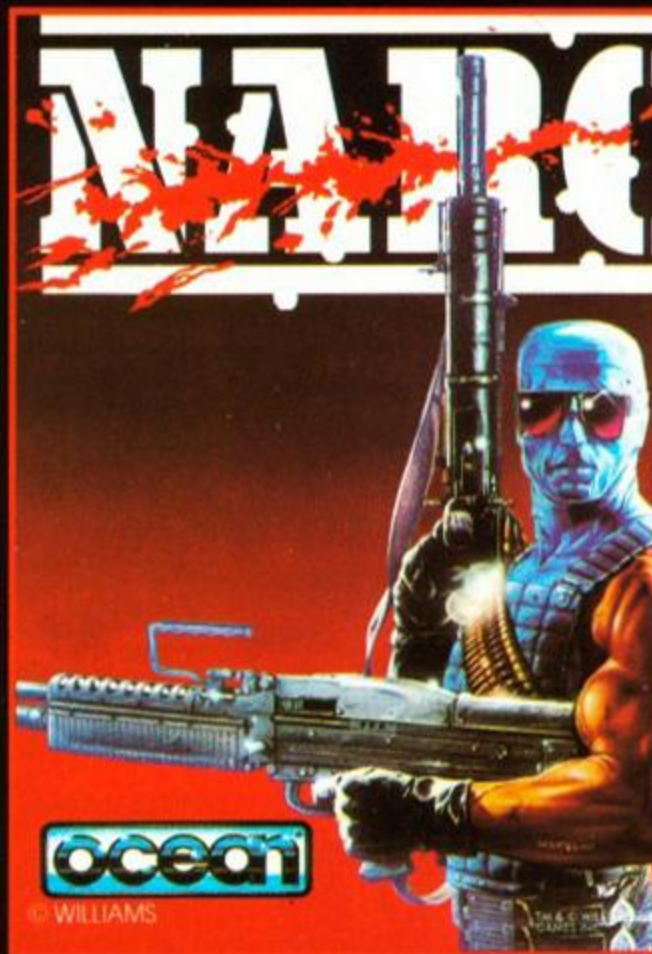

It's not all bad!... You've got a chopper to back you up, a mean, shiny street machine, some heavy metal hardware and some pretty neat moves. And what about the king pin... did I say he was Mr. Big? No, he's

## MR BIG!

AMSTRAD . COMMODORE . SPECTRUM  
ATARI ST . CBM AMIGA





MASTERS OF THE ARCADE  
CHALLENGE PRESENT...

# PLATINUM

AN AWESOME  
COLLECTION OF FOUR

## CAPCOM™

CLASSICS

GHOULS 'N' GHOSTS™  
FORGOTTEN WORLDS™  
STRIDER™  
BLACK TIGER™

Includes  
**FREE**  
L.E.D. STORM™  
8 BIT ONLY



CBM 64/128 cassette & disk, Amstrad cassette & disk, Spectrum cassette & disk.  
Atari ST & CBM Amiga (exclude LED Storm™).



© 1990 CAPCOM CO. LTD. All rights reserved. This compilation has been manufactured under license from CAPCOM CO. LTD., Japan. Forgotten Worlds™, Strider™, Ghouls 'n' Ghosts™, Black Tiger™, L.E.D. Storm™ and CAPCOM® are registered trademarks of CAPCOM CO. LTD. Manufactured and distributed under license by U.S. Gold Ltd.



U.S. Gold Ltd. Units 2/3 Holford Way, Holford, Birmingham B6 7AX. Tel: 021 625 3366.



# Regulars

- 7 **INTERVIEW** We talk to those in the know
- 8 **AMSCENE** All the latest Amstrad news
- 11 **REACTION** Our readers have their say
- 16 **ON THE GRAPEVINE** What's new on the gaming scene?
- 24 **FORUM** Adam (Doc) Waring sorts out your technical queries
- 28 **ASK ALEX** Alex van Damm brings help to beginners in distress
- 31 **CHEAT MODE BOOK OFFER** Hints, tips, maps and pokes from three years of Cheat Mode...
- 71 **THE BALROG** The month gone by in the world of adventure gaming
- 74 **TYPE-INS** Programs you can key in yourself
- 80 **SUBSCRIPTIONS** How to order your regular copy of AA
- 84 **CHEAT MODE** Another six pages of help on all the latest games
- 90 **HELPLINE** Got a problem? Need help? Send a postcard to our free contacts page
- 93 **AAFTERTHOUGHT** Tales of the month gone by, from the AA team
- 94 **SMALL ADS** Anything to sell? It costs just a fiver to reach 30,000 Amstrad fans...
- 96 **SPECIAL OFFERS** Amstrad Action bargains you just can't afford to miss

# Action Test

- 48 **FLIMBO'S QUEST** A platform game cute enough to make you sick?
  - 50 **SWITCHBLADE** Gremlin's first console game is stunning!
  - 55 **GRAND PRIX CIRCUIT** Become a Formula One champ in your own living room...
  - 63 **MAGIC LAND DIZZY** Yet another Dizzy sequel from Codemasters!
  - 66 **THE SPY WHO LOVED ME** "Bad show, James!"
  - 68 **MIDNIGHT RESISTANCE** Kill, kill, kill in Ocean's latest blockbuster
- AND MANY, MANY MORE...**

# Serious

- 39 **PROGRAMMING IN 3D** Part two of Conrad Bessant's technical tutorial
- 42 **COSTMASTER** An estimating program for small businesses reviewed

# Line up

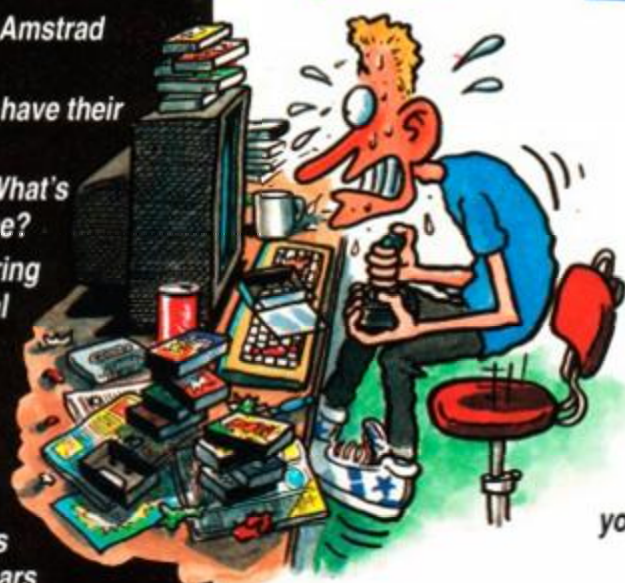

## 19 THE 50 BEST GAMES OF 1990

Part 2 of the AA end-of-year retrospective – plus your chance to vote for your favourite...

## 82 THREE HAND-HELD TVs TO BE WON

Codemasters brilliant Christmas give-away...

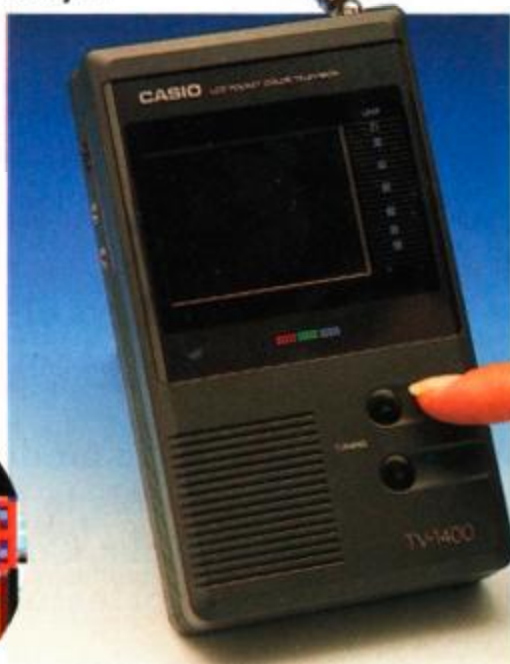

## 36 THE AA XMAS COVERTAPE

All the goodies on our bulging festive cassette plus full instructions. Feast your orbs on this, you lucky, lucky people...



## 32 KARTED OFF!

Certainly we should have been! Full report on the AA Fifth Birthday Karting Kompo winners' day out at Kastle Kombe...



## 50 SWITCHBLADE

Is this the biggest, baddest and best platform game the world has ever seen?



# ABC

Member of the  
Audit Bureau of  
Circulations

# 30,156

January-June 1990

Future Publishing Limited  
Beauford Court, 30  
Monmouth Street, Bath,  
Avon BA1 2BW

© Future Publishing Ltd 1990 Amstrad Action is an independent publication. The company producing it – Future Publishing Ltd – has no connection with Amstrad plc. We cannot guarantee to return material submitted to us, nor can we enter into personal correspondence. We take great care to ensure that what we publish is accurate, but

cannot be liable for any mistakes or misprints. No part of this publication may be reproduced in any form without our explicit written permission.

Future Publishing The company that publishes ST Format, Amiga Format, Your Sinclair, Commodore Format, Sega Power, New Computer Express, 8000 Plus, PC Plus, Mac Publishing and Classic CD.

Tel: 0225 442244 ● Fax: 0225 446019 ● Editor Rod (Rasputin) Lawton ● Reviews Editor Adam (Brains) Waring ● Staff Writer James (Bruiser) Leach ● Contributors Alex van Damm, Conrad Bessant, Stuart Whyte, Phil Howard, Caroline Lamb ● Art Editor Ollie (Nay, nay and thrice nay!) Alderton ● Additional design Paul (Smiler) Tudor ● Advertisement Manager Simon Moss, tel: 0225 442244 ● Publisher Greg Ingham ● Assistant Publisher Jane Richardson ● Publishing Assistant Michele Harris ● Production Melissa Parkinson ● Subscriptions Christine Stacey, tel: 0458 74011 ● Mail Order Claire Bates, tel: 0458 74011 ● Circulation Director Sue Hartley, tel: 0225 442244

Sorry and all that, but we're so busy putting your favourite Amstrad mag together that we don't have time to take all those readers' calls about cheats, listings, best buys and so on. That doesn't mean we can't help you out, though – course not! Just send a letter to Cheat Mode, Forum, Reaction, Ask Alex etc and we'll do our darndest to sort you out!



# KICK OFF 2



## Blistering Pace - Pixel Perfect Passing - Superb Tactical Game Play

- ★ 1 to 4 players option (Amiga & ST)
- ★ Kit Design (Amiga, Atari ST & IBM)
- ★ Facility to load Player Manager teams and designed tactics.
- ★ Instinctive joystick controls to pass, dribble, shoot, head or chip a ball and do sliding tackles.
- ★ Two players teams mode against the computer.
- ★ After touch controls to bend or dip the ball.
- ★ Set piece Free Kicks, Corner Kicks, Throw Ins, Injury Time, Action Replay, red & yellow cards indeed host of features to create the atmosphere of a soccer game which is real fun to play.
- ★ League and Cup Competition with sudden deaths penalty shoot out.

- THE ONE** - *Ultimate soccer simulation.* 96%.
- THE ACE** - *Brilliant. Buy, Boy, Buy.* 93%.
- AMIGA FORMAT** - *Best footy game to have appeared on any machine.* 94%.
- ST FORMAT** - *What a game! Gem to play. Magic.* 90%.
- C & VG** - *Championship winning material.* 95%.
- GAMES MACHINE** - *Probably the best sports game ever.* 92%.
- COMMODORE USER** - *No other footie game can touch it.* 90%.
- AMIGA ACTION** - *Surpasses all other football games.* 93%.
- POPULAR COMPUTING WEEKLY** - *Nothing short of brilliant.*
- NEW COMPUTER EXPRESS** - *Computer football event of the year.*

AMIGA & ATARI ST .....	£19.99
IBM .....	T.B.A.
CBM 64, SPECTRUM & AMSTRAD .....	£9.99 Cas.
CBM 64, SPECTRUM & AMSTRAD .....	£14.99 Disc
KICK OFF 2 & WORLD CUP (AMIGA & ATARI ST) ..	£24.99
KICK OFF 2 (Expanded Amiga) .....	£24.99







Amstrad Action was so impressed with Prisma Software's 'multimedia' approach in *Learn to Read with Prof* that we wanted to know more. ROD LAWTON spoke to Senior Partner Trude Salisbury about the company, the software, and education in general.



● Trude Salisbury works part-time as a voluntary teacher.

We were impressed by the way that you combined books and audio cassettes and a computer game. What's other people's reaction been to this? Because it's something quite new as far as we're concerned for computer software.

Well, the education establishments are very pleased with it. We've been selling to them for some years now on another format, and the parents are delighted with it. They've found the children learn to read very quickly and

**"...it is quite unique that our program actually teaches reading. I don't really think there is anything on the market to compete."**

then of course to prove that they have the books and then, having proved that to themselves, they can then go and read other books.

So did you produce the same sort of thing on the BBC, then?

Oh yes. We've been selling the BBC version to schools since 1985.

So have you modified the software at all for the home market?

Well we've improved it, shall we say. We've put more graphics in. It's been just as successful without a lot of graphics, but now, since we've gone into the home market we have put more graphics in and also added nine more words.

So the software is designed now in such a way that it can be used at home as well as at school.

That's right. That's what we're doing now -

# Learn to read with Prisma...

we're selling to the home and schools with the new version.

What do you think of the CPC as an educational machine? Obviously, it's not as popular in schools as the BBC - what do you think of its capabilities?

It can do what we want it to do, you see. As far as I'm concerned, it doesn't really matter, the machine. The game is the same on all the machines. So if that is the machine that is in the home it will do the job.

You've obviously looked at various other people's software as well. Without necessarily being specific, where do you think other publishers' educational software falls down?

Well, it's not for me to say, is it? I would just say that we are more specific, you see, and we have found that our software really does teach reading. So you can take a non-reader, or any age, really - we've sold to high schools - if there was a need. While we would expect in the home market to mainly sell to families with children of four or five years of age. We also sell to parents of older children if the children can't read. And it is quite unique that our program actually teaches reading. I don't really think there is anything on the market to compete.

Do you think it's unique in that it combines written material with audio cassettes and computer software?

It's got to, you see, because you can't teach words without putting them into context, and then when you've learnt the words, well you want to *know* what you've learnt - even four-year-olds want to *know*, you see. So the books then prove to the child that also they can practice what they've done. And then they have the confidence for another book.

Obviously you think computers are a valuable learning tool. Do you think they'll be a central part of education from now on?

Oh yes, I don't think you can get away from that. It's just how you use them, isn't it? Quite often, you see, they're used in schools with the brighter child, or the child that has already got some knowledge of reading and other things, and the children who can't read can't use them quite as much.

With the increasing use of computers in schools, do you think it's most important that kids get used to using them, or do you think that they do actually add an extra dimension to teaching?

Well, if they're used right, you see, they're just

an essential part now, and it will get more and more so, won't it? And they're a part of the home as well - more and more families get computers. And if you can use the computer as a teaching tool to support what the teacher is doing, whether you actually use it in the school and support what the teacher is doing, or whether you use it at home and support what the teacher is doing, it can only be a good thing.

**"...if you can use the computer as a teaching tool to support what the teacher is doing... it can only be a good thing"**

Are you planning further releases?

You've got Part 2 of Level 1, haven't you?

Yes.

That then takes the same words and looks at them in more detail. And then early in the New Year we will have Part 3 and 4. Part 3 helps children to make sentences - this is something children don't find very easy. And Part 4, then, deals with comprehension, to ensure that children really understand their reading - but all in a fun way. So they don't know that you're encouraging them to write sentences or teaching them comprehension. And that is Level 1. Now all these four parts can be used on their own - you don't have to start with Part 1. But each one has a different thing to do. And then we go on to Level 2, which is really the same thing, but teaching more words, you see.

Its sounds like there's quite a lot in the pipeline, then?

We've found that there was a need for the other parts. I go into a school on a voluntary basis, you see, and work with children, and through that I have found the need for the other parts. And since then we have had letters from parents and teachers to confirm that.

Are you likely to branch out in future, or are you going to see how the *Learning with Prof* series goes?

We're already branching out, you know! You can't stand still, can you? There are other things in the pipeline as well, which I am sure you will get next year.

Right, so we'll have to wait and see, then...? Yes!



# Amscene

releases... updates... previews... new releases... updates... previews...

## BUT WILL IT WORK?

### Unexpected compatibility problems emerge with new 6128 Plus machines

Compatibility problems concerning Amstrad's new Plus range seem worse than originally feared. It's emerging that a number of products designed for use with the CPC will not work with the new computers.

The new machines are designed to emulate the old CPCs exactly – until a cartridge is plugged in, whereupon the new console hardware is activated. It seems that some existing software nevertheless does clash with the hardware.

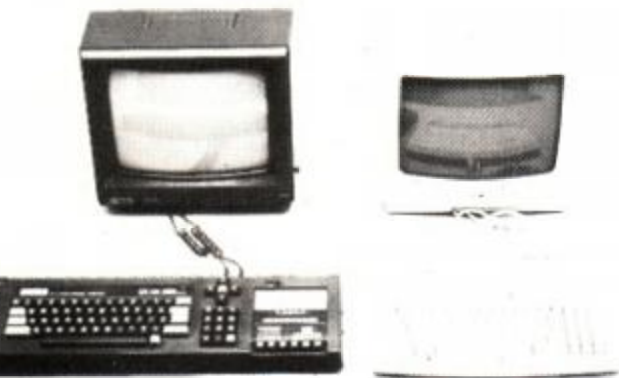

● CPC6128 and 6128 Plus: how compatible are they?

At first it was thought that the amount of software that wouldn't work with the machine would be very low – but increasing numbers of programs are proving troublesome when loaded on the new machines. Both games and serious programs have been affected.

The incompatibility of these programs is currently being attributed to programmers not 'following the rules' set out by Amstrad, rather

than any technical problem with the computers.

Among those games affected are three Loricels products – *Harricana*, *Bumpy* and *Mobileman*. These fail to run on Amstrad Action's new 6128 Plus but work perfectly on the office CPCs.

We canvassed the opinion of leading software house US Gold and were told that efforts are being made to ensure that all new games work on all machines. It's unlikely that previously released games that have been found to be at fault with the software will be altered to work with the new computers, though recent games still doing well may be converted.

This action will almost certainly be taken by all major software producers, meaning that once the new machines are established, all new releases should work without problems. It does mean, however, that older games that don't work on the Plus will not be upgraded.

A similar problem occurred with Atari's 16-bit ST machine, when the company upgraded it to the STE. However, the Amstrad compatibility problem would appear to be far less serious.

#### Multiface frozen

The Multiface II game 'freezing' device has also been found to be incompatible with the 464 and 6128 Plus machines. The unit appears to operate normally until the 'save' function is accessed, upon which the computer locks up, requiring the machine to be reset.

It appears that Amstrad had tested the



● Multiface II hits problems with Plus machines.

Multiface for compatibility with the Plus on manufacturer Romantic Robot's behalf, and gave the company the green light. Romantic Robot then started to produce the unit with the new 'D' type connector that the Plus uses. The problems only became apparent when customers complained that the device did not work properly.

Romantic Robot is currently redesigning the product to work with the Plus. According to the company, the problem is a fairly minor one. It's caused by incompatible software which needs to be rewritten, rather than a hardware clash. The modifications should be complete by the time you read this.

● Anybody having trouble with a Multiface that they've already bought should get in contact with Romantic Robot, who have promised to exchange all faulty units with correctly functioning ones.

Romantic Robot can be reached at 5 Deanscroft Avenue, London NW9 8EN, tel: 08 200 8870.

### BMW JOYSTICKS!

Joystick maker Spectravideo is no longer going to be selling Konix joysticks. Another supplier for the highly-rated Speedking and Navigator models has yet to be found.

In the meantime, Spectravideo is to launch a new range of its own, collectively titled the Logic 3 range.

"Logic 3 products will be designed with three main criteria: style, engineering quality and reliability. Our products will be the BMW of the joystick market." So says Spectravideo boss Ashvin Patel, who may or may not own one of those Bavarian beasts himself. (No-one wants a joystick like a Ford Escort...)

Details are all very hush-hush at the moment, and no piccies or prices are available yet. Watch this space...!

### Keep it under control

Fed up fumbling with joysticks? Can't take control with the keyboard? A new widget to allow custom control for your games playing has just become available.

The Game Pro Mk2 plugs into the joystick socket of your computer. It has a couple of built-in buttons duplicating the up and down movements of a joystick, and a load of input sockets to plug further controllers in. These use standard jack plugs, so the home experimenter can construct all manner of weird and wonderful game playing devices.

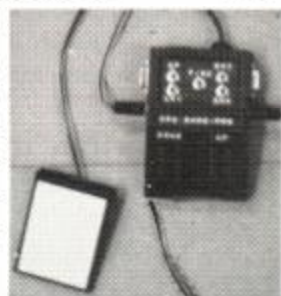

In addition, there are two joystick ports built in, acting as a joystick splitter for the CPC. Now you'll be able to play two-player games the way they should be played; with two joysticks.

The unit also comes (there's more?) with two foot-pedals. Prices range from £19.99 to £34.99.

CpRs Design Technology is responsible for the product. The company can be found at 70 Potton Road, Eynesbury, Hardwicke, St Neots, Cambs PE19 2NN. Tel 0480 76038 (evenings only).





# 6128 Plus will load from tape!

Up until now, one of the fiercest criticisms of Amstrad's new 6128 Plus is that it will not load from tape. Its predecessor, the CPC 6128, loaded tape software easily via its built-in tape socket, but the Plus model has been restricted to disk-only operation.

Until now! WAVE, up in Cumbria, is offering a special service to 6128 Plus owners whereby their machines can be converted to load from tape. **The machines will still not be able to save to tape** – but few people would want to do that anyway. The principal need for the tape loading feature is for budget software, after all.

The cost of the conversion work is £20, with an extra charge for carriage. Alternatively, if you buy your machine from WAVE in the first place, the company will convert it for you *free*, as well as offering a £25 discount off the RRP.

For the latest details, write to WAVE at 1 Buccleuch Street, Barrow-in-Furness, Cumbria LA14 1SR, or call 0229 870000.

● N.B. If you do have your machine converted by WAVE or anyone else, the manufacturer's warranty will be invalidated – you have been warned!

## THE DRIVE SAGA CONTINUES!

Microstyle has embarked on the DD-1 drive price-cutting war again with a remarkable offer on these Amstrad drives. For as little as £69.99 (plus £3 carriage) you can equip yourself with an external 3-inch drive for your 464, complete with necessary interface.

Microstyle is stressing that the offer can last only until the stocks are exhausted, so if you want to take advantage of this monster offer, get in there quick!

Regular readers will know that following Amstrad's decision to cease manufacturing these drives, there has been a price-cutting bonanza on these items. Stocks have gradually fallen, however, and the overall price trend has been upwards. Until now...

Microstyle's address is 212 Dudley Hill Road, Bradford, W. Yorks BD2 3DF, or you can call 0274 636652 (after 2pm).

## PICK UP A PENGUIN

Last month's *Free for all* section carried an incorrect phone number. Penguin Software's correct number is 0483 763223, and not as printed. By the way, if you've tried getting hold of boss Dave Carter via the directory, it *doesn't work*, and you'll have been making a totally unrelated Mrs Carter very annoyed.

Sorry folks, and especially Mrs Carter!

## But no, seriously

How about this for an excellent idea – a 'bundle' for the new 6128 Plus which included serious business or word processing software on a cartridge? We reckoned that the cartridge format would be very suitable medium for all sorts of serious utilities. Integrated packages that allow you to switch between applications instantly, for example. Or word processors with huge built-in dictionaries.

This would, we thought, solve two problems. Amstrad could affirm the Plus range as being general-purpose rather than just games machines, and if the software was to be given away with every machine, a serious producer would jump at the chance. We put the idea to Amstrad...

Unfortunately, Amstrad said that it had no plans for any such programs, though it would welcome the idea if a serious software manufacturer were to approach them. The company also dismissed outright the idea of a 'serious bundle', say-

ing that the new models are being pushed purely as games-playing machines. "It would just confuse the market" Amstrad observed, when asked why a serious bundle wasn't on the cards. Amstrad already produces bundles with its PC machines, and clearly wishes to separate the functions of the two ranges.

● Arnor, the makers of word processor *Protext*, told us that it wasn't considering cartridge releases, but wouldn't rule them out as a future possibility.

**We want to know what you think. Should the new machines be restricted to games only? Or should there be serious applications for a machine that is perfectly capable of making use of them? If there is enough interest we'll take it up with the companies involved.**

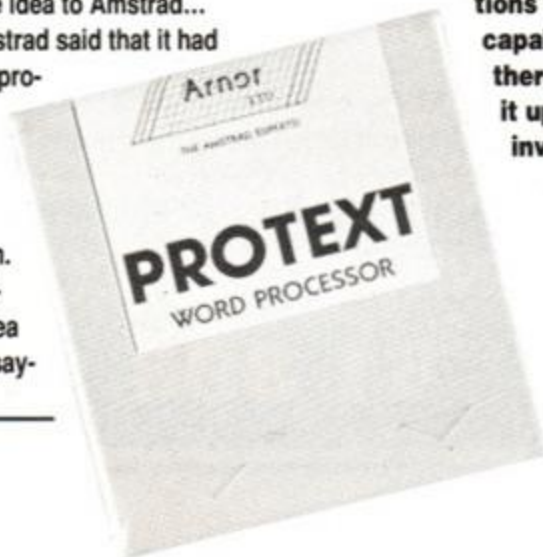

● Will we see the brilliant *Protext* on cartridge? At the moment it seems not...

## THE CHARTS

Well, *Shadow Warriors* is still there at No. 1. You lot out there obviously like it, even though we only thought it worth a measly 68% back in AA68!

As for *Batman – The Movie* and *Robocop* – can you believe they're still going! It's nice to see some of the smaller software houses like Chrysalis, Challenge and Addictive getting in the charts too.

## FULL-PRICE GAMES

(Software priced over £4.99)

1	1	Shadow Warriors	Ocean
2	5	Turrican	Rainbow Arts
3	4	World Cup Soccer '90	Virgin
4	3	Chase HQ	Ocean
5	6	Robocop	Ocean
6	14	Batman – The Movie	Ocean
7	8	Manchester United	Chrysalis
8	16	Foot. Man. World Cup	Addictive
9	12	Heroes of the Lance	US Gold
10	2	Back to the Future II	Mirrorsoft
11	20	Italy 1990 Winners	US Gold
12	15	Gazza's Super Soccer	Empire
13	7	Bomber	Activision
14	19	World Cup '90 Comp	Empire
15	NE	Cricket Master	Challenge
16	11	Heroes	Domark
17	NE	Lords of Chaos	Blade
18	NE	Int. 3D Tennis	Palace
19	NE	Turbo Out Run	US Gold
20	10	Dragons of Flame	US Gold

## BUDGET GAMES

(Software priced under £4.99)

1	1	Quattro Adventure	Codemasters
2	8	A Question of Sport	Encore
3	NE	Pro Boxing	Codemasters
4	5	Rastan	Hit Squad
5	7	Paperboy	Encore
6	NE	Big Trouble/Lit. China	Alternative
7	NE	Temple of Doom	Kixx
8	NE	Daley Thomp. Chall.	Hit Squad
9	NE	Hong Kong Phooey	Hitec
10	NE	Salamander	Hit Squad

This chart is compiled by Gallup Ltd.

© European Software Publishers Association Ltd. 1990



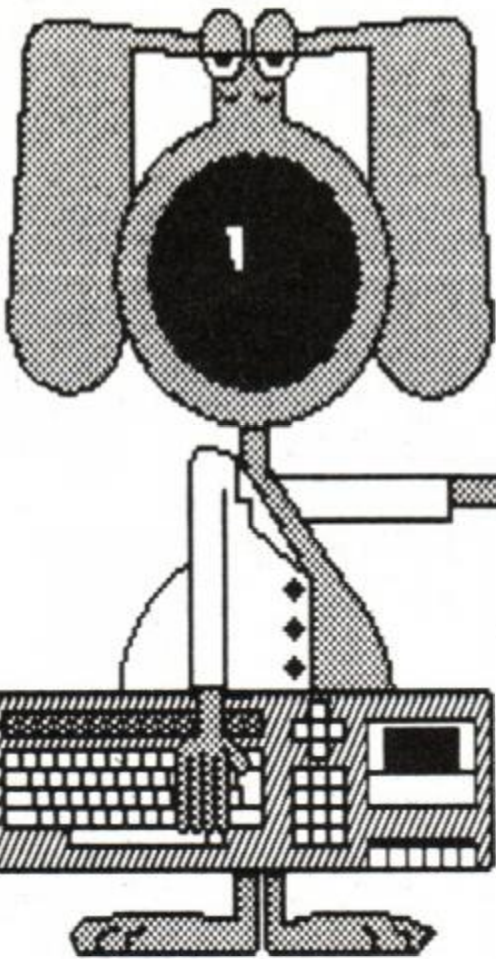

# WACCI

unbeatable value, unbeatable service

## THE MAGAZINE

### ANNUAL SUBSCRIPTION RATES

UK.....	£18.00
Europe.....	£27.00
Overseas.....	£36.00
Introductory Issue.....	£1.50

- \* Fully illustrated
- \* Over 20,000 words per month
- \* Proper A4 format

Letters, Basic, Comms, Mcode, Hardware projects and much more.

A truly  
Alternative  
Fanzine

### MULTI FILE UTILITY (MFU)

The CP/M+ program that lets your CPC analyse and format any of the 'large' discs formats (IBM, BBC, Osborne and many many more) and copy files to and from these formats.

"Head and shoulders above the competition"

AA July 90

"MFU is the fastest of all" Computer Express

Issue 88

ONLY AVAILABLE from WACCI.....£29.95

### THE LOWEST PRICES ANYWHERE!

CASPELL RIBBON REFRESHER.....	£7.95
Rombo Rom Box NOW ONLY.....	£27.00
VIDI-CPC digitiser NOW ONLY.....	£59.95
5 x Amsoft quality discs.....	£11.95
10 x Amsoft quality discs.....	£22.95
20 x CF2 discs.....	£44.95
DMP 2000/3000 Printer Ribbons (each).....	£2.90

### THE PUBLIC DOMAIN SOFTWARE

#### CPM DISC 1 - MACHINE CODE TOOLS Price £6.50

Z80 and 8080 assemblers, Z80 to 8080 to Z80 code translator, Debugging monitor and assembler, Reverse assembler, Binary file comparer, plus NewSweep and more.

#### CPM DISC 2 - COMPUTER LANGUAGES Price £6.50

Small-C, Prolog, Lisp, EBasic, Small-C-Interpreter plus NewSweep.

#### CPM DISC 3 - FILE AND DISC MANAGEMENT Price £6.50

Library utilities, Disc quality checker, Unix GREP command, PCW disc reader, Disc sector editor, Text file sorter, Word counter, plus NewSweep and more.

#### CPM DISC 4 - AT YOUR LEISURE Price £6.50

Cave Adventure, Chess, Othello, Golf, Word search, Biorhythms, Maze generator, On-screen calculator, Prolog, Comms utility, plus NewSweep and more.

#### CPM DISC 5 - THE BUSINESS Price £6.50

Scrivener spreadsheet, Inventory database, Powerful text editor, Spelling checker with dictionary, Sorter, Word counter, Comms utility, plus NewSweep and more.

#### CPM DISC 6 and 7 - PASCAL PLUS (Two Discs) Price £10.00

Pascal, SCI, Cobol, EBasic, Powerful text editor, plus NewSweep.

#### CPM DISC 8 - MORE COMPUTER LANGUAGES Price £6.50

Forth, Stoic, Cobol, Expert 86, Powerful text editor, plus NewSweep

#### CPM DISC 9 - COMMUNICATIONS Price £6.50

Mex, Kermit, Kermode, Interface and Smart-Modem, overlays, source code, plus NewSweep and more.

#### CPM DISC 10 - MORE BUSINESS Price £6.50

VDE 266, Andybase, Newsweep, Filer Sideways, New CCP, Print, Edit

### THE SPECIAL OFFERS

MasterCalc 128.....	£24.95
MasterFile III.....	£29.95
MasterCalc AND MasterFile.....	£49.95

Protext (CP/M+).....	£47.00
Pocket Protext (CP/M+).....	£23.25
Protext Office.....	£27.25
Protext Filer.....	£19.50
Maxam 2 (CP/M+).....	£39.00
BCPL (CP/M+).....	£19.50
Arnor C (CP/M+).....	£39.00

### PLUS ★ PLUS ★ PLUS ★ PLUS ★ PLUS

Public Domain software support available to WACCI subscribers.

Mega-big homegrown library

Send £1.50 for full catalogue and details (E and OE).

WACCI UK, 9 SOUTH CLOSE, TWICKENHAM, MIDDX TW2 5JE

Est. 1986 — Phone 081 898 1090



# Reaction

Controversy, contradiction and calumny! Our readers grind their axes...

## ● Free for all frolics

I'm a 24 year-old electronic engineer and have had my trusty 464 for six years. I think your mag is excellent and you seem to have the right balance between serious and "fun" software.

I particularly enjoy *Free for All* and would be very grateful if you could tell me where to go for the PCB-Draught program reviewed in Issue 62. I don't have a modem so I hope it's not from a bulletin board...

I only have one piece of criticism and that is you should update the "Where to go" box in *Free for All*. For a number of months now the DW Software entry mentions the "marvellous WIMP environment desktop reviewed last month". There must be a few very confused readers out there (*they're not the only ones - ed*).

One more thing - what is a clam? Is this the new form of European currency?

Keep up the good work.

Andy Mans  
Newbury

P.S. If by amazing coincidence you print this letter, please please spell my surname properly!

AA: Oh. All right. It's Andy Properly of Newbury.

PCB-Draught, eh? Caroline wasn't in when we phoned so we're not sure if it's PD. If it is, it should be knocking around a few of the libraries. Try WACCI - the address is in the Where to go box.

Well done for spotting the deliberate mistake we made by leaving that out-of-date item in *Free for All*. Award yourself 10 points.

A clam is a salt-water crustaceous gas-

## ● (Christmas) stocking the cartridges

I am thinking of buying a GX4000 console. Would you please let me know what games will be available for it by Christmas?

Ben Spires  
Stroud

AA: How about... *Gazza*, *Dick Tracy* and *Spiderman* from *Entertainment International*? And then there's *Navy Seals* and *RoboCop 2* from *Ocean*, *Epyx Games*, *Tennis Cup* from *Loricels*, *Tin-tin on the Moon* from *Infogrames*, *Klax* from *Domark* and many more. All these should, with any luck, be in the shops before Santa performs his annual soot-covered descents.

## ● Down with tapes

I must be one of the few people around who supports the lack of a cassette port on the new 6128 Plus computer.

Let me explain. Once upon a time the IBM PC (what's that? -ed.) had a cassette port. Now it does not. Every user of the PC uses disks, and quite happily I might add. The way to get the whole CPC user base onto the more practical storage medium of discs is to 'force the change', and I support Amstrad if this is their intention.

Can anybody really prefer cassettes? They may be slightly cheaper to buy, but this is probably due to the larger production runs for cassettes than for disks. If a larger customer base is forced to use disk, then the price difference will close, meaning that the advantages of disk will cost little or no more than cassette.

How many 464 owners buy their machine on the basis of immediately adding a disk drive and using disk as their primary storage medium? They may still buy software on cassette, but if they then copy their cassette to disk (possibly with the Multiface) and use the cassette no more, then they do NOT support cassettes. The fact that they buy a 464 and

tape software does not infer otherwise.

my view is that if you want the advantages of disk, then go the whole hog. I support disk options for all CPC software including AA cover cassettes, and the freebie cassette games given with AA subscriptions. What's AA going to do about these? They are useless to 6128 Plus owners.

John Fairlie  
Bristol

AA: If Amstrad was to phase out cassettes, would it begin by creating a computer that couldn't support them?

The 6128 Plus will certainly have that effect. And as long as it doesn't happen too quickly, leaving people high and dry, isn't the gradual reduction of the amount of cassette-based systems a good thing? Disks are, after all, much more convenient, more reliable, faster, and in all respects apart from price, better. It must be about time that a distinct move was made in favour of a disk-only market.

Or is it? What do YOU think? Disk? Tape? Both? Write to *Reaction* and get YOUR views known.

tropic bivalve, frequently encountered in estuarine and marine environments as well as certain fishmongers. We also use them as a form of easy-to-handle currency. 1 clam equals 1 pound (or a squid).

## ● Favourite cover versions

To start off, I would like to say how brilliant your mag is, and how I think it can never get better, but it always does. OK, I have finished my grovelling; now to get on with my letter.

I typed out *Hacker*, in issue 43. It seemed to work well, but what do I actually do when I get given "POKE &023E,0"? I have discarded the last two numbers as it told me to.

I read a letter in a past issue asking why it would cost £2.95 if you had a cover cassette. How come then, on your birthday issue you had a cover cassette (and a very good one too) but the issue cost only £1.95?

I think the cover of issue 62 is the best one yet. I do not know why, but it just is. Please please answer this letter.

I also want to know what AA's favourite game is. At a guess, I would say *Rick Dangerous*. And is *RoboCop* the Amstrad game that has stayed in the charts for the longest? You had better answer this letter or I will set him on you!

AA: *RoboCop's Directive Number Seven* is as follows: "No member of Amstrad Action or Future Publishing may be harmed". It's a little



● There should be many excellent games for the GX4000 by Christmas.





known (and totally made-up) fact that Adam 'Doc' Waring actually programmed the RoboCop software, and his silicon heart is that of a now-defunct CPC 664.

As for cover cassettes. It would cost much more for a cassette every month, but when we mount them (i.e. twice a year), we actually pay much of the increased cost ourselves. Such is our generosity.

Which cover IS the best? We often argue about this, and several scuffles have ensued.

● Cartridges for all and sundry?

I was reading Amstrad Action (Issue 62 page 21) when I saw an advert for the new Plus machines. It said that you could plug in console ROM cartridges. My question is can I upgrade my 6128 to load cartridges like the Plus? And if it is possible, would you tell me what the extension is called, and the retail price of it?

David Taylor  
Warrington

AA: It is astronomically unlikely that such a device will ever exist. It certainly doesn't at the moment. If, in the dim and far off future it does, we'll let you know all about it (and you'll also witness the advent of porcine aviation over Warrington).

● Fair play for astronomers?

I have always believed that we computer buffs are a decent bunch of people ready and willing to share information with others, as I have done so on numerous occasions. Unfortunately, there are those amongst us who are not able to play the game.

In Amstrad Action Issue 60, Sept 1990 you published my letter seeking a copy of Amsoft's Star Watcher program to which I did not receive any direct reply.

However in your Issue 62, Nov 1990 you published a letter offering me a copy of this tape if I would ring the telephone number given. Upon doing so I was surprised to learn that it had been sold to a person in Scotland who had seen the letter with the telephone number, without giving me the opportunity to purchase it.

I realise that nothing illegal has been done but if this had been me I could not have behaved in such a reprehensible manner to a fellow computer user.

I wonder, therefore, if you would be kind enough to publish my full address and telephone number so that anyone who has a copy of this tape can contact me direct.

David Webber  
Cummal Fayle  
28 Ballaterson Fields  
Ballalough  
Isle Of Man

Tel: 0624 897462

AA: If anybody has a copy of Star Watcher by Amsoft, could they get in touch with David at the above address. Go on - restore his faith in human nature.

● Sexism - the debate continues



I am afraid it is time once again for me to impose my views upon you. After reading the letter from a certain Catherine Dawson I nearly hit the roof. For a start she was accusing your mag of being sexist, when you have never portrayed such opinions, She then goes on to say 'you can't say... women are hopeless at computer-related subjects' - who said they were??? Is this woman paranoid or what?! OK, so you learned BASIC at eight etc... good for you. Just don't hit me with this feminist crap, OK? It's a computer mag, not Women's Lib.

All that aside, I thought she had some kind of sense saying that there shouldn't be sexism, but she went on to show that she was actually no better or less prejudiced than sexist men by saying that women were the superior sex at anything they tried. Not so bloody unbiased now, are you??

Given your 'opinions', am I right in thinking that the school you pass your mag around at is primary school, or kindergarten maybe?

Right, now where was I? Oh yes, someone wrote in saying that the Home Computer Club was a rip-off. Well, OK. In this example it was you who was at fault, but they do rip you off. For example if a compilation is brought out; let's take the Cecco collection; well it comes out at £10-£20, but they say that the games come as four individual ones and charge you with the reasonable price of £40 minus the 25%. Total rip-off or what?

I am glad to see you have ditched the Buyers Guide. Total waste of space. It was the

same every month. I do hope you don't mind me asking, but did the Publishers make you do the cover tape on AA617

It's just that Your Sinclair have the same tape, more or less, on their cover. They also did the free 'Cheat Mode' booklet. It's just that since Future Publishing bought YS, everything you do, YS

also does. So do you come up with the ideas or does Future Publishing?

May I say that I was less than happy about paying an extra 50p for a tape with a demo and a game on it. In fact, I am sending some progs in to Type-Ins, and to show you what I think of the tape, I am sending the progs on it!!!

I have said it before, and I'll say it again, don't put cover tapes on every month. Because if you do, you will rely on the tape selling the mag, not the contents, so you will start getting slack with the mag.

And I want a magazine, not a game demo.  
Adrian Forbes  
Gourock

AA: Come on, Catherine Dawson. Isn't it about time you wrote in again? We'd love to have another letter from you, and you must want to reply...

And about the Home Computer Club; they don't price the games in a collection separately; they take the Recommended Retail Price of the collection in the shops, and lower that by the stated amount. It's possible they were merely stating the price that the games would have cost if they were sold separately.

Covertapes. You might not want the programs on them, but many readers enjoy their occasional appearance (or so we fondly believe).

● Has AA forsaken us?

I saw the new logo. Why change? It looks terribly dated and crass - as if it had come off the cover of a games-only Speccy mag. Why are games getting more and more coverage?

Next quibble: "Britain's Best... CPC 464 . 6128 Plus . GX4000 Console. Surely this leaves out original users? How about 464 . 664 . 6128 . 464 Plus . 6128 Plus . GX 4000 Console"?

Why has serious software got so small? I think that's about all I've got to moan about. I hope my opinions are listened to - wouldn't it be a shame to lose a reader who has all 62 issues?

Mark Baxter  
Stockport

AA: The logo was really up for a redesign. We like it a lot. But everybody has their own opinion, and we only find out what you think if you tell us. And as for original users. We've stated repeatedly that we will continue to cater for all existing users. we do mirror the changes in the CPC owning public. For example games sales are increasing rapidly, consoles are selling and cartridges are being produced at a prolific rate.

It would spoil the balanced look of the cover if we had a massive box paying homage to every Amstrad CPC machine available. You just have to open and read AA to realise the extent of our coverage.





● **Veni vidi MIDI**

I am writing to your esteemed publication in desperation. The problem is that I am interested in buying a MIDI synthesizer and due to the fact that I am totally ignorant of any aspect of music I have in desperation set these questions;

- What synthesizer would you recommend in the £250 region (i.e. a low budget)?
- Where could I acquire an interface and how much would it cost?
- What software would you recommend that would fully utilise the synths' power (for a low budget)?

● **What's the best synth on a low budget?**

I would be very grateful if you would answer these questions, and I'm sure that many would benefit from the answers.

**Kieran Bury  
Co. Sligo, Eire**

*AA: There are many good keyboards available for under £250. Examples are the Casio CT470 costing £229 or the Yamaha PS 790 for £230. The Yamaha includes 100 sampled sounds, a*

five octave keyboard, 50 sampled drums and stereo sound.

However, your local music shop should be able to offer much more detailed advice.

In the MIDI interface department, Dattel Electronics makes the Music Machine. For under £50, this offers a wealth of features for the MIDI musician. It's also a sampler and a drum machine. It comes with its own software, so you don't need to worry about that aspect.

● **Colour in a drab world**

Earlier this year, after studying the many types of dot matrix printers, I decided that the Star

● **Money-clip art?**

I feel I must write to you concerning your review in the November 1990 edition of Amstrad Action, of the recent addition to Goldmark's software range, Graphics Galore.

I recently purchased six of the clip art collections after seeing an advert in another CPC magazine. I first obtained the catalogue to see what was available and to see if it would suit my needs at this present time. This I received by virtual turn round of post, despite sending a cheque and assuming a wait of between 10 and 21 days for the cheque to clear.

I then ordered the six sets that suited my particular purpose, and again was extremely surprised at the turn round from the company. The total cost for these six sets was £62, and not, as you infer, £72. The fact being that if one requires more than one set, up to a maximum of twelve, these can all be fitted onto one disk. Only the first set costs £12; any additional sets on the same disk are then sold at £10 each.

As to the fact that some of the pictures are the same, this being just the thing I need, as at the time I am producing small newsletters for two local churches, among other projects, and the different styles are extremely useful to differentiate between the two.

As to the overall cost of this suite of programs, £378 if all the sets were purchased as above, on four disks, and not £444. As I only have a CPC 6128 and 464, I would not like to have to purchase a PC, ST and Mac to enable me to have these facilities at my disposal. As you quite correctly stated in your review, someone else has gone to the time and expense of converting these to allow we CPC users to have facilities that were previously only available on several different systems. How much, for example, would Printmaster for the Apple Mac cost? As I understand that this has 122 pictures as its basic range.

Working as I do for a local printing firm and using computers myself, and having just started to convert ASCII files alone from one

format to another, I can understand the time and effort spent by Brian of Goldmark Systems on getting this program ready for us lesser mortals to use. This includes writing the program for actually allowing the individual pictures to be merged into our individual DTP programs.

As a follow up to using this program, I wished to try something else with it and upon phoning Brian one evening at about 9pm with my query, he then went through the method of doing what I wanted over the phone, while I did the keying as he spoke to me. Also the following night I received a phone call from him stating that he had been thinking about what I needed to do and that he had thought of a better way and that he was sending me a copy of the keying instructions to allow me to change what I had been doing to make it easier, now that's what I call back-up service.

So for my own particular DTP needs I think Goldmark have got it about right for this particular program, as to the overall price, one must assume that there is probably not an extremely large market for this program, as there would be for "games", and also the fact that very few people are going to buy the complete set of disks, then I would think that this price has to reflect the time and trouble that Brian has taken to get these pictures available for use on the CPC.

As to the recent accolades given out in AA for excellence of sales services, my own are:

Goldmark, for response time on delivery; Dowling Computers, who do not advertise with you, where I bought my Star LC10 Printer; Siren Software, again for response time; PCW World, and David Wild, although

his PD disk was a while in coming he did enclose a note of apology, which was greatly appreciated.

**David A Calero  
Rochester**

*AA: Perhaps the best way to answer this letter is to print the following one...*



● **Goldmark's clip-art: Great value, says David Calero. Better from the public domain, says Dave Havard.**

I was very interesting in the recent review you did on the Goldmark Clip Art Library.

Like you, I was numbed by the price, and although I found the prospect of such a vast range mouth watering, I was not prepared to pay such an amount.

I decided to follow up on your comment that it was basically PD software, and contacted several PD libraries.

PCW World came up trumps, with over 20 disks-worth of clip art for Stop Press and other formats. I rang them to

check CPC compatibility, and they offered me a disk to test.

To cut a long story short, I can confirm that PCW World, regular advertisers in your magazine, carry an extensive library of clip art, which is compatible with the CPC and Stop Press. What's more, at only £4.95 per disk (which they supply), less for members, it is less than half the price being asked for by Goldmark.

Such service as I have found, and at prices like these, I felt it prudent to pass this information on to you, so that you in turn can inform your readers. The titles in question are:

- G 106 1 disk
- G 113 2 disks
- G 116 16 disks
- G 119 2 disks

Between them they mount up to over 2,500 pieces of clip art.

**Dave Havard  
Fareham**





LC10 Colour printer was what I was looking for because it was easy to use and relatively cheap. I knew when I bought it that the colour function was limited by the lack of available compatible software. However, after adapting Tasword 464 I was able to print full colour text, although as yet I am unable to print colour graphics because of the lack of a colour screen dump program for the Amstrad CPC 464 on cassette. Please, does anybody know of a company which has marketed such a piece of software, or a way round this problem?

**Andrew Glitherow**  
21 Outfields Drive  
Cropston  
Leicester  
LE7 7HA

AA: *Hmm. There must be thousands of teeming people out there who know the answer to this knotty little puzzler. If so, write to Andrew at the address printed.*

**● To upgrade or not to upgrade...?**

I have been thinking of upgrading my CPC 6128 for a while, and after seeing the new 6128 Plus on the TV I thought maybe I should go for one of those. But at the moment I am unsure and need some questions answering:

1. How much could I ask for my CPC 6128 (with colour monitor)? It is in excellent condition.
2. Does the new 6128 Plus have all the functions that the CPC 6128 has (plus any more)?
3. Can you use existing CPC 6128 disk software on the 6128 Plus, and also could I use my joystick on the new machine?

**Andrew Gauton**  
Warrington

AA: *And as if by magic, we provide the answers:*

1. *As a rough estimate, second-hand prices for existing CPCs will be around half the original price. Thus your 6128 and monitor will be worth £200 (if it is colour - a mono screen will fetch £150). Please note that these figures are only estimates.*
2. *There is no cassette port built into the 6128 Plus. Of course, there is a cartridge port, so you can plug in console-style cartridges (such as can be used with the GX4000) and play them instantly. This is possibly the greatest asset of the Plus range. They are effectively both a GX4000 console and an updated CPC. Apart from these major differences, the machines retain a lot in common.*
3. *The new 6128 Plus would seem to run the vast bulk of CPC 6128 software. When we hear of games which are not compatible with the 6128 Plus, we'll let you know.*

*And finally, your joystick will work perfectly with the 6128 Plus. There are, in fact, two joystick ports, so two players can wiggle at the same time. Ideal for two-player wiggling-type games! The Plus range come complete with console-style joypads, which have two fire buttons for extra permutations with certain games.*

**● Ribbon development**

I liked your story about your "Old Man Ribbon", which had been re-inked 720 times. However rather than plug a commercial spray re-inker probably costing £8 to £12, let me tell you how I achieve the same result for only 85p.

First, this only works with DMP-2000 or similar ribbons, where the ink is held on a felt wheel around which the ribbon runs. Thus having made sure you have the correct ribbon, pop down to my local stationery shop and buy a bottle of Stephens Endorsing Ink for 85p. This is the ink used for re-inking rubber stamp pads.

Now remove the ribbon from the printer and carefully prise off the top of the ink wheel box using a small electrical screwdriver. Inside, you will find a felt ink wheel on which rest two small knurled rollers. The printer ribbon runs outside the two rollers, pressing them onto the wheel to pick up the ink.

A few drops of the endorsing ink should be applied to the felt ink wheel - not too much, it's strong stuff. After allowing a few minutes for the ink to soak in, clean off any surplus with a tissue and replace the top of the box, taking

care to ensure that the knurled rollers are in place.

If your ribbon has gone bone dry, you will have to moisten it by placing a drop of ink on a saucer. Hold the ribbon in the ink with a finger (messy) and pull it through with your free hand. Once again, mop off the surplus, place the ribbon on a newspaper and dab it with tissue.

Now pop the ribbon back in the printer and test your new ribbon. This can be repeated hundreds of times with your one 85p bottle of ink. Amstrad Action will be able to vouch for the quality of the printing in this letter.

**John Chambers**  
Stafford

AA: *The print quality of the letter sent to us by Mr Chambers is indeed very high. This does therefore seem to be a very cost-effective solution to the re-inking problem.*

*It does require a little care, as do many fittings with printer ribbons, because they have a tendency to unravel and wander off in all directions.*



**WANTED!**

**Editors**  
**Sub-editors**  
**Staff writers**

- Launched in 1985
- Now over 125 staff
- 10 national newsstand magazines
- Market leader in computer titles
- Exciting launch plans
- Britain's fastest-growing publisher

Britain's fastest growing publishing company, Future Publishing, is looking for exceptionally talented and ambitious magazine staff to work on existing titles and planned launches.

Future, based in beautiful Bath, already publishes *Amiga Format*, *ST Format*, *New Computer Express*, *Commodore Format*, *Your Sinclair*, *Amstrad Action* and *Sega Power*, as well as *PC Plus*, *8000 Plus* and *Mac Publishing*.

In return for your blood, sweat etc etc the company offers a good salary, an excellent working environment and the opportunity to take on new and exciting challenges as Future continues to expand.

If you have good reason to think Future needs you, send your CV, together with examples of published work - or 500 words on "What magazines are for" - to Greg Ingham at the address below. (Editors: send copies of recent issues.) Do it today if you know what's good for you.

Future Publishing Ltd, Beauford Court, 30 Monmouth Street, Bath, BA1 2BW Tel: (0225) 442244



# THE 16 BIT CLASSIC NOW ON AMSTRAD & SPECTRUM



Available on  
Amstrad &  
Spectrum  
cassette & disk

PSYGNOSIS  
© 1990 PSYGNOSIS

## SHADOW OF THE BEAST GREMLIN®



Screen Shots from Amstrad format.



Screen Shots from Spectrum format.







# On the Grapevine...

News, views, previews, scandal, gossip... the place where we bring you up to date on who's who and what's what in the big, wide world of computer entertainment...



## Gazza calls it off

Adam was getting ever so excited. He was so looking forward to meeting the great man for real. His dreams, though, were shattered when Gazza got punched on the hooter by Steve McMahon, and ran off to Newcazza to be with his Mam.

There was to have been a big press do at White Hart Lane (home of Tottenham Hotspur, Gazza's team), to promote Gazza's new footie game called *Gazza*. Unfortunately, the footie star suffered a broken nose, and couldn't make it. It was especially disappointing because we intended to get Mr Gazza to autograph an exclusive box of Kleenex. Never mind, we'll just have to go without (boo hoo).

## Disks on budget

People with disk drives must be fed of of budget games always coming on tape. Electronic Arts, which hasn't been terribly active in the Amstrad scene of late (boo!), is relaunching its range on budget - on both cassette and disk.

Initially, two games will be released on EA's Star Performer label. There's *Chuck Yeager's Advanced Flight Trainer* (Mastergame, AA42), and *Skate or Die* (the less said the better, really).

The tape-based games will sell for the usual £2.99. If you want the disk versions then you'll be expected to shell out £6.99.



● Now you can fly like Chuck Yeager for £6.99.

## It's a stunner!

One of the most exciting games in the arcades at the moment is *STUN Runner*. (What do you mean, you've never heard of it?) You pilot a motorcycle-like machine extremely quickly through lots of tunnels and try and beat all the other vehicles. It has the most amazingly slick 3D graphics, and apparently uses lots of polygons.

"So what", you cry, "there's no way that any home micro version can hope to keep up with the arcade machine."

Ah, well, Domark has realised this, and instead of all those poly-wotsits and stuff, the programmers have turned it into a sprite game in an effort to get things moving along nice and quickly. Look out for the review soon, folks!



● *STUN Runner*: out soon on the Amstrad - but no 'proper' 3D.

## Good God!

You know it's going to be one of those days when you wake up with a severed horse's head on the pillow next to you...

*The Godfather* appeared in 1972, and told the story of a bunch of Italians killing each other. The sequel followed two years later in '74, but it took another 17 years for them to get round to making the third one.

*Godfather III* hits the silver screens in March next year.



● Would you buy a used Ferrari from these men?

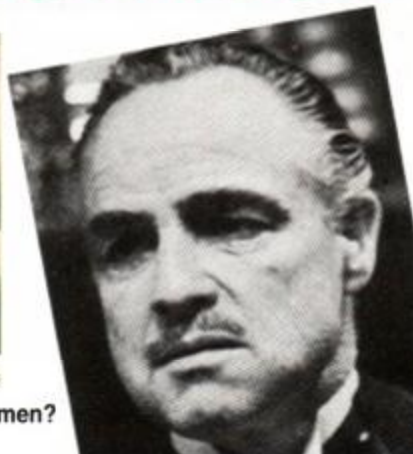

Thanks to US Gold, it'll be appearing on your monitor screens at around the same time. The Birmingham company will really be making the most of this licence, producing both an adventure game and an arcade-style game to appeal to all kinds of gamer.

## Codies compilations

Fans of the *Dizzy* games will no doubt be all eggs-cited about the prospect of another *Dizzy* game. The long awaited *Dizzy Four - Magic Land Dizzy* will be in the shops soon. However, the hard-boiled hero will be released on a compilation containing all five *Dizzy* games to date (including the spin-off *Fast Food*).

*The Dizzy Collection* will sell for £9.95 on tape (a disk version won't be available). Now, this may be attractive for those new to the *Dizzy* games, with the games working out at less than £2 each. However, *Dizzy* fans who own the other games already may not be quite so eggs-tatic about buying the compilation. Alas *Dizzy 4* won't be released on its own as a budget title until after Christmas.

Codemasters has another full-price package due out soon. Called *Megahot*, it comprises the eight best-selling Codies budgies (excluding, of course, the *Dizzy* games).

The line-up includes *Mig 29*, *BMX Sim*, *Grand Prix Sim*, *ATV Sim*, *International Rugby Sim*, *Fruit Machine Sim*, *Advanced Pinball Sim* and *Pro Tennis Sim* (that's enough sims - ed).







Before the advent of the home computer, and all those soccer sims with it, people used to spend their time flicking bits of plastic around a lumpy pitch on the living room carpet.

In fact Subbuteo is still an incredibly popular pastime. Over five million people play around the world. And you'll soon be able to join them - without moving away from the keyboard of your favourite computer.

Electronic Zoo has been granted the licence for the computer version of Subbuteo. Now that may seem a strange idea for a footie game - but not according to Electronic Zoo. The company points out that there have been hundreds of attempts at simulating soccer on computers - with varying degrees of success. Rather than trying to simulate an eleven-member team sport - pretty difficult to do successfully - it is interpreting a game that's designed for just one or two players.

● **Subbuteo shocks** - ten things you didn't know about subbuteo (and probably didn't want to either)

- 1 The longest game of Subbuteo lasted over four days.
- 2 A Subbuteo league has been formed by Carmelite nuns in Italy.



● Just like the real thing! (Subbuteo players fall down and roll around a lot, too.)

3 The name Subbuteo is from the Latin name for Hobby Hawk - *Falco Subbuteo*.

4 The game was invented by a Mr Peter Adolph in 1947.

5 The original Subbuteo players were made out of cardboard. Their bases were coat buttons.

6 Early Subbuteo sets did not include a playing cloth. Instead, instructions were given for drawing one out on an old army blanket.

7 The most popular Subbuteo team is Liverpool.

8 Footballing brothers Bobby and Jack Charlton are respectively Presidents of the UK and Irish Subbuteo Associations.

9 More than 100 million Subbuteo figures have been manufactured.

10 Over 700 different strips have been available since the game's invention. (There are around 500 now.)

**WIN! WIN! WIN!**

Electronic Zoo is celebrating the launch of *Subbuteo* by throwing ten copies of the real *Subbuteo* table football game in your direction.

All you need to do to enter is answer these three sporting questions (you'll need to be on your toes, though, 'cos they're a bit tricky):

- 1 What popular sport does table football emulate?
  - (a) Football
  - (b) Tennis
  - (c) Caber-Tossing

2 What well known sport is featured in the TV programme *The Match*?

- (a) Synchronised Swimming
- (b) Football
- (c) Golf

3 What sport did the famous footballer Nobby Styles play?

- (a) Rugby League
- (b) Curling
- (c) Football

Entries on a postcard to: Flick Off Comp, Amstrad Action, Beauford Court, 30 Monmouth Street, Bath, Avon BA1 2BW. Make sure that they arrive by 31st January 1991. The usual rules apply. Multiple entries will be burned and so on.

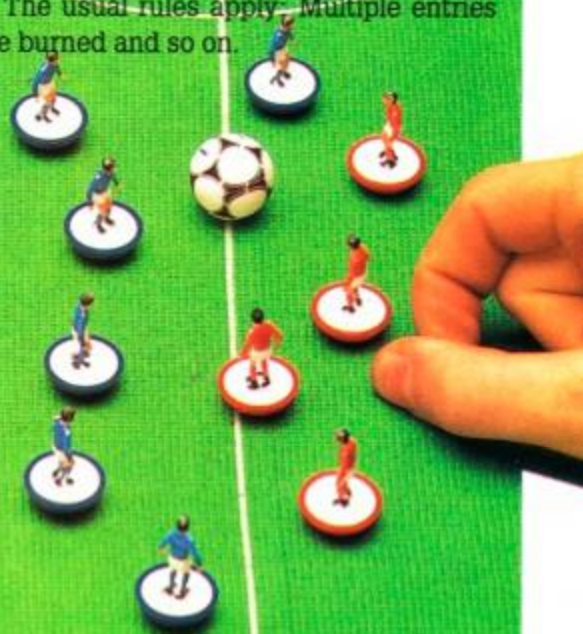

**Gremlins 2**

Those lovable little creatures are back again. You know, the cute cuddly ones that turn in to ferocious fiends should you accidentally feed them at the wrong time...

The whole of the AA team sadly missed out on the film (*I didn't, but I wish I had - ed*), so we cannot divulge any of the plot. We'll can make a guess, though. The gremlins are probably causing all sorts of mayhem, and the hero, we anticipate, ends up killing them all.

We were sent these screen shots by Elite, the company producing the game of the film. It looks good, and we'll

tell you what we thought of the game itself in the new year.



**Navy Seals**

Coming soon on the console will be *Navy Seals* from Ocean. As far as we know the game has nothing to do with blue-coloured marine mammals. Instead it's based on a film that nobody seems to have heard of. Apparently, the Navy Seals are a bit like the SAS, only they're American, and are part of the Navy, rather than the Army.

The plot of the film is that some countrymen have been taken hostage and it's the Seals' job to get them out them. Where there are hostages, there are terrorists too, so lots of those have to be killed.

In the game, there's plenty of slaughter, to be sure, as your character makes his way across the platform-based levels. An added twist is that crates of Stinger missiles need to be blown up with bombs planted en route.

Ocean seems to be making the most of the console's advanced features, from what we saw of the development version. The sprites are big and detailed, the scrolling is smooth and fast, and there's plenty happening on screen at once. We expect to see the Seals surface after Christmas.

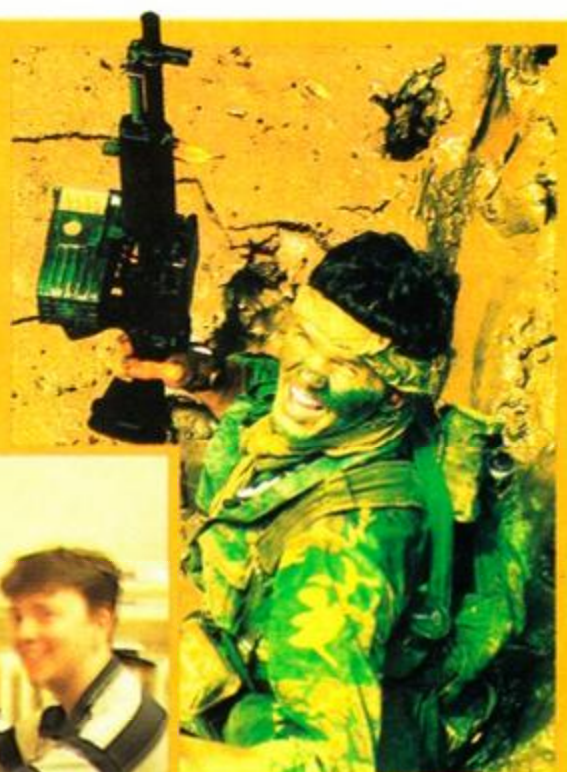

● Kill kill kill! Oh, er, and don't forget the hostages...



**SUPER  
SKI**

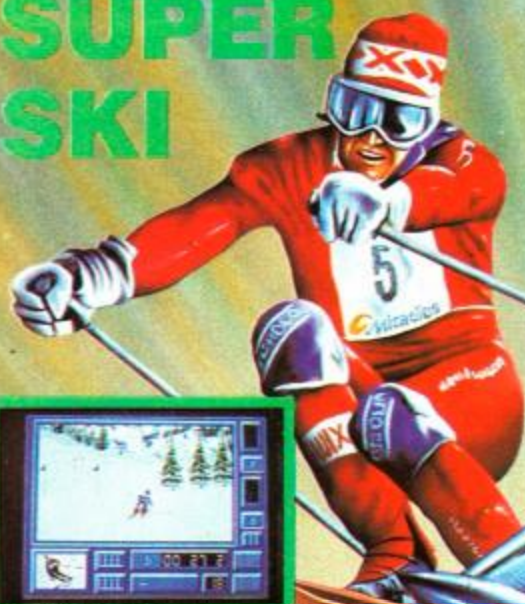

**BOMBER**

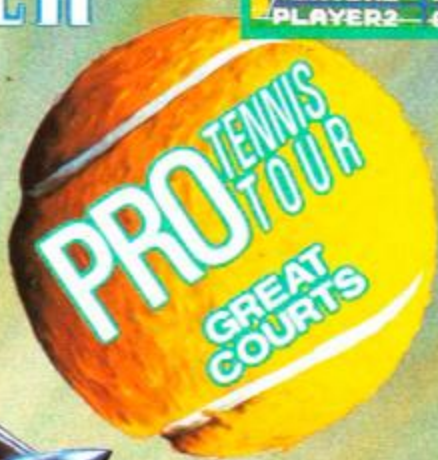
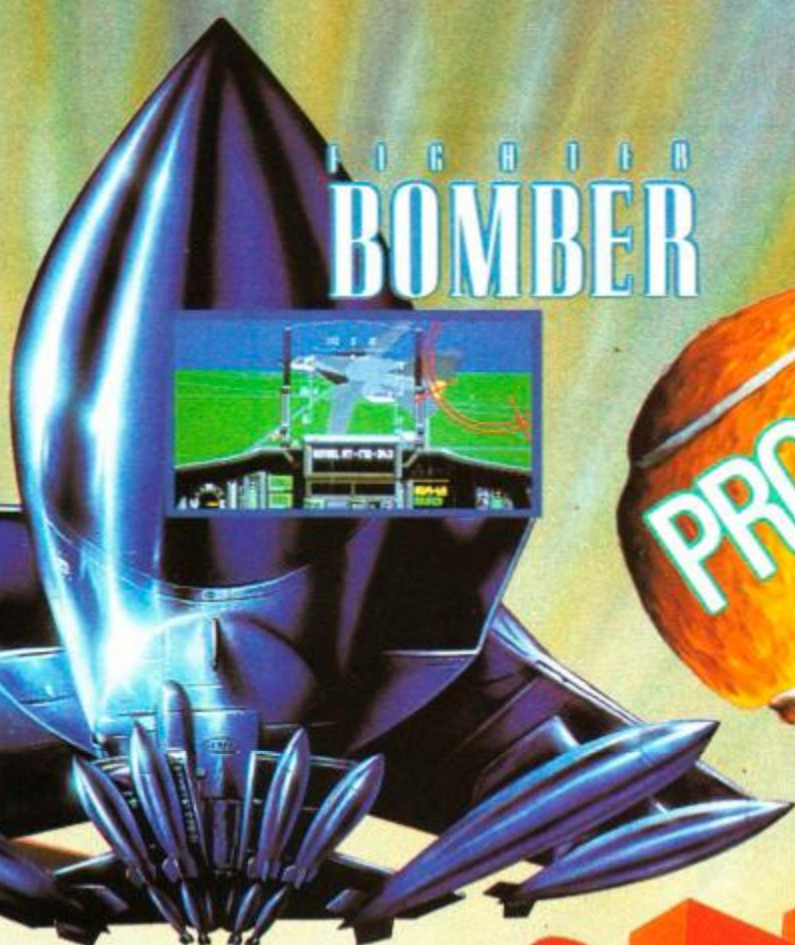

# CHALLENGERS

**KICK  
OFF**

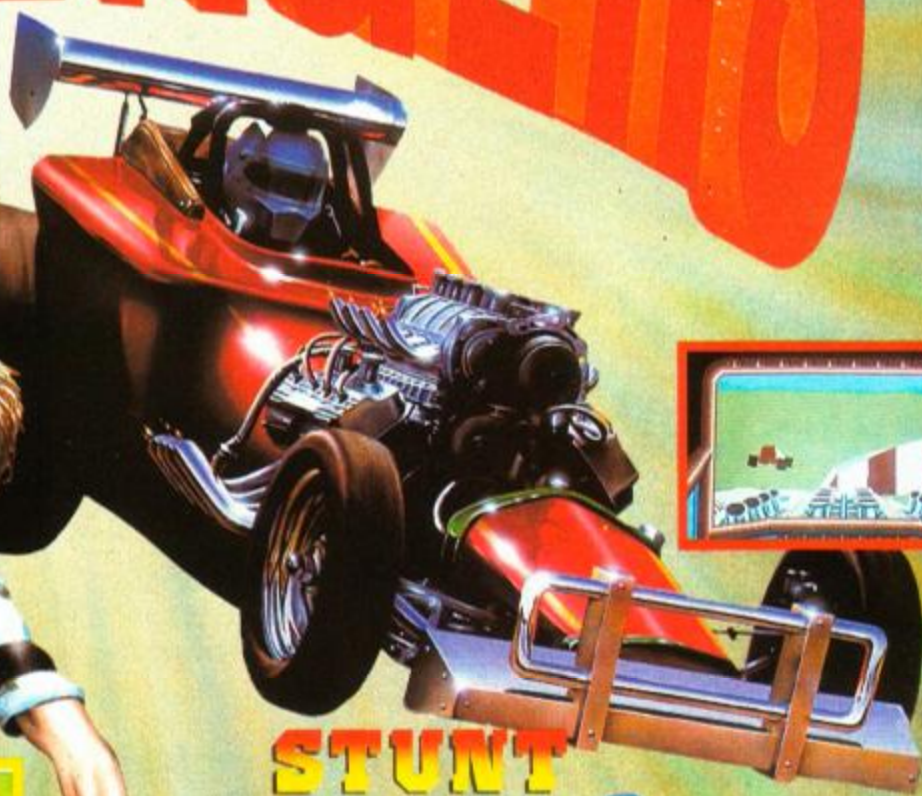
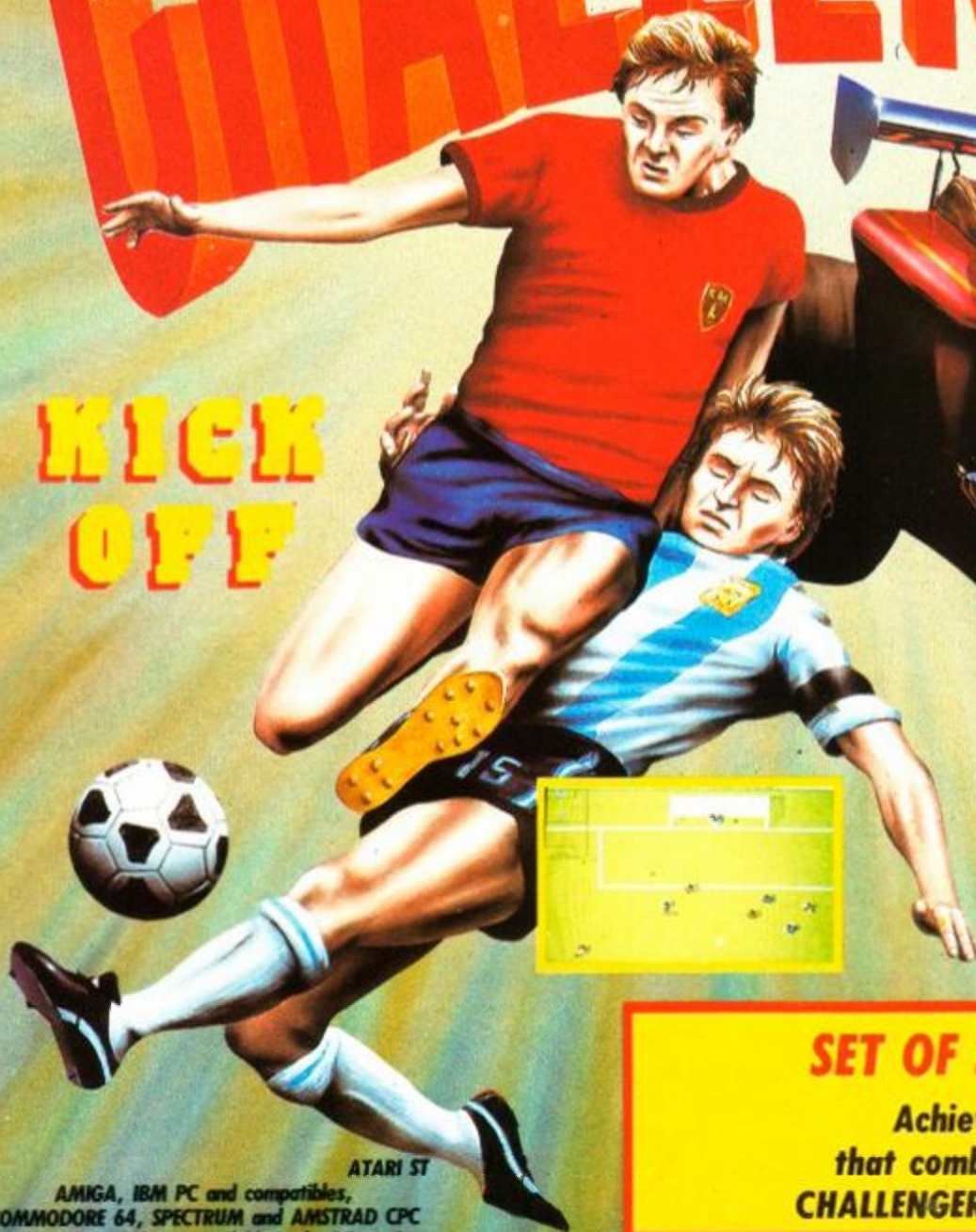

**STUNT  
CAR  
RACER**

UBI SOFT UK  
SADDLERS HOUSE  
100 READING ROAD  
YATELEY CAMBERLEY  
SURREY GU17 7RX  
Tel. 0252 860 299

**SET OF SIMULATIONS all versions.**  
Achieve excellence with this superb set  
that combines the greatest SIMULATION HITS !  
**CHALLENGERS ! Definitely RESERVED FOR THE BEST !**

ATARI ST  
AMIGA, IBM PC and compatibles,  
COMMODORE 64, SPECTRUM and AMSTRAD CPC  
Note 1 ! KICK OFF is not available in the PC version.  
Note 2 ! In the SPECTRUM version STUNT CAR  
RACER and SUPERSKI are replaced by CARRIER  
COMMAND, P47 and RICK DANGEROUS.

**UBI SOFT**

Entertainment Software

PRO TENNIS TOUR © 1989 Ubi Soft  
BOMBER © 1989 Ubi Soft  
KICK OFF © 1989 Ubi Soft  
STUNT CAR RACER © 1989 Ubi Soft  
SUPER SKI © 1989 Ubi Soft  
CARRIER COMMAND © 1989 Ubi Soft  
P47 © 1989 Ubi Soft  
RICK DANGEROUS © 1989 Ubi Soft





# 50 BEST GAMES OF THE YEAR: Part 2

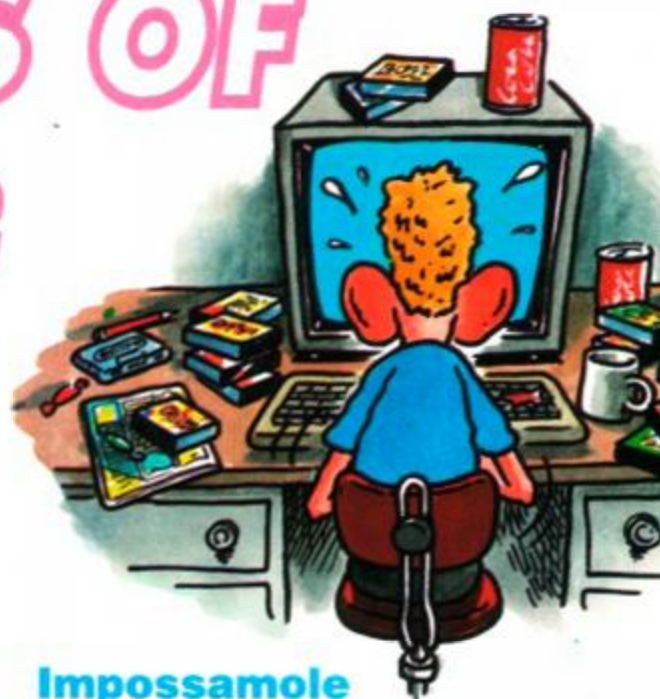

## Impossamole

### Gremlin

66%

AA58

"Monty games haven't changed. They've been given a shot in the arm but the format has been mined to exhaustion in previous versions."

Harsh words indeed, especially since *Impossamole* was actually quite a good arcade platform puzzler. In it, our furry friend had to find and destroy five tough Guardians on five equally tough worlds. The action didn't go down too well at the time, the supremely frustrating *Impossamole* being rated a lowly 66%.

But what do we think now? *Impossamole* isn't as good as *Rick Dangerous II*, but it's perilously close to a Rave...

## Klax

### Domark

89%

AA58

"...Terminal mindbending is the outcome, as is complete and total addiction. If you ever manage to score a Klax your life will never be the same again, the game quickly becomes an obsession."

*Klax* followed in the *Tetris* vein, that of using a very simple principle coupled with arcade-style reactions to provide a stupidly addictive little game. In *Klax*, variously-coloured tiles flip towards you down a table and you have to collect them (up to five at a time) on a paddle and then drop them into a pit so as to form horizontal, vertical or diagonal lines of the same colour. These tiles then disappear. Each successive level poses a different, tougher challenge, and you could be playing – and swearing at – this one for months.

We game *Klax* 89% originally, but in all conscience it has to be worth a Mastergame.

## AMC

### Dinamic

83%

AA58

"With nine hits before you die and five lives, it looks as if *Dinamic* has finally got the difficulty level right. *AMC* is easy enough for the beginner to start while being hard enough to test the best at the finish."

Yes, it's part 2 of *Amstrad Action's* huge end-of-year retrospective. What are the 50 best games of 1990? ROD LAWTON concludes the round-up. This month: July to December...

humans play at once as well as adding other bells and whistles to the original concept.

*Bloodwych* is pretty well unique. Possessing unrivalled immediacy and realism for a role-playing game, it provides a huge challenge for determined adventurers. Good one, Image Works.

**CONSOLE CLASSIC**

## Burnin' Rubber

### Ocean

92%

AA60

"When you've finished admiring your new console and pretending it's something out of *Stingray*, you are ready to play *Burnin' Rubber*, the first ever Amstrad console game. Could this be the start of a new era of gaming?"

*Burnin' Rubber* is the free game supplied with the GX4000 console and Plus machines. But although it's free, that doesn't mean it's no good! In fact, *Burnin' Rubber* is the finest racing game ever seen on an Amstrad. You drive a le Mans car round a twisting, dipping circuit, through tunnels, past other cars... and end-over-end through the scenery, more than likely. There's nothing new in this game, just sheer speed, playability and graphic polish. Two things are truly spectacular. Your 16-colour hi-res hardware sprite, and the subtly shifting colours you race on



● *Burnin' Rubber* – the best driving game yet?

through the dusk and into the night.

So if it's so good, why only (!) 92%? Well, *Burnin' Rubber* does get gradually tougher as you go on, but basically very little happens. You crash or you keep going, that's all there is to it. Nigel Mansell can go home from Monaco after two hours, Derek Bell can leave le Mans after twenty-four, but a really hot *Burnin' Rubber* racer could go on indefinitely...

You know it's a funny thing with games. There are some which grab you by the throat and shout "Play Me!" straight away, and others that you don't really notice very much at first but sort of sneak up on you and gradually work their way into your affections without you really noticing.

And what's just as funny is that quite often it's the immediately spectacular games that you lose interest in first and the subtler ones that you're playing later. Which is one reason we're bringing you this end-of-year round-up, so that we can right a few wrongs and set a few records straight. It's also a great opportunity to dig out all our favourite games and play them again on the pretext of working...

So here, then, is part 2 of our round-up, where we look at all those hits that came our way between July and December. Did they all stand the test of time? Did they all get a fair deal? Do we still play any of them now?

Most importantly, though, it's YOUR chance to cast your vote. Once you've read what we think, turn to page 45 for our special voting form whereby you can elect the year's best game.

Ready? OK, here we go with the second half...

## Bloodwych

### Image Works

92%

AA58

"*Bloodwych* could never be called exciting, although life can get fraught. It's the mental exercise that's the fun. If you are to solve the mystery of *Bloodwych*, then every square inch of the fortress will have to be searched."

The original *Dungeon Master* was a huge hit on the 16-bit machines. Described cruelly by some as being about as exciting as wandering around an NCP car park, it gave you the task of guiding a party of warriors, wizards and the like around a labyrinth of tunnels, battling all manner of monsters and hazards. *Bloodwych* is the follow-up, and lets two





Another walking, stalking death-dealing scroller, *Astro-Marine Corps* is also yet another tough, good-looking blast from Spain. Eight levels, collectable weapons and large, impressive foes all go together in a well planned and well constructed game. And that's about it, basically.

AMC got a Rave back in AA58, and it looks just as good now.

### Fighter Bomber Activision

89%

AA59

"Happiness is a laser-locked target. Fear is a locked SAM. Trouble is they tend to coincide. *Fighter Bomber* gives desktop pilots a taste of both with an adventure in techno-war..."



● *Fighter Bomber* mixed flight sim accuracy with arcade action.

The trouble with most flight sims is that they're dull. The trouble with most airborne arcade games is that they're simplistic. *Fighter Bomber* attempts to combine the best features of both.

The only thing that stopped it scoring a Mastergame was the limited number of missions, and the fact that novice pilots might never persevere long enough to become aces.

### Stunt Car Racer Micro Style

96%

AA59

"*Stunt Car Racer* is simply the best. Drive baby drive, put that pedal to the floor and go crazy. Why? Because you have to be slightly touched to even consider taking on this crowd of speed nutters..."

*Stunt Car Racer* made even the formidable *Hard Drivin'* look as if it was standing still. Using similar techniques - honest, straightforward, no-cheatin' 3D graphics - *Stunt Car* economised on on-screen detail but made up



● *Stunt Car Racer* - minimum graphics, maximum thrills!

for it in speed and playability. You race around a series of stunt tracks that make roller coasters look like a pram ride in the park, competing against opponents even crazier than you are...

We must have thought it was good - we gave it a massive 96% back then! Worth it for its playability and speed, but we're not so sure about the graphics any more. They really were on the thin side of non-existent.

### Escape from the Planet of the Robot Monsters

Domark

78%

AA59

"Overall, *Escape from the Planet of the Robot Monsters* is a polished and entertaining game. The one-player mode is good, but the simultaneous two-player option will make for many a long hour of happy blasting."

This game harks back to all those isometric 3D epics of yesteryear in its style. Your job is to rescue a bevy of beautiful female hostages from swarms of evil robotic guardians in a multi-screen bash-em-up. Graphics are thoroughly up to date, and a two-player option does more than simply double the fun.

We rated this one just below a Rave, but we think we were a little cruel - it really is good enough to deserve that rare accolade.

### Lords of Chaos Bladesoft

84%

AA59

"*Lords of Chaos* has one hell of a reputation to live up to after *Laser Squad*. It's a complicated beast, and a lot of manual-reading and getting killed is called for before you start to achieve anything."

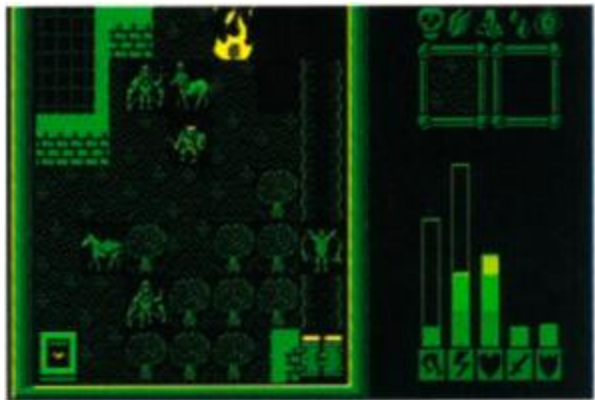

● *Lords of Chaos* was *Laser Squad* with magic.

*LOC* is a role-playing game with excellent seen-from-above graphics and enough gameplay to last you a lifetime. Each character moves individually and possesses his or her own characteristics. The trouble is, how could it follow *Laser Squad*? The last thing it needed was more gameplay...

We gave *Lords of Chaos* 84%. Without *Laser Squad*, though, it would probably have scored a Mastergame...

### Deliverance Hewson

89%

AA59

"With perseverance it's possible to progress, each time getting a screen or two deeper into

the game and further out of Hell. If you're looking for one of the stiffest arcade challenges ever, *Deliverance* is the answer. It's a hard one but beatable, eventually."

Raff Cecco is one of the industry's legendary programmers. His distinctive graphics have ensured him a cult following on the CP



● *Deliverance* was great-looking but oh so tough.

and *Deliverance (Stormlord II)* is his best yet. It's a platform shoot-em-up which needs ultra fast reflexes, rapid tactical thinking and almost inhuman perseverance. Very tough indeed.

*Deliverance* scored 89% - almost Mastergame. Despite the polish and the graphic excellence, it loses out on sheer difficulty

### International 3D Tennis Palace

81%

AA59

"...the emphasis heavily on tennis first, the second and the international bit following a way behind."

The first time you see *3D Tennis* you're going to think it's somebody's idea of a joke. Drawn in sketchy vector graphics, it looks like an abortive Speccy game of the early '80s. Sure is the price, however, of genuine - and fast 3D. *Palace* has bravely gone for the real approach versus the pretty one, and come out with a tennis sim like no other. Play it long enough and you'll realise that this is serious stuff, a program that makes other tennis sims look like candyfloss.

But what do we think of it now? Well, it scored 81% at the time - those graphics really are off-putting - but if you're talking serious tennis it's got to be the one.

### Monty Python's Flying Circus

Virgin

84%

AA6

"Yes, it's time to don your silly hat, lock the door and put down that Cabinet Minister. You're about to enter an extremely surreal world..."

How on earth can you make a computer game out of a phenomenon like the anarchic disjointed and basically nonsensical *Monty Python*? Well *Virgin* has tried, and come out with a rather good game. It's basically a shoot-and-collect-em-up populated by large numbers of *Python* favourites. Your hero is Mr Gum who is out to reassemble his brain so that



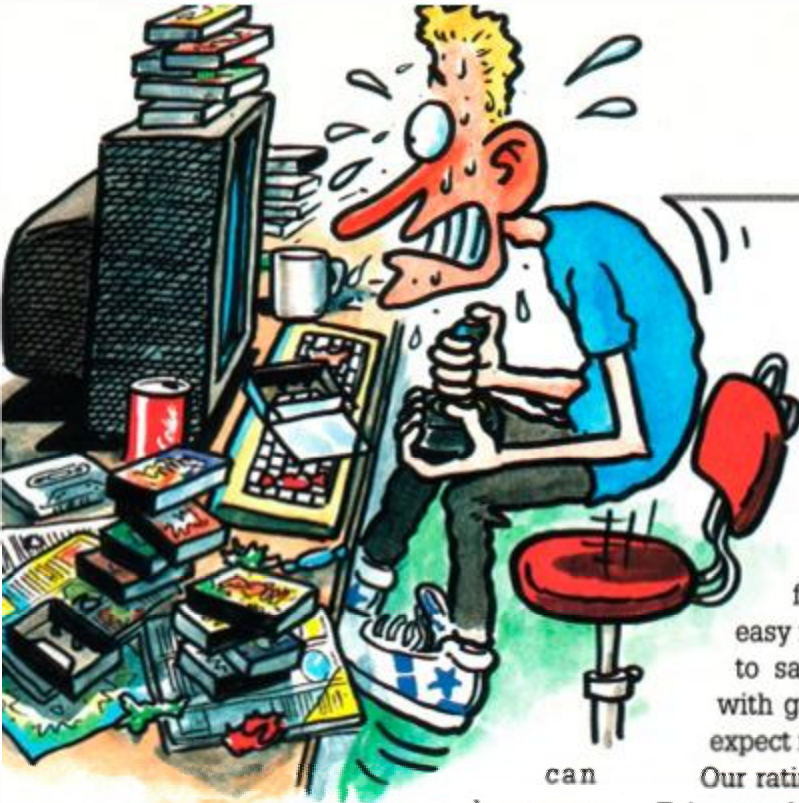

can

become

an accountant. He starts off avoiding a series of 16-ton weights and being followed by a bush with legs, and then he has his head transplanted onto the body of a fish before he goes off collecting tins of spam...

*Python* scored 84% and deserved every bit of it. Absurd and hilarious on the surface, it was also a deep and challenging little game underneath.

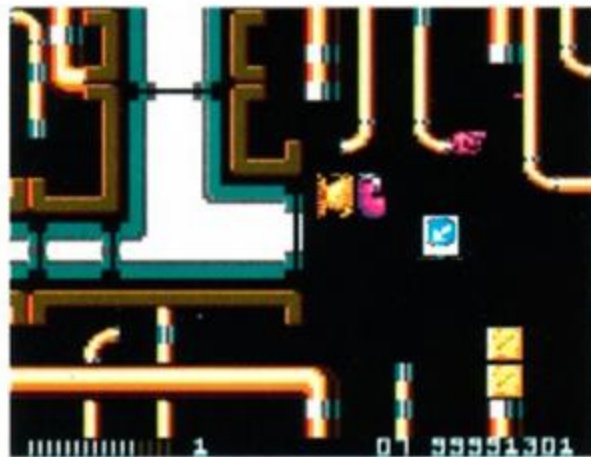

● Monty Python had you collecting tins of spam...

**Iron Lord**  
Ubi Soft  
92%

AA61

"...it stands head and shoulders above the others in the genre. It is fun to play, and wonderful to look at. There is enough here to satisfy the most demanding adventurer..."

*Iron Lord* seems to have been around on the other formats for ages, but has only recently made it to the CPC. To describe it as a graphic adventure/role-playing game would be not to do it justice. Your job is to regain the throne of your kingdom by amassing an army from your land's citizens and leading it against the evil usurper. There are archery matches to win, arm-wrestling and gambling, heroes, villains, battles and everything else you could wish for in a medieval epic.

We gave it a Mastergame, and in its field there's no doubt that there's simply nothing to touch it. A whole world crammed into two disks (yup, it's that big).

**Satan**  
Dinamic  
83%

AA61

"*Satan* is tough, challenging and very playable. The scrolling is smooth and graphically the

game rates very highly. Just be careful that Old Nick doesn't get you..."

As is usual with Dinamic games, *Satan* comes in two halves. Complete the first and you get the password for the second. The idea is that once you've got that far, there's no need for you to have to play the (by now) easy first level again. What more is there to say? A tough platform shoot-em-up with great graphics, as we have come to expect from this Spanish software house.

Our rating was 83%, making *Satan* a Rave. Fair enough, really, because although the game was about as well done as it could be, that style of game has been pretty well done to death by now.

**Night Hunter**  
Ubi Soft  
73%

AA61

"Arcade game standard it ain't, but if you like the idea of a nicely-drawn, atmospheric romp around a big castle, with a bit of thought and a bit of difficulty, give *Night Hunter* grave consideration..."

You normally consider Count Dracula the bad guy, but in this platform suck-em-up it's your job to make sure he gets enough blood to keep him going all through the night. You've got to explore a the rooms and corridors of an old castle for three bits of parchment and five keys which, between them, will get you off that level and onto the next. Oh yes, and you've got to get off the level before dawn, or you crumble away into dust...

We gave *Night Hunter* 73% originally, but that was a bit unkind. The four-colour graphics make up for in detail what they lack in, er, colour, while the characters, animation and sound effects really are very funny. Add to that great playability and you've got a game with really deserves a Rave.



● In *Night Hunter*, Dracula was the good guy!

**Skate Wars**  
Ubi Soft  
80%

AA61

"Excellent graphics and oodles of playability. Not much variety, but the range of hazards on successive levels added to the sheer fun factor makes up for all that."

*Skate Wars* is a kind of ultra-violent ice-

football. The players are encased in spiked steel armour and the ball itself is solid steel. The niceties of tackling are limited to smashing into your opponent hard enough to send him flying, and hazard include concrete mushrooms and bottomless pits

*Skate Wars* scored 80% originally, let down principally by its lack of depth - there are many different rinks, but still the same side-to-side kicking/running/crashing. Having said that, the graphics really are nice and the game so playable that two human opponents could be arguing over it for months.

**PLATFORM PERFECTION**

**Rick Dangerous II**

**Micro Style**  
97%

AA62

"The graphics are a bit blocky, and the game style itself is distinctly old. But the whole thing is done just brilliantly. No question about it - an instant Mastergame!"

*Rick Dangerous II* follows on the heels of its predecessor, a simple platform/ladders/traps puzzling and exploration game with plenty of arcade action. Nothing new at all, but wonderfully executed. *RDII* has even more and better gameplay and a unique game structure that lets you play four of the five levels at will - each of which is a game in itself. And the fifth level? You can only get to it by doing the other four consecutively.

Wow - 97% is a lot to give any game. Does *Rick II* deserve it? Well, we have to say, now that we've had a chance to sit back and look at the thing objectively... well, yes dammit, it does!



● *Rick Dangerous II* was simply the best.

**Fire & Forget II**  
Titus  
84%

AA61

"The only thing left to worry about is the price. Nearly £30 is one hell of a lot compared to the traditional £15 or so of traditional disk-based CPC software."

*Fire & Forget II* is a cross between a racing game and a *Thunderblade*-style shoot-em-up. Your vehicle - a Thunder Master II no less -





can either scoot along the road dwindling towards its vanishing-point on the horizon, or take to the air to attack its foes. You're following a convoy of terrorists on its way to wreck an international peace conference, by the way.

What you've got to ask yourself with a console game is whether it adds enough to the state-of-the-art of CPC gaming to double the price of the software. *Fire & Forget II* would be stunning on the CPC, but for a new generation of games it falls a little way short. It's good, but not that good.

### Sim City Infogrames

82%

AA63

"...a city simulator. Now that may sound like a bit of a daft idea for a game, but just wait 'till you sit down to play it!"

*Sim City* gives you a large, undeveloped landscape, a whole wodge of money, and the



● Building your own metropolis in *Sim City*.

ability to designate commercial, residential and industrial zones, build roads and railways and erect power stations, sports stadiums, ports and airports. Construct a city so wonderful that everyone wants to go and live there – but remember, people don't like pollution from factories, expensive housing or traffic jams, as well as being generally rather finicky...

Very good, but not quite a Mastergame. *Sim City* is endlessly fascinating, but a little sluggish to play and graphically dodgy.

### Italy 1990 US Gold

88%

AA58

"As time ticks on in the World Cup 1990 competition, the Goldies have beaten the offside trap and seem certain to score a winner!"

Yet another World Cup tie-in, *Italy 1990* proved very good-looking and exceptionally playable. Too easy against the computer, but with two humans it was terrific fun.

There were loads of new footie games in 1990, but none which combined both graphics and playability like *Italy 1990*.

### Time Machine Activision

76%

AA62

"This form of time travel can get very frustrating as you puzzle your life away, but if you're

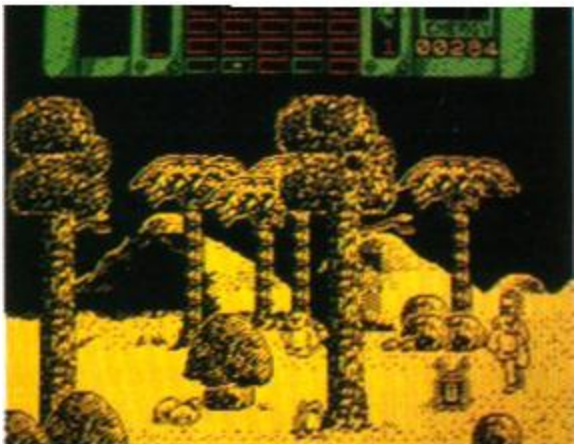

● *Time Machine* – 3D graphics, 4D gameplay...

not too bothered by Speccy ports and silence, and if you enjoy being flummoxed, step into the *Time Machine* and head back to the dawn of history."

We'd never seen anything like *Time Machine*. It's an arcade puzzler set in five different historical time zones over the same bit of landscape. You have to whizz back and forth collecting, moving and manipulating objects in what is pretty well the world's first four-dimensional puzzle.

*Time Machine* fell just short of a Rave when we first reviewed it. The graphics were just too feeble to really carry it off. Now if it had been programmed specifically for the Amstrad (and been given some sound), well...

### Puzznic Ocean

84%

AA62

"*Puzznic* is one of those games based on a very simple idea. Appearances are (as ever) deceptive, though, and underneath it all there's oodles of mega addictive gameplay. You'll be unable to put it down until you've finished."

Ocean has come up with another puzzle game, this time shuffling coloured tiles around until you can get them next to each other so that they disappear. Walls, lifts and all sorts of different layouts over eight large levels will keep you puzzling for ages.

There's enough gameplay to justify its 84% Rave rating at the time, but not enough arcade immediacy to make it a Mastergame.



● Ocean's *Puzznic* was a great brain-teaser.

### Kick Off II Anco

86%

AA63

"*Kick Off II* is simply the most playable footie game to date. While it's still not as polished as other soccer games, it represents a big improvement over the original version."

The original *Kick Off* was fast and playable, but almost entirely devoid of anything

which could be called graphics. *Kick Off I* remedies this in great style, as well as adding new features to boost the gameplay even further.

We liked it so much we gave it 86%. Not quite polished enough for a Mastergame, but probably the year's most playable footie sim.

### CLASSY CONVERSION

### Shadow of the Beast

Gremlin

84%

AA63

"*Shadow of the Beast* is a game we thought we'd never seen on the Amstrad."

There are several levels to explore in this horizontally-scrolling bash-em-up that set the world buzzing with its graphics on the Amiga. With beasties to bash, objects to collect and end-of-level guardians to destroy. The four-colour graphics are detailed and effective, and the gameplay easy enough at the start and tough enough at the end – it's what counts.

The major quibble was the restart point once you were dead – right back at the blinkin' start! That stopped it getting a Mastergame in AA62 and it still hacks us off now. Otherwise, a great conversion.



● *Shadow of the Beast*







# THE BEST GAMES OF 1990: READERS' VOTING FORM

<input type="checkbox"/> 1	Rick Dangerous II .....	Micro Style.....	97%	AA62
<input type="checkbox"/> 2	Stunt Car Racer .....	Micro Style.....	96%	AA59
<input type="checkbox"/> 3	Myth .....	System 3.....	94%	AA55
<input type="checkbox"/> 4	Ghostbusters II .....	Activision.....	94%	AA52
<input type="checkbox"/> 5	Burnin' Rubber .....	Ocean.....	92%	AA60
<input type="checkbox"/> 6	E-Motion .....	US Gold.....	92%	AA57
<input type="checkbox"/> 7	Iron Lord.....	Ubi Soft.....	92%	AA61
<input type="checkbox"/> 8	Bloodwych .....	Image Works.....	92%	AA58
<input type="checkbox"/> 9	Castle Master .....	Domark/Incentive.....	91%	AA56
<input type="checkbox"/> 10	Turrican.....	Rainbow Arts.....	90%	AA57
<input type="checkbox"/> 11	Chase HQ .....	Ocean.....	90%	AA54
<input type="checkbox"/> 12	The Untouchables .....	Ocean.....	90%	AA53
<input type="checkbox"/> 13	Jack Nicklaus Golf.....	Accolade.....	89%	AA53
<input type="checkbox"/> 14	Klax .....	Domark.....	89%	AA58
<input type="checkbox"/> 15	Fighter Bomber.....	Activision.....	89%	AA59
<input type="checkbox"/> 16	Fantasy World Dizzy.....	Codemasters.....	89%	AA52
<input type="checkbox"/> 17	Operation Thunderbolt.....	Ocean.....	89%	AA52
<input type="checkbox"/> 18	P-47 Thunderbolt.....	Firebird.....	89%	AA54
<input type="checkbox"/> 19	Deliverance .....	Hewson.....	89%	AA59
<input type="checkbox"/> 20	Italy 1990 .....	US Gold.....	88%	AA58
<input type="checkbox"/> 21	Pipe Mania.....	Empire.....	88%	AA57
<input type="checkbox"/> 22	Rainbow Islands .....	Ocean.....	88%	AA55
<input type="checkbox"/> 23	Fiendish Freddy.....	Mindscape.....	88%	AA55
<input type="checkbox"/> 24	Kick Off II.....	Anco.....	86%	AA63
<input type="checkbox"/> 25	Puffy's Saga .....	Ubi Soft.....	85%	AA56
<input type="checkbox"/> 26	Lords of Chaos .....	Bladesoft.....	84%	AA59
<input type="checkbox"/> 27	Shadow of the Beast .....	Gremlin.....	84%	AA63
<input type="checkbox"/> 28	Puzznic .....	Ocean.....	84%	AA62
<input type="checkbox"/> 29	Monty Python's Flying Circus.....	Virgin.....	84%	AA61
<input type="checkbox"/> 30	Fire & Forget II .....	Titus.....	84%	AA61
<input type="checkbox"/> 31	AMC .....	Dinamic.....	83%	AA58
<input type="checkbox"/> 32	Satan.....	Dinamic.....	83%	AA61
<input type="checkbox"/> 33	Sim City .....	Infogrames.....	82%	AA63
<input type="checkbox"/> 34	World Cup Soccer - Italia '90 .....	Virgin.....	81%	AA57
<input type="checkbox"/> 35	International 3D Tennis .....	Palace.....	81%	AA59
<input type="checkbox"/> 36	After the War .....	Dinamic.....	81%	AA52
<input type="checkbox"/> 37	X-Out.....	Rainbow Arts.....	86%	AA56
<input type="checkbox"/> 38	Hard Drivin' .....	Domark.....	80%	AA53
<input type="checkbox"/> 39	Skate Wars .....	Ubi Soft.....	80%	AA61
<input type="checkbox"/> 40	Dr Doom's Revenge.....	Empire.....	80%	AA56
<input type="checkbox"/> 41	Dan Dare III.....	Virgin.....	79%	AA53
<input type="checkbox"/> 42	Escape from the Planet of the Robot Monsters.....	Domark.....	78%	AA59
<input type="checkbox"/> 43	Kick Off.....	Anco.....	78%	AA55
<input type="checkbox"/> 44	Oriental Games .....	Firebird.....	78%	AA56
<input type="checkbox"/> 45	Moonwalker .....	US Gold.....	78%	AA52
<input type="checkbox"/> 46	Time Machine.....	Activision.....	76%	AA62
<input type="checkbox"/> 47	Night Hunter.....	Ubi Soft.....	73%	AA61
<input type="checkbox"/> 48	Pro Tennis Tour.....	Ubi Soft.....	72%	AA53
<input type="checkbox"/> 49	Lost Caves .....	Players.....	71%	AA52
<input type="checkbox"/> 50	Impossamole.....	Gremlin.....	66%	AA58
<input type="checkbox"/> ?	Other (please quote game name)			

OK, you've read our ramblings about the best releases of the past year - but what do you think? We're conducting a reader poll whereby each one of you can vote for your fave of 1990. Simply complete the form below and return it to us by February 28th, and we will compile the definitive readers' chart of 1990. So what are you waiting for? - send it in!

Opposite are the top 50 games of 1990, chosen by the AA end-of-year committee and arranged in order of their original scores. What we want you to do is choose your own favourite out of those listed and put a tick in the box next to it. At the end of February we will be getting all the returned forms together and compiling the definitive games chart of 1990. Done that? OK, now cut out this form (a photocopy will do) and send it off to:

**AMSTRAD ACTION READERS' CHART, AMSTRAD ACTION, BEAUFORD COURT, 30 MONMOUTH STREET, BATH, AVON BA1 2BW**

Don't forget, we want these coupons in by the end of February. And as a little inducement to you all, ten readers will be chosen at random and sent a special mystery gift for their troubles...

If you want the chance to win this freebie, just jot down your name and address here:

Name .....

Address .....

● Please choose one game only, because if you start picking your top fives we're not going to know our ?'les from our elbows...



# Forum

Professor Waring wades through another sackful of techie troubles...

Troubled by technology? Baffled by the basics? Have you got a problem or question that you just can't find the answer to elsewhere? Perhaps you have a tip that other readers will find immensely useful. Forum is the place where those problems get solved, those questions get answered, and those tips are passed on. Write to Forum, Amstrad Action, Future

## ● Copy Cat

Help! I've been trying to write a machine code routine for a program that I've been working on. I want to copy a screen from one place to another, the problem is that my routine is just not fast enough. It has to happen within one screen refresh. (It's for a game I'm trying to write, and at the moment it flickers like crazy.)

My routine goes like this:

```
LD HL,8000
LD DE,8C000
LD BC,84000
LDIR
```

I've tried variations to make it quicker, but nothing I do seems to make much difference. I do hope that there is a way - I'm tearing all my hair out!

Jack Spanney  
York

Actually, Jack, the quickest way to copy the

Publishing, Beauford Court, 30  
Monmouth Street, Bath BA1 2BW.

All technical queries should be sent to this address. Due to the pressures of producing the best mag around, we are unfortunately unable to answer telephone enquiries. For the same reasons, we cannot enter into any personal correspondence. Don't enclose SAEs with

screen memory is not to copy it at all! Instead you use a technique that has the appearance copying the memory, but in reality it does no such thing.

The screen memory is simply a bank of normal RAM. There is a video chip that converts the RAM into a picture. This can be programmed to read the screen from different memory locations, either at &0000, &4000, &8000, or the default address, &C000. These are changed by altering the HD6845 chip's start address registers:

```
LD BC,ABC0C
OUT (C),C
LD BC,ABDxx ;xx=800,840,880,&CB depending
              on RAM page
OUT (C),C
```

In BASIC try this to simulate it:

```
10 OUT &BC00,&C:OUT &BD00,0
20 IF INKEY="" THEN 20
```

your letters - they'll end up in the bin.

We try and answer as many letters on different subjects every month but because of the sheer volume of letters we get, we cannot guarantee to print every letter we receive. Rest assured that all your letters are read, and we select those to try and encompass as wide a variety of topics as possible...

```
30 OUT &BC00,&C:OUT &BD00,&C0
```

Note that this doesn't physically move the contents of the screen at all. It merely switches whereabouts the video is read from. It's commonly used by games programmers in a technique called 'flipping'.

Two screens are used. One screen is built up whilst the other is being displayed. When the computer has finished drawing up the hidden screen, they are 'flipped' using the above machine code routine. The hidden screen becomes the displayed screen. The old displayed screen is cleared, and the next screen is built up. This process is repeated many times a second, and results in smooth updating of computer screens.

The advantage of this method is that the screen appears to redraw instantaneously. Only a couple of instructions are involved, and the effect is smooth, flicker-free animation. The disadvantage is that it requires huge amounts of memory - two 16K screens, that's half the computers memory.

I hope you haven't lost too much hair.

## ● Bouncing balls

I hope you can help me. I am trying to get ball bouncing around the screen within a square area, but I am having problems getting started and wondered if you could help me.

I buy AA regularly and if possible could you help me with a poke as well. The game Rockford from Mad Games and there is an address to write to on the game card.

I hope you can help.

Mr K Rowar  
Manchest

Here's a quick lesson in writing a bouncy ball routine.

The ball will have two co-ordinates, one on the horizontal and one on the vertical axis. These will be incremented or decremented depending on the direction that the ball is travelling. When the ball hits the boundary of the pre-defined area, it will change direction.

## ● Give us a poke...

I have just bought an Amstrad CPC 464, and although I have read the manual provided, am not much wiser. At the moment I am just using it for games so I started buying your magazine for help, tips etc.

Unhappily, I do not understand how to put in the cheats, pokes etc, this is very frustrating, could you please please print a "thickies" guide to using them.

I'm sure I cannot be the only new reader with this problem. In time I'm hoping to become more knowledgeable in these matters, but in the meantime, could use some help.

I do not want to resort to "blackmail", but how can I keep buying your mag if I don't understand it!

P.S. Your mag is brilliant, and I do enjoy

reading the letters. (Those that I can understand anyway!)

Marie Butler  
Chesterfield  
Derbyshire

We have recently started a beginners' section, just for people like you. Our new columnist Alex van Damm will answer all your queries about anything you're not sure about in her Ask Alex section. There's no need to feel daft, Alex was a beginner too once (Of course, I never was), and will treat all letters seriously, no matter how trivial they may seem.

I have passed your letter on to her. Hopefully she'll be tackling the prickly subject of pokes in this, or a forthcoming issue.





Here is a simple listing to illustrate how it's done. It's a bit flickery and blocky, but you should get the idea.

```
5 MODE 1
10 x=10:y=10:mdir=1:ydir=1:REM Set the co-ordinates
and directions.
20 LOCATE x,y:PRINT " ":REM Erase the old ball.
30 x=x+mdir:IF x>38 OR x<2 THEN mdir=-mdir:REM Move
the ball left/right. Swap direction if it exceeds
boundaries.
40 y=y+ydir:IF y>22 OR y<2 THEN ydir=-ydir:REM Move
the ball up/down. Swap direction if it exceeds
boundaries.
50 LOCATE x,y:PRINT"O":REM Print that ball.
60 GOTO 20
```

As for your poke request, you'll have to scan Uncle Phil's Cheat Mode pages, and keep your fingers crossed.

### ● Scull and crossbones

I am writing in reference to a letter you carried in AA61 by G A Doyle. In this letter, Mr/Mrs Doyle stated that I was a beginner in the Public Domain business and that I was indulging in 'Secondary Piracy' because I was asking for some PD software in Helpline.

Although I have not been going as long as WACCI, I am not a beginner. In fact, my library has over 80 PD disks, that's more than any other library in the U.K.

Since the programs I asked for are PD, it is not a form of piracy for myself to copy programs from other libraries. Indeed, I have had other PD libraries ordering software from myself, without which, some of them would probably not have started. Also I would like to point out that my PD library was the first to get permission to distribute the *Total Eclipse Trainer Demo*, and since then, other libraries have followed my lead in using the program. So, I would consider them ripping me off on that respect.

Thank you for the taking the time to read this letter and allowing me to defend my PD library.

**Alan Scully**  
Glasgow

Once a piece of software has been donated to the Public Domain anyone is at liberty to pass on a copy to anybody else.

Anyone who runs a library is perfectly entitled to charge a small fee for copying and distributing that software. The prices that PD libraries charge is on the whole barely enough to cover their costs. The time and effort that most librarians put in to the running of their library is enormous.

Alan's library can be contacted at **Scull PD, 119 Laurel Drive, Greenhills, East Killbride, Glasgow G75 9JG.**

### ● Grubby heads?

I have a CPC464, and not many tapes work in it now, we can't work out why. Sometimes a game will load with no trouble, other times the title screen will change colour and then halfway through a block of tape stops and

## ● Presentation is everything

At the moment, and for next two years, I will be doing a BTEC National Diploma in Computer Studies. Just recently I have found out that a large percentage of

the marks come from presentation. I have terrible writing (as you can probably see) and I am worried that I may lose marks because of this (enough of the chit-chat). What I am saying is could you give me advice for a printer that is cheap, has

good NLQ, plenty of fonts, light (as I think my desk is ready to give way) and fairly small (I don't think I've missed anything). Also I would need a good desktop publishing package to allow me to set out the pages and which contains a spelling checking word processor also at a reasonable price.

Finally, could you please print the *Forum* address again as I had to search through mag after mag all the way back to issue 50 to find it!

**Matthew Welford**  
Lincoln

*The Star LC10 should meet with all your requirements. It has a list price of £199, but*

you should be able to get it cheaper via mail order. You could improve your presentation even more by going for the LC200 colour option at an official price of £259,



again shopping around should enable you to buy it for less. Speak to Star Micronics on 0494 471111.

I think you might be going for overkill with the desktop publishing package. They're more suited to producing newsletters and the like, rather

than college work. They can do fancy things, but it will take ages for them to print out your work.

I think you're better off with a straightforward word processing package such as Brunword or Protext. Brunword includes a spell checker as part of the package, and Protext has one as an optional extra. Contact **Brunning Software, 34 Helston Road, Chelmsford, Essex CM1 5JF.** Telephone 0245 252854. Or **Arnor 611 Lincoln Road, Peterborough PE1 3HA.** Telephone 0733 68909.

Just for you, Matthew, *Forum's* address appears at the top of the column.

resets the computer.

Yesterday I tried your cover tape game *Ironman* and it had a 'read error b' in the same place four times. I called my dad over to watch and then it loaded perfectly! I have thought that the tape heads might need adjusting. I have seen head alignment kits occasionally but not recently. Do you know where to get an alignment kit, or somewhere where this could be done cheaply? If the heads are OK, what else could be wrong with our 464? If you could give me any help I would be very grateful.

There are plans in our house of getting a DD1, and Multiface II, but we need the tape to transfer games to disk (NOT LEND OR SELL), only for disk back-up. Is backing up of commercial games OK?

Thanks for any help.

**David Overall**  
Streatham  
London

*It sounds very much like either an alignment problem or possibly dirty heads. Alex ran an article on cleaning and adjusting the heads last issue.*

*If the games you want to save to disk are for your own use only then I can't see any problems. Incidentally, you don't have the automatic right to make back-ups, even if they are exclusively for your own use. However,*

*the software houses are far more concerned about piracy than worrying whether you make the odd back-up.*

### ● Idle thoughts

An idle thought. Why didn't the Amstrad research and development people include a word processing chip in the new 6128s? Or at least space to add, say, *Protext* and *Prospell* inside the machine so it doesn't end up looking like a Christmas Tree?

**David O'Dell**  
Worthing  
West Sussex

*The cartridges that the new machines use normal ROMs inside. There is no reason why a word processor cannot be blown onto the ROM and supplied on cartridge form.*

*However it may be that serious manufacturer's feel that the large number of units that have to be manufactured makes the proposal unfeasible.*

### ● On the level

I have, for several aeons now, used my 6128 and the excellent *Mini Office 2* package for my word processing needs, particularly for school projects and letter writing. It has served me





very well indeed, but now I have dragged myself another rung up the ladder to do A-levels I find myself in need of something a bit better. What I really want is a word processor that will exploit more of the printing capabilities of my DMP2000, such as subscript, italics and underlined printing. I've heard that *BrunWord Elite* is pretty good, but have you any other suggestions?

Another program I need is one that draws and prints mathematical graphs, where you can type in an equation and it does the rest. Up till now I've been using one called *Omnigraph* on the RM Nimbus machines at school. Again, any suggestions?

Finally, many are the evenings when my *Bubble Bobble* tape has failed to load, and unfortunately it doesn't seem to like the Multiface 2. Does anyone know where I can get a disk copy? I hunt through AA every month but to no avail (where upon I lapse in uncontrollable sobbing).

Anyway, congrats on the storming mag, here's hoping for some answers.

**Russell Doano  
Gwent**

*Brunword should be perfectly adequate for your needs. It has a variety of fonts, and is specially designed to work with dot matrix printers.*

*As for Omnigraph, I'm afraid my software collection doesn't run to that. We did print a similar thing in Type-Ins recently, for solving quadratic equations. Probably nothing like what you had in mind. If anyone is familiar with such a maths program then get in touch.*

● **Eight-inch disk**

Please can you help? I wish to know where I can get hold of an eight-inch disk drive, interface for connecting to 6128, and O/S of suitable quality and also how much this lot will cost.

And now a note for any budding ornithologists out there. I have written a BASIC program which translates English names of British into their Latin equivalents. It contains over 500 different species and is fairly fast considering it is only in BASIC. It is disk-only, so if you want a copy, just send a blank disk and SAE to me and you will receive a copy pronto!

Just one more point... Why is it so difficult to get a letter printed? I have lost count of the amount of times I've written and this is probably my last desperate attempt before I finally give up. Great mag though!

**Lorne Murphy  
35 Longridge Ave  
Saltdean  
Brighton  
BN2 8LG**

*What on earth do you want an eight-inch disk drive for (apart from impressing the girlies)? No... I won't ask. If anybody has actually done such a thing then get in touch, please...*

*Similarly, if you're into birds, send a disk and stamped address envelope to Lorne.*

*What do you mean you never get your letters printed? You just did, didn't you?*

● **Mouse training**

For those who own a Kempston mouse and have been baffled by the instruction sheet (I wonder if they wrote the Amstrad manual?), I have managed to uncover the port addresses where the x and y co-ordinates are stored and may be accessed. Type:

**PRINT INP (&FBEE)\*638/255** to view the x co-ordinate of the mouse cursor  
**PRINT INP (&FBEF)\*398/255** to view the y co-ordinate of the mouse cursor  
**PRINT INP (&FAE7)** to view the state of either mouse button.

Note that only numbers in the range 0 to 255 can be stored at these locations, therefore both the x and y co-ordinates must be magnified to cover the entire screen. The port location &FAE7, used to detect the state of the mouse buttons, returns the value 124 when both buttons are pressed simultaneously, 125 when the left button is pressed, 126 when the right button is pressed, and 127 when neither button is pressed.

The following short listing demonstrates how the Kempston mouse may be implemented into your own programs:

```
1 ' DRAWING UTILITY for Kempston Mouse
2 ' Written by Matthew Prescott
3 ' 1990
10 MODE 1
20 BORDER 2
30 INK 0,0
40 INK 1,25
50 INK 2,2
60 INK 3,2
70 TAG
80 SYMBOL 255, &7F,&3F, &1F,&3F,&7F,&FB,&F1,&6B
90 DEF FN X=INP (&FBEE) *638/255
100 DEF FN Y=INP (&FBEF) *398/255
110 DEF FN Z=INP (&FAE7)
120 X=FN X
130 Y=FN Y
140 COSUB 310
```

```
150 IF FN Z(<)127 THEN 100
160 IF FN X(<)X OR FN Y(<)Y THEN 260
170 GOTO 150
180 COSUB 310
190 GOTO 240
200 X=FN X
210 Y=FN Y
220 IF FN Z(<)127 THEN 240 ELSE 120
230 Y=FN Y
240 DRAW X+10,Y+1,1,0
250 GOTO 200
260 COSUB 310
270 X=FN X
280 Y=FN Y
290 COSUB 310
300 GOTO 150
310 MOVE X,Y,2,1
320 PRINT CHR$ (255);
330 RETURN
```

Moving the mouse with neither button depressed will move the arrow cursor. Pressing and holding a button will cause the arrow to disappear and, when the mouse is moved, a line to be drawn. Beware that crossing the highlighted border whilst holding a button will prompt undesirable effects. You may move the mouse at any speed, the line will not break. This is a small section of an art package I have written for the Kempston mouse. I have written several other utilities, including a mouse-driven filing system. The best art package available for the Kempston mouse is the *Advanced OCP Art Studio*, which allows you to select the mouse from the input devices menu (see the manual). If you own a Kempston mouse (indeed, any mouse), this package is an essential.

**Matthew Prescott  
Australia**

*G'day Matt, and cheers for those hints, mate. Bonza. (Australian for thank you.)*

● **Interface for disk drive**

I recently bought an FD-1 Disk drive as my first disk drive for my 464. I bought it because it was selling for only £15. I am now stuck, I can't seem to find anywhere where I can buy the interface to connect the FD-1 to my computer. Could you please tell me how I could get hold of one.

If anybody out there is willing to sell me one at a reasonable price, I'll be most grateful.

**Duwayne Brooks  
77 Wydeville Manor Road  
Grove Park  
London SE12 0EP**

*The 464 disk upgrade is the DD-1. It comprises the interface and FD-1 disk drive. I'm sorry*

*to tell you that the interface is not available separately.*

*If you cannot get hold of the interface on its own (anyone who can help, please contact Duwayne at the above address), then you may have to resort to buying a complete DD-1 - the disk drive and interface combined. You could then quite happily use the FD-1 as a second drive.*

● **Disk drive drama**

I recently bought a bundle of seven Amstrad disks containing 50 games through an advert in AA. I want to erase some of the games to release disk space. However, when I catalogue the disks, the only file shown is **DISC.BAS - 1K System Files Exist**. Under CP/M DIRSYS list



the games files. I have tried to remove the system status and revert the files to directory status using the SET command from CP/M.

With the CP/M disk in the drive (I have a 6128) and typing SET at the A> prompt results in an **ERROR: NO OPTIONS SPECIFIED** message. With the games disk in the drive typing the command results in **SET?**

I cannot copy the SET.COM file to the games disk as it is not system format, or the the games disk back to the CP/M disk as they are system files only. I have tried help on side 3 of the operating system disks, and have been through the manual from front to back. Please help before I give up and go fishing!

**Steve Makin**  
Dover  
Kent

*You need to make the SET command wait until you've put the games disk into the drive before executing the command, Steve.*

*To do this you need to insert a B: between the command and the parameters. On a single-drive machine this will prompt you to insert another disk in the drive before commencing the operation.*

*Go into CPM and type:*

```
SET B:*. * [dir]
```

*You will be asked to put in another disk. Insert the games disk, and sit back while all your files are converted. All you need to do now is erase the ones you no longer require.*

### ● Power down

I have a major problem concerning my upgraded CPC464. A few years ago it was sent away to a repair company. Now I am having major problems getting any power to the computer.

The five volt DC input socket appears to be loose. A pencil wedged between the 5 volt plug and the monitor lead lets the power through, but one small bang on the table shifts the cable and the ON lamp goes off. I then have to spend several minutes fiddling with the pencil and the wire to get it working again.

As I thought the problem was in the computer, I took off the cover and examined the rear connections. On the bottom of the PCB one of the solder joints leading to the socket was cracked. I re-soldered it, and set the computer up again. Nothing happened, so I spent some more time at it. I have to use the pencil still.

I tested the plug by using an alternative

## ● Thank you very much

I would like to thank Chris Medway and Val Robinson for their suggested solutions to my problem, in issues 58 and 61. I now have my Amstrad and Printer working in beautiful unison and have produced many more pages to add to my increasing collection.

**John Tucker**  
Flitwick  
Bedfordshire

*Well said John.*

power supply. The computer would still not work, so I assume it is the socket that is faulty. Could you please tell me what is wrong with it, and what I can do to make the computer work properly?

**Adam Lloyd**  
Tunbridge Wells  
Kent

*It must be most unsatisfactory to have such a temperamental problem. As you say you've tested the circuit board for cracks, and cannot seem to fix the fault from there, may I suggest that the problem could lie in the socket itself.*

*Over the years of plugging and unplugging, it could be that the insides of the sockets have become tarnished, or that the springiness has gone, and so it's not making proper contact with the plug.*

*You seem to know one end of a soldering iron from the other, so I have no qualms in suggesting that you replace the power socket. Your local electronics supplier should have the necessary replacement part.*

### ● Computer fan

I am a young computer fan and I wonder if you possibly could help me. I own an Amstrad CPC6128 and recently my A drive broke down, and I am having a hard time getting it fixed at a reasonable price in Denmark.

Would it be possible for you to give me some information about companies doing repair work on the Amstrad computers in Great Britain.

**Kim Olsen**  
Hilleroed  
Denmark

*I rather think that the postage costs of sending your computer to the UK and back would offset any savings you may make on the repair. I'm doubtful that you'd make any great savings at any rate.*

*If it's a serious fault, it's likely that the drive may need to be replaced entirely. If that's the case, then CPC (no relation) will be able to supply you with one for £89.05. However, send your broken drive back to them, and they'll let you have it for £70.01.*

*You will need to fit the drive yourself, so if you're a ham-fisted oaf with the dexterity of an arthritic hippo, then I'd leave the soldering to somebody else.*

*Get in contact with the company before you send that international money order. The address is: CPC, 194-200 North Road, Preston, Lancashire PR1 1YP. Or why not run up an expensive international phone bill? Call them on 0772 555034.*

### ● Improve your memory

I have recently taken over a CPC664 system from someone who has upgraded to a PC. To bring the 664 up to date, I need to expand it a little.

I understand your reluctance to publish hardware projects but, since I am an electronics technician, I am sure that I could build, and debug before connection, any add-on devices at a far lower cost than commercial gear. A good example is the local price of \$159 for a 64K memory expansion. I can buy two 4464 memory chips for just \$4.50 each. Total cost, if I construct it myself, should be under twenty dollars. (My spare time at no extra cost.) Also there is ample room to fit inside the case. (instant 6128!)

Given the age of the CPC machines, I believe there may be many readers with some technical knowledge, who have expanded the memory to 6128 size or bigger.

**Colin Harvey**  
Elwood  
Victoria  
Australia 3184

*The reason we've steered clear of hardware projects in the past is not to do with the technical capabilities of our readers. It's the fact that if a mistake is made, it could result in lots of unhappy people with large repair bills. An error in a section like Type-Ins is annoying, but can easily be rectified in the next issue. Obviously the same cannot be said of a hardware project. However, we are considering introducing simple projects to see how it goes. If we can get together a failsafe system, then we may embark on some more ambitious projects. Anyway, for the time being, I have printed your address. Anybody who has built such a thing can get in contact with you.*

## ● What's the difference?

I would like to know what the difference is between the cartridge bit in a Plus machine and the GX4000 console?

**Chris Wheatherley**  
South Harrow  
Middlesex

*There's no difference at all. The cartridge games will run happily on all machines.*



# Ask Alex

**HI!**



Hello again fellow Amstrad users! I'm back to set you straight on all those niggly little problems that have you all lost and bewildered!

This month I'll be talking about pokes. What are they, what do they do, and how do you use them? I'll also be talking about how to type listings in.

Up 'til now, all my post has arrived courtesy of Adam - he's given me letters that are more suited to my page, rather than *Forum*, which was where they were addressed. Now I don't mind answering these second-hand letters, but I'd love to have some of my own!

So c'mon! I haven't had a letter addressed to me yet! So get them sent in, I'm so looking forward to receiving them!

*Alex*

## Key Confusion

Mr B Becket from Kettlethorpe in West Yorkshire has written in about not being able to find certain keys that appear in listings. I hope you don't mind little me answering your questions rather than Adam! Anyway, he says that he cannot find the keys marked f0, f1, f2 and so on, the ^ also remains elusive, as does the | key.

I think that part confusion has come from the differences in the keyboard between the CPC6128 and the CPC464. (Both Plus machines share the same layout as the CPC6128.)

For a start the keys on the 6128's numeric keypad are prefixed with an 'f'. On the 464 they just have the numbers. Whenever you read that one of the 'f' keys is used to access a function, use the number keys at the right hand side of the keyboard.

The '^' key looks more like ↑ on the Amstrad keyboard. The reason for the confusion is that different fonts display different symbols to represent the same character. Hmm, I think I'd better explain further...

AA use professional Desk Top Publishing

equipment to produce the magazine, which uses a variety of fonts. Fonts are simply typefaces. They define the style and shape of the letters that make up the words you read on page. (In case you're interested most of the writing in AA is printed in Glypha font.)

AA once used Courier font for listings. This is because it looks similar to a computer printout. Even though it was close, it wasn't perfect. The up arrow character was a prime example, looking very different from the one that the Amstrad displays on screen (or is on the keyboard.)

The AA team decided to incorporate a special new CPC font into their publishing equipment. The new font is an exact copy of the Amstrad's character set. So now any listings printed in AA appear precisely as they do on screen!

The | symbol actually looks a wee bit different on the keyboard. There's a little gap in the middle of it. I've no idea why they printed it that way - it's very confusing! Anyway it's obtained by pressing SHIFT and @.

Hope this sorts out your keyboard! If you have any other problems, get in touch!



## Is your Amstrad IBM-compatible?

Bruce Sandeman has written in with a question about IBM compatibility. "I would like to know if the 6128 is IBM compatible?" he asks.

I'm afraid the answer is a most definite No, Bruce. Sorry! IBM compatible means that the computer will run software, and connect to peripherals designed for the IBM PC computer. To do this they have to be virtually identical as the IBM - which is a boring old business machine. It's alright if you have a load of stuffy old accounts to sort out, but they're not nearly as much fun as a CPC, I can tell you!

The Amstrad is much more of an all round home machine. It's friendlier, you can learn to program it quite easily (it must be easy - I managed it!), and of course is miles more popular when it comes to games.

Bruce goes on to ask: "If it's not PC compatible, is it possible to connect a 3.5 inch disk



● No, the CPC is *not* IBM compatible. And a good thing too, we say!

drive, and save programs in IBM format?"

I think I know where you're coming from Bruce! I'll just bet that you use a PC at work, and want to carry on with your facts and figures at home. This time the answer is thank-

fully a big Yes! It's perfectly possible. You need to buy two items beforehand. A 3.5 inch disk drive (never!) and a utility to read and write to IBM format disks.

To make your shopping easier, I'm going to recommend one mail order firm who can supply both items to you. The PC transfer utility is unique to the supplier, but you'll be able to find 3.5 inch disk drives from various sources. Take a look through the adverts in AA.

The program is called 2 in 1, and in a review published in AA a few months ago came out tops as the best utility of its type. It costs £24.95. The disk drive costs £79.95 plus £3 carriage, so added together the total would be £106.90. Not too big a price to pay to keep you from working late at the office! Send your order to Microstyle, 212 Dudley Hill Road, Bradford, W Yorks BD2 3DF. You can ring them first on 0274 636652.





# Typing in programs...

**N**ow you've got your shiny new computer, it might not be a bad idea to learn how to use it! Typing in printed programs is in fact quite easy...

A program is simply a list of instructions that tells your computer what to do. Because of this, programs are often referred to as listings. The computer doesn't understand these directly, though - it works in machine code, a horribly complicated language made up from numbers. To make things easier for the rest of us, easier 'languages' have been developed that both humans and computers can understand so that you and I can learn to put programs into the computer.

The Amstrad has a built-in language called BASIC. This stands for Beginners' All-purpose Symbolic Instruction Code. At the start of every line there's a number. This tells you whereabouts in the program that particular line sits. So, for example, line 10 goes before line 20. This means that if you want to insert a line in between two existing ones, you'd simply choose a line number in between. With the above example, adding line 15 would work.

To type in listings you don't actually have to understand what the instructions do! But you do have to make sure that they are typed in *exactly*, otherwise the computer won't be able to understand the instructions that you're giving it.

If you do make a mistake you can move the cursor (the square block where the letters appear as you type them) back and forth through the line with the cursor keys - those four keys with arrows on them. Note that you can still see the letters 'through' the cursor. Mistakes can 'rubbed out' using the CLR and DEL keys: CLR gets rid of the character directly below the cursor; DEL erases the character to the left.

You have to tell the computer when you've finished each line. To do this you press the RETURN or ENTER key. The computer will check to see whether you've put a line number at the beginning. If you have, it will be put into the correct place in the listing. If not the command will be acted upon immediately.

Apart from learning how to type your programs in, you'll need to know a few keywords that are connected with typing in listings. These don't have line numbers, because you want the computer to act straight away:

- When you've finished entering the listing, you may like to see what the program looks like. To do this just type LIST (followed by RETURN, remember!). Your program will appear on the screen, with the lines in their proper sequence.

- As I said before, listings need to be typed in accurately to work. The teeniest mistake will result in an error. If you spot a mistake in your listing you'll need to rectify it before it'll work. You could re-type the line all over again, but there is a much easier way. You can edit your work with the EDIT command. If the error is in

line 30 then just type EDIT 30 (don't forget that RETURN!) The troublesome line will appear with the cursor within it. Use the cursor keys and CLR and DEL to correct the line. Press RETURN when you're done.

- It's all very well having your little program-ette typed in, but it's not much use unless you know how get the thing started! RUN starts the program.

- When you've got bored of the listing pressing ESC twice quits the current listing.

## Type-ins

If you don't understand BASIC, you won't be able to make your own programs! Instead you'll need to get your listings from somewhere else. Pages like Type-Ins in Amstrad Action are ideal. These are programs that others have submitted to the magazine for publication.

It's probably a good idea to start with the smaller listings. The bigger ones can take hours to type in, and are prone to be full of mistakes! (Due to your typing by the way, not

because the magazine's at fault!)

The listings in Type-Ins are presented in such a way to make them even easier to enter, with less possibility of mistakes. The first thing you'll notice is that before each line there's a strange code in brackets. DON'T type this in! This is a special reference number to help you make sure that they're typed in correctly. To use them you'll need a copy of Type-writer - a special AA program that is reprinted every now and again.

Don't worry If you don't have Type-writer. Just ignore those codes. The other thing you'll notice is all the dots. You won't find them on your keyboard, so quit looking! These are used to represent spaces. Every time you come across a dot, replace it with a space instead (but don't confuse them with full stops!). I expect that you're wondering why? Well it's very difficult to tell exactly how many spaces there are when there's more than one in a row. The dots show you exactly how many spaces there should be. See - we are trying to make it easier for you after all!

## Poking problems?

One of the letters Adam passed on to me was from Marie Butler on the subject of pokes. When I spoke to him on the phone he said that it was an ideal subject for me to tackle. I explained that I didn't really understand them myself! So he said well, you'd better find out then hadn't you!

Well, I've done my research, read a bit of cheat mode, and asked his nibs (ie Adam) for advice more than once. So here goes...

A poke is one of those words with double meanings. The most general term is to describe a way of altering the code of a game to allow you to cheat! The original meaning is different (and a sight more technical!). I'll try and put it as painlessly as possible, but to understand fully, you're going to have to listen to some fairly hefty explanations!

The computers memory is made up of several thousand locations. Each individual location is called a 'byte', and quite simply can hold a number. These numbers mean more to the computer than you or me! It interprets each number as an instruction, telling it to perform some action in machine code.

A 'poke' is a BASIC command that tells the computer to change the number held in any one of those bytes. There are over 65,000 of these bytes in your CPC, each can store a number in the range 0 - 255.

Any program written in machine code is simply a long list of numbers held in those bytes. Those numbers represent various instructions. By poking an individual byte, you change a part of the machine code program.

Take a typical game. Somewhere in there will be an instruction that decreases the number of lives you have, etc. If you're able change that instruction, so that instead of decreasing the amount of lives it does nothing, then you have managed to cheat it! Whenever you die in the game, instead of decreasing the number of lives you have, they will remain the same, so you'll be able to play for ever and ever. Hurrah!

Finding which byte of memory to poke can be difficult. Most games are protected, so it's not easy to be able to put your 'poke' in. You need to understand machine code too, and recognise what the computer's doing to enable you to change the vital instructions. Also some games need several pokes to make the changes. If you want infinite bombs, infinite bullets and infinite lives etcetra, then you'll have to use at least one poke for each.

So most pokes take the form of listings, which poke several areas of memory. Some are in machine code, so that they can get round a game's protection and do their dirty work without being detected!

That's why the term poke often means a blinkin' great listing! To put these listings into the machine you simply type them in as a basic program. See the item about that elsewhere on this page...

Uncle Phil's *Cheat Mode* section deals in-depth with poking. To use most of the listings, simply type them in and RUN them. The game you wish to cheat should be in the tape or disk drive. The game will load, the memory poked, and you'll be able to cheat away!



# SOCCERSEER

(The Friendly Pools Predictor)

- ★ Predicts Draws, Homes, and Aways
- ★ One Key Press Operations  
- No team names to type in -  
Point Arrow and Select!!!
- ★ Enter Scores -  
See New Tables Immediately
- ★ Automatic Promotion /  
Relegation at Season End

- ★ Flexible Division Sizes  
allows for F.A. Changes
- ★ Supports All English and  
Scottish Leagues
- ★ Leagues Updated Weekends  
for Monday Dispatch!

**FREE Popular Newspaper Plan Checking Program  
with every SoccerSeer Ordered**

**Available on disc for 6128 at £14.50 inc. p&p.  
SEERSOFT, 109 North Road, Audenshaw, Manchester M34 5RJ**

£ £ £ £

**BANK BALANCER V1.03**

£ £ £ £

Software to manage any type of Home Accounts. (464/664/6128) Please state

Menu driven from 12 menus with up to 10 choices each (f0. to f9.)  
Capable of storing 7000 transactions on one disc  
Each entry has No., Date, Description, Code, Debit/Credit, Balance.  
Coding facility allows thousands of codes for each account category.  
Automatic balance calculation and triggering of standing orders.  
Standing order definitions for 1 week, 2 week, 4 week, 1 month, 4 month, 1 year  
Global Search and display facility. eg. Find and display all CHEQUES etc.  
Password protection of stored data. (Up to 20 characters long).  
User definable colours and key definitions.  
Autorun facility will load and display any file of your choice on start up.  
Browse through transactions page by page.  
Print page, section, file or control codes to Epson compatible printer.  
Uses two disc drives if required.  
Disc management from within program. Erase, Cat, User, Drive etc.  
Status screen shows Date, Last date, Balance, Drive, Title, Edit No. etc.  
File handling includes Edit, Insert, Remove, Search, Exchange, Browse.  
Change amount, preset balance, running totals for all standing orders.  
Custom alarm system traps all illogical inputs and user mistakes.  
Example files on disc, comes complete with full user manual.  
Telephone helpline available if needed.

CHEQUE/PO payable to:  
**OSPREY SOFTWARE**  
Allow 28 days delivery

DISCOUNT FOR BULK  
TRADE ORDERS WELCOME  
TEL: (0742) 696863

£16.50 from...  
Osprey Software  
11 Medlock Road,  
Sheffield, S13 9AY

# ★ FREE SOFTWARE ★

## 3 1/2" DUAL DISC DRIVE £79.95

**BEST PRICE 6128 PLUS**

**800K STORAGE PER DISC PLUS £3 CARRIAGE  
INCLUDES MAXIDOS AND PROCOPY - FREE!**

We offer you:-

The **MOST RELIABLE** 3.5" disc drive available (TEAC); the **MOST COMPACT** drive of any size (4" x 6.75" x 1"); the **BEST PRICE** by far of any 3.5" drive; easily the **BEST FREE SOFTWARE** (the major utilities, Maxidos and Procopy, were until recently, sold at £13.75 each!); **FORMAT TO 800K** on each disc (ROMDOS, RAMDOS or RODOS is needed for this); **UNIQUE SIDE SWITCH** allows you to use the drive as a **STANDARD B DRIVE**, formatting to 178K free on each side of the disc. Everything that can be done with an FD1 can be done with our 3.5" drive. Now you can choose **NORMAL OR 'BIG DISC'** mode.

Supplied ready to plug in and use. Please state 464, 664, 6128 or 6128 PLUS.

### **BONZO SUPER MEDDLER..... £13.75**

now includes the **BONZO HACKPACK - free!** The most comprehensive tape to disc utility. Supplied on disc with a huge database of verified transfers.

Produces stand-alone transfers.

"A real alternative to a Multiface" - Amstrad Action

"The best tape to disc transfer utility available" - WACCI

### **BONZO BLITZ .....£13.75**

now includes **BONZO'S DOODAH and 4 adventure games - free!**

Tape to disc transfers. Deals with all forms of Speedlock. Works on all CPCs. Huge database of verified transfers.

### **BONZO's BIGBATCH.....£10.00**

Fast, flexible **DATABASE**, superb **FOOTBALL POOLS PREDICTOR** plus a user-friendly, memory saving **SCREEN & SPRITE DESIGNER**.

### **BONZO's FLASHPACK .....£10.00**

Simply too much to list. Please send for details. "Best all round basic extension program" WACCI

## **MAXIDOS £13.75**

**THE MOST COMPREHENSIVE & EFFECTIVE GENERAL DISC  
UTILITY AVAILABLE FOR THE CPC**

fully compatible with **RAMDOS, ROMDOS, AMSDOS** and **CPM** formats!  
**COPY** files or discs at lightning speed; **VERIFY** discs; **RESURRECT** erased files; **FAST FORMAT** in Amsdos/Ramdos/Romdos; **IDENTIFY** disc format; **CAT** shows *all* files (inc. erased ones) with optional status/address/length/etc details; alter **USER AREAS**, make system (invisible) or read only, **DISPLAY** or **PRINT** files...**AND MUCH MORE!** **BEST SECTOR EDITOR EVER** for the CPC. All standard editing facilities **PLUS:** File mapping - lists locations of files on disc to screen or printer, auto step by step movement through a file, string and byte search through file or whole disc. Compatible with all above formats! **FILE ARCHIVER** Save disc space by backing up discs to tape: variable baud rates (1000-3000). Very easy to use. **SPEED UP YOUR DISCS!** The unique **OPTIMIZE** physically re-arranges your 'crowded' discs, making them load **up to 50% faster.**

"I can heartily recommend this product" *Richard Sergeant - CPC USER*

**NOW SUPPLIED WITH CPC PROCOPY .....FREE !!!**

**PLEASE  
ORDER  
EARLY  
FOR  
CHRISTMAS**

### **TIPS & THINGS**

- PROTEXT and RODOS are incompatible
- When buying ROMDOS, the RAMDOS disc is also supplied.
- RAMDOS is needed for CPM use.
- PROCOPY is a disc to disc copying utility.
- HELPLINE: customers and non-customers are welcome to our advice and assistance. We don't have all the answers but you're welcome to any that we have.

### **PC-CPC-PC FILE TRANSFER**

Moonstone's 2 IN 1, the Rolls Royce of PC/CPC file transfer utilities, not only allows the transfer of files between the CPC and PC by copying to and reading from PC discs but it also allows the same data discs to be used in both machines. Format, copy, cat, etc. PC discs on your CPC. Full range of utilities - fully menu driven.

**now only £24.95**

"Quite simply, it knocks the competition into a cocked waste paper basket".  
Amstrad Action Oct 90'.

## **OTHER ITEMS**

- 64k DKtronics RAM PACK.....38.99
- FD1 DISC DRIVE (See below) .....£64.95
- RAMDOS (disc) .....24.95
- ROMDOS (rom) .....29.95
- 3.5" DISCS (branded bulk) 10 for 7.50  
30 for 20.00
- 3" DISCS (Amsoft).....10 for 20.00
- 3.5" DISC BOX lockable, holds 40...7.00
- PRINTER LEAD (CPC or PLUS) 6' ...8.00

Please add £3 p&p to disc drives  
FD1 - state 464, 664, 6128 or 6128 PLUS

## **NEW 32k RAMROM - £13.95!!**

The latest addition to our range is a little gem. It is 32k of RAM which can be loaded with 1 or 2 (yes two!) ROM programs. After which it behaves exactly like 1 or 2 ROMs. It plugs onto the computer so a romboard isn't needed. You can select a rom slot for each 16k bank or choose to have both banks on the same slot switching between them at will. Complete with through connector and type-in software, it is now available for an amazing £13.95. Send s.a.e. for fuller details or a cheque to get yours now.

### **UPGRADE YOUR 64K RAM TO 256K ONLY £29**

Now your 64k Ram can contain a massive 256k. Just send us your pack with a cheque for £29 and in a few days we will return it to you with a full 256k inside. Your existing software will operate the increased memory.

## **EPROM PROGRAMMER only £30 inc. p&p**

Transfer your favourite programs (Basic/Machine code) onto rom. Programs 8k, 16k; 21v and 12<sup>1</sup>/<sub>2</sub>v eproms. Powerful but easy to use software, rom to rom copy, editing, verification, single byte or block programming. **Blank 16K eproms ... £3.50 each or 5 for £15.00**

### **FREE PLUG**

**UNITED AMSTRAD USER GROUP.** A genuine CPC user group, run by a members' committee, arranges members' discounts, provides multi-expertise helplines, produces a bi-monthly fanzine (THE CPC USER), large PD library on disc and tape. Contact: Tony Baker, 26 Uplands Close, Fareham, Hants., PO16 7JY. Tel: 0329 234291.

# MICROSTYLE

**DEPT. AA, 212 DUDLEY HILL ROAD,  
BRADFORD, W. YORKS BD2 3DF.  
Tel: 0274 636652 (after 2pm).**

Prices include VAT and carriage unless otherwise stated.



# CHEAT MODE BOOK

READ THE SMALL PRINT!

Important: Do you have any of the following games...?

You've seen the covermount (AA56), you've read the blurb - now buy the book! *Cheat Mode II - The Revenge is here...*

**A**ll you old timers out there *must* remember *Cheat Mode 1*, the collected hinting, tipping and poking wisdom of *Amstrad Action's* first sixteen issues. This magnificent 92-page epic was snapped up in its thousands by eager AA readers looking for a way to take the sting out of their fave games...

Well you ain't seen nuthin' yet. *Cheat Mode II* takes the best cheats from the last three years of *Cheat Mode* and crams it into 130 pages of absolutely essential info.

And as if that wasn't enough, we've gathered together 150 previously unpublished listings from such poking giants as Phil Howard, Mike Wong and Graham Smith.

Mind you, typing in all those listings is OK for practiced BASIC-bashers, but can be fraught for the rest of us... which is why *Cheat Mode II* is also available with cassettes containing all those pokes!

*Cheat Mode II* costs £9.99 on its own, and £11.99 with the two cassettes. Postage and packing in both cases is £1.45. All you have to do is fill in the order form below and send it off to the address printed - and you'll become the proud owner of the most important new work since... since... well, since *Amstrad Action* itself, dammit!



- 1942 • 1943 • 2008 • 3D Starfighter • 3D Starstrike • 720 Degrees • Academy • Activator • Advanced Pinball Simulator • Afterburner • Airwolf • Airwolf II • Alien Highway • Aliens • Amaurote • Anarchy • Android II • Angleball • Arctic Fox • Arkanoid • Armageddon Man • Army Moves • Asphalt • Asterix • ATF • Auf Wiedersehen Monty • Avenger • Back to Reality • Bad Dudes vs Dragon Ninja • Ball Breaker • Ballcrazy • Barbarian • Barbarian II • Bards Tale • Basil the Great Mouse Detective • Batman • Battlefield Germany • Batty • Bedlam • Beyond the Ice Palace • Bigfoot • Biggles • Bionic Commando • Biospheres • Blood Valley • BMX Simulator • BMX Simulator II • Bobsleigh • Bombscare • Boscorian • Boulderdash • Boy Racer • Brainache • Bravestarr • Breakthru • Bubble Bobble • Cauldron II • Caves of Doom • Challenge of the Gobots • Championship Sprint • Cholo • Chronos • Chuckie Egg • Classic Muncher • Climb-It • Cobra • Cobra Force • Combat Lynx • Continental Circus • Contraption • Cop-Out • Crazy Cars • Crazy Cars II • Critical Mass • Curse of Sherwood • Cybernoid • Cybernoid II • Dan Dare • Dark Side • Death Wish III • Deep Strike • Desolator • Dizzy • Dominator • Doomdark's Revenge • Doomsday Blues • Doors of Doom • Dr Destructo • Dragon Ninja • Dragon's Lair • Dragon's Lair II • Driller • Druid • Druid III • Duet • Dun Darach • Dynamic Duo • Eagle's Nest • Eilodon • Elite • Empire! • Enduro Racer • Enlightenment • Equinox • Exolon • Fairlight • Fast Food • Fernandez Must Die • Fued • Firelord • Firetrap • Fly Spy • Flying Shark • Football Manager • Forgotten Worlds • Four Smash Hits • Freddy Hardest • Frost Byte • Galactic Plague • Galletron • Game Over • Game Over II • Gauntlet • Gauntlet II • Gemini Wing • Get Dexter II • Ghost Hunters • Ghosts 'n' Goblins • GI Hero • Glider Rider • Go Loader • Golden Talisman • Gothik • Grand Prix Rally II • Grand Prix Simulator • Green Beret • Gryzor • Gunship • Gunstar • Hacker II • Harrier Attack! • Head over Heels • Heartland • Heavy on the Magick • Herbert's Dummy Run • Heroes of the Lance • Highway Encounter • Hive • How to be a Complete... • Hunchback • Hunchback II • Hunt • Hydrofool • Icon Jon • Ikari Warriors • Impact • Impossaball • Incredible Shrinking Sphere • Indiana Jones and the Temple of Doom • Infiltrator • Inheritance • Inside Outing • Into the Eagle's Nest • Jack the Nipper • Jack the Nipper II • Jackle and Wide • Joe Blade • Joe Blade II • Karnov • Kat Trap • Killapepe • Killer Gorilla • Knight Tyme • Krakout • Last Ninja II • Leaderboard • Licence to Kill • Lightforce • Little Computer People • Live and Let Die • Living Daylights • Mad Max • Manic Miner • Mask • Masters of the Universe • Match Point • Mazie • Metal Army • Metaplex • Miami Vice • Mickey Mouse • Mikie • Mission Genocide • Mission Jupiter • Monty on the Run • Moon Cresta • Moonbuggy • Motor Massacre • Moto • Moving Target • Mr Freeze • Mutant Monty • Navy Moves • Nosteratu • Oh Mummy • On the Run • Operation Gunship • Operation Wolf • Outrun • Palitron • Paperboy • Parabola • Pipeline • Platoon • Predator • Prohibition • Pyramyda • Questor • R-Type • Radius • Radzone • Rambo • Ramparts • Ranarama • Rasputin • Rasterscan • Rebelstar • Red Heat • Red LED • Red October • Reflex Power • Renegade • Renegade III • Rick Dangerous • Road Blasters • Road Runner • Robocop • Rocky Horror Show • Roland in the Caves • Roland in Time • Rygar • Saboteur II • Sacred Armour of Antiriad • SAS Combat Simulator • Savage • Scooby Doo • Scuba Kidz • SDI • Sentinel • Shanghai Karate • Shark Tape • Shockway Rider • Short Circuit • Silkworm • Skweek • Solomon's Key • Soul of a Robot • Space Harrier • Space Hawks • Speed King • Spellbound • Spiky Harold • Spindizzy • Spindrome • Split Personalities • Spooked • Spy Hunter • Spy vs Spy • Star Wars • Starfox • Starglider • Stormbringer • Stormlord • Strangeloop Plus • Streethawk • Strider • Strike Force Cobra • Super Hang-On • Super Hero • Super Robin Hood • Super Stuntman • Superstest Day 1 • Sweevo's World • Sword Slayer • Swords and Sorcery • Tanium • Tankbusters • Target Renegade • Tempest • Tenth Frame • Terra Cognita • Thanatos • The Duct • The Fear • The Fourth Protocol • The Real Ghostbusters • The Train • The Trap Door • They Stole a Million • Thing Bounces Back • Thrust • Thrust II • Thunderbirds • Thunderblade • Thunderscats • Total Eclipse • Tour de Force • Trail Blazer • Trantor • Trap • Treasure Island Dizzy • Triaxos • Turbo Esprit • Typhoon • Uridium • Vampire • Venom • Victory Road • Vindicator • Vixen • Voodoo Rage • WEC le Mans • Who Dares Wins • Who Dares Wins II • Wizard's Lair • Wizball • Xcel • Xor • Xybots • Yabbadabadoo • Yogi Bear • Zarkon • Zoids • Zub • Zynaps

*Yup, you've guessed. Every single one of these games gets the Cheat Mode treatment in Cheat Mode II: The Revenge. Unbelievable, isn't it!*

*Can you afford to be without it?*

## ORDER FORM

Yes please! Send the following right away:  
(Tick the appropriate box)

Copy/copies of the indescribably spiffing *Cheat Mode II* at £9.99 each

(Remember to add £1.45 for p & p)

Copy/copies of the even more fabulous *Cheat Mode II* plus tapes at £11.99 each

(You haven't forgotten the £1.45 p & p, have you?)

Name .....

Address .....

.....

.....

Telephone number .....

I enclose a cheque/postal order for .....

Made payable to "Future Publishing Limited"

I wish to pay by Access/Visa. Card number .....

Expiry date .....

Signed .....

(Please allow 28 days for order processing and delivery)

Send your payment to-

Amstrad Action Cheat Mode Book Offer

Freepost

Somerton

Somerset

TA11 7BR

### TELEPHONE HOTLINE

If you simply can't wait for the post, you can order your copy of *Cheat Mode II* by credit card. Simply phone 0458 74011...





# The Amazing Amstrad Action Kastle Kombe Karting Day

What do you get when you combine six Amstrad Action Fifth Birthday Compo winners, the staff of Amstrad Action, six race-tuned, turbocharged, rubber-burning 900bhp monster go-karts (er, a bit of journalistic licence here) and a large cake?

Absolute blinkin' mayhem, that's what...



Typically, it was the coldest day of the year so far. The wind whistled from Siberia across the Cotswold Hills straight into the bones of the assembled competition winners and Amstrad Action bods gathered at the Castle Combe go-karting circuit.

Everybody was kitted out in Mansell-style overalls, and as we made our way over to the track an awed silence fell over all the participants. There they were; finely-tuned, thoroughbred racing machines gleaming with speed, grace and power. Glittering metal symbols of man's determination to push himself to his very limits.

One by one the beasts were fired into life, and there they sat, throbbing purposefully, perhaps even angrily (except one, which seemed to have a dicky spark-plug). We could hardly wait! Then we watched amazed as water was sprayed onto a section of the circuit just before the most wicked corner. Water! What were they trying to do

to us? A marshal explained. "The water just makes things a little more interesting. You'll need skill and ability to negotiate that part." In one fell swoop that wiped out the Amstrad Action crew.

On to the first practice laps. These would have been a few sensible, acclimatising circuits which would give everyone a feel for the vehicles. Would have been. But unfortunately James 'Senna' Leach was one of the people to go round first. Regular readers will know that James and karting are old acquaintances. As all the other drivers gently motored around, James belted along like a madman, forcing everyone else out of the way. His thin, reedy voice could be heard bellowing triumphantly above the combined engine noise and tyre squeals, as he threw his kart around with all this finesse, skill and daring of a drunken Liverpoolian navy wrestling with a runaway earthmover...

Rod and Adam also got their turn at a warm-up session; Rod (I've driven a Lotus) Lawton kept strictly to the scientifically devised racing line he had worked out in the car on the way to the circuit that morning. Adam,

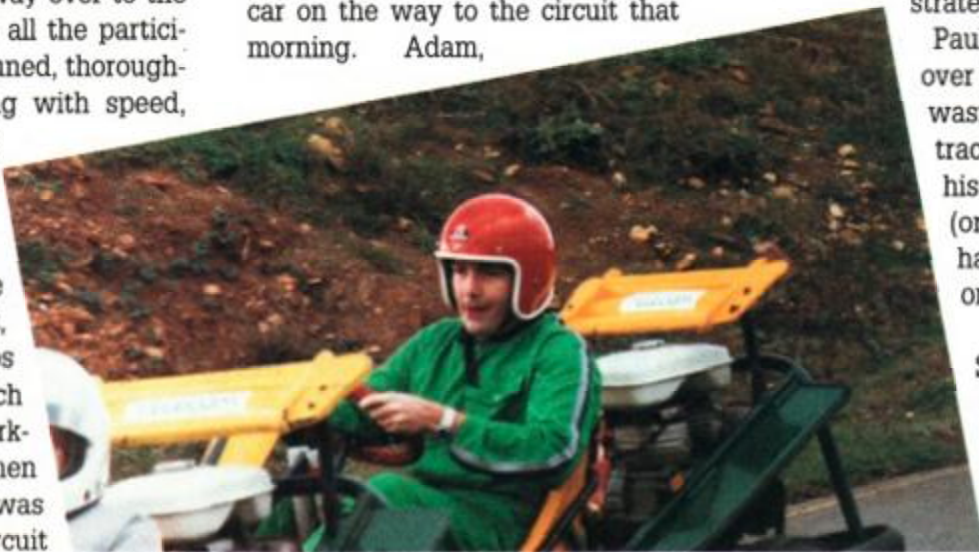

James glimpsed briefly in an uncharacteristic second place (he was usually in a ditch or sliding down the track on his head).



however, travelled round in a manner that could only belong to someone who has very little tynig him to this mortal earth.

Representing the arty side of the magazine were Paul (I'm new here you know) Tudor and Jacqui (So am I) Spanton. Jacqui wasn't, i must be said, as reckless a many of the other budding champi on



Rod demonstrates his overriding sense of fair play by punting Adam off in the final bend...

there. She waited for everyone else to pile off on the corners and then scooted past. It was to prove a remarkably successful strategy.

Paul (INHYK) Tudor was totally bowled over by the event, and spent all the time he wasn't racing standing at the side of the track, shouting and waving his arms above his head in time-honoured Grand Prix style (or so he assured us, although no-one else had ever seen this occur at a Grand Prix or anywhere else).

And finally, the AA Photographer Stuart Baynes. We persuaded him into kart with the help of a pair of tyre levers and a tub of axle grease (he's about seven feet tall and parks trucks with his bare hands). Stuart was quite simply, as mad as an egg-curd. He seemed determined to ram c







everyone else on the track, as well as demolishing all the road-side crash-barriers and any spectators foolish enough to stand within thirty yards of the track.

The AA team hurled themselves into the warming-up laps with such vigour that they were totally exhausted by the time the real racing started. In contrast, the compo winners carefully bided their time...



● Would you tangle with this man?

## THE CUTTING OF THE CAKE

Once the racing was over, anybody who could still walk was summoned to the ceremonial cake-cutting. An reverent hush descended. Adam was issued with a tiny fruit knife which Rod had con-



● Adam digs in at the ceremonial cake-cutting.

cealed about his person on the way to the circuit. The cake was pierced; Adam sawed away at it for several minutes (the icing was about a foot

thick - yum!) but eventually he managed to tear off enough to give everybody a piece. Standing in a freezing field, covered with oil and bruises, eating a strange console-shaped birthday cake, we all declared the day an unqualified success.

● Rod managed a small crumb.



## THE WINNERS

1 Philip Haddigan had travelled down from Scotland for the occasion. He started off being calm, unflappable and gentlemanly. This was perhaps not the correct attitude to take when dealing with manic humanoids such as James or Stuart. Philip soon repeatedly formed close attachments with the crash barriers around the track. In short, people were taking advantage of his good nature by slamming him into piles of old car tyres. Quite understandably, he was not best pleased. As the day wore on, he became more and more competitive until he was rushing round the circuit with his eyes popping out and his teeth set in a ferocious grimace. Never have we seen a man undergo such a complete transformation.

2 Mrs Hawes (Leslie to her friends), had only popped across from Worton near Devizes. Years of safe motoring had ingrained into her a road-sense that made her the most considerate, capable and reliable driver on the track. Which unfortunately was a set of characteristics entirely opposite to those needed. Indeed, she was the only person to actually pull across to let people overtake her. While this style of driving is admirable on the highways and byways of Britain, it doesn't really ensure your chances of success on a slippery kart track. Leslie remained resolutely cheerful throughout the day, and kept driving solidly around the circuit while all the other tear-aways were thumping into each other, or disappearing off the track completely.

3 And then there was Richard Wildey. Another mild-mannered lad, he was transformed into a vicious, win-at-all-costs mad-



man on the circuit. He frightened all of us, even Stuart, who was almost as bad. Richard rammed off everybody he could. James in particular was foolish enough to enter into a duel with him and ended up two fields away, upside down, blubbing like a baby.

4 Simon Woodley. One of Dorset's finest. Well, we weren't sure what he was thinking for most of the time. He appeared to be sizing up the odds and calculating the line of least resistance to take around the course. And what was worse, he appeared to be making copious mental notes about each of his fellow competitors. This might explain why the only time we saw him laugh was when Rod was on the circuit.

5 Richard Dobson, from Bicknacre in Essex appeared to have such a cheery, carefree nature that we were sure it couldn't last. He took to karting like a duck to water, though. He raced around so quickly that the rest of us were looking for the rails which surely had to

be driving on. As the day wore on, Richard lost none of his good humour. He also seemed impervious to

the Arctic winds which knifed across the circuit.

6 Perhaps most striking competitor was Gareth 'Silver Bullet' Floodgate. He adopted a laid-back approach to karting. So laid back, in fact, that he was only three degrees off the horizontal. The reasons for this were two-fold; firstly his drag co-efficient was reduced to 0.28 Cd, and secondly it was the only way his feet could reach the pedals. His driving certainly didn't suffer, however. And, more importantly, he was the only driver not to suffer a bruised back afterwards. This was due to the large number of cushions he had strategically placed between him and the seat.

The Silver Bullet was the winner of the final, compo-winners-only, race. Congratulations, Gareth! Braintree must have celebrated long into the night.



# DATEL ELECTRONICS

**dk'tronics**

## 64K AND 256K MEMORY EXPANSION

DATEL ELECTRONICS 256K MEMORY

DATEL ELECTRONICS 64K MEMORY

DATEL ELECTRONICS 256K MEMORY

- Simple plug in memory expansion gives instant extra memory.
- Features bank switching software for easy use by the programmer or for use as a data storage area.
- The software also features some extra BASIC commands.
- 64K unit expands 464 to 128K. The 256K unit takes your 6128 to 320K!!
- 64K unit brings 464 up to CPC 6128 memory configuration making a much larger software base available. Will work straight off with many programs designed for this unit (including OCP Art Studio - see Ad.).
- Ideal for use with the CPM 2.2 etc.
- Bank switching done automatically by software (cassette 464 - disk 6128).

**ONLY £49.99 64K FOR 464**  
**ONLY £99.99**  
**256K FOR 464 OR 6128 (PLEASE STATE)**

**THE RAM MUSIC MACHINE IS PROBABLY  
THE MOST EXCITING MUSIC ADD-ON  
AVAILABLE FOR ANY COMPUTER**



## music machine

- It's an echo chamber & digital delay line. Create some very interesting effects.
- It's a two voice music/sound synth.
- The Music Machine can also be used as a drum machine - eight drum sounds are already provided for you, but you can easily produce more of your own.
- The extremely powerful software allows you to compose tunes from individual bars of music. You can edit your creations on screen & Save/Load sounds, instruments & rhythms.
- Fully MIDI compatible. The Ram Music Machine supports full MIDI In, MIDI Out &

MIDI Thru.

- Output through your Hi-Fi or Headphones. Comes complete with microphone.
- Use a full size MIDI keyboard to play the Music Machine.
- Sounds produced by the Music Machine can be mixed with a MIDI synthesiser's own sounds.
- On screen Sound Editor can produce MIDI data from your own compositions.
- Various sampled sounds are provided in order to get you going.
- No other product can offer so much in one unit - it's the TOTAL SOLUTION!!

**ONLY £49.99**  
**FOR THE BEST MUSIC ADD-ON AVAILABLE FOR THE AMSTRAD**

## AMDRUM



- Now you can turn your Amstrad into a real Digital Drum Machine.
- AmDrum from Cheetah Marketing is a superb plug in device that produces "real" drum sounds via its unique digital system.
- On screen menu driven drum kit makes composing drum sounds easy for anyone to do!
- Just plug the output into your Hi-Fi, cassette player, etc. and that's it - your Amstrad is a drum kit!!
- Comes complete with DrumKit Sound plus extra DrumKit and Kit Editor Program (worth £9.99) absolutely FREE!!

**ONLY £14.99**

## SPEECH SYNTHESISER & STEREO SOUND BOOSTER

- This easy to use Speech Synthesiser includes a powerful Stereo Amplifier and two pod speakers which are an enormous improvement on the sound supplied by the internal mono speaker.
- Speech output is monorial but directed to both speakers. Booster gives stereo to computer internal sound output.
- Using the SPO/256 Speech Chip the unit has almost infinite vocabulary.
- Text to speech software is provided in ROM to make speech output simplicity itself.
- Voicing is transparent to the user and the computer can carry on with other program tasks as necessary.



**ONLY £29.99**  
**464 OR 6128 (Please state which)**

**dk'tronics**

## LIGHTPEN/GRAPHICS SYSTEM



- Complete Lightpen and graphics system lets you create a whole range of effects on screen.
- It can magnify, shrink, colour fill and create circles, rectangles, lines and curves.
- Pictures can be edited at pixel level using a scratch pad which is magnified to a full screen.
- Picture storage and retrieval, and a pen calibration feature.
- Printer dump utilities for Epson/Amstrad printers supplied (on cassette).
- Complete package - no more to buy.

**ONLY £14.99 CASSETTE**  
**OR £24.99 WITH SOFTWARE ON ROM - NOTHING TO LOAD 464 OR 6128 (Please state which)**



# NOW A TOTAL MOUSE/GRAPHICS PACKAGE FOR YOUR AMSTRAD AT A TRULY UNBEATABLE PRICE!!



TAPE OR DISK FOR 464 OR 6128 (PLEASE STATE WHICH REQUIRED) N.B. 464 NEEDS DK'TRONICS 64K RAM PACK

## Genius Mouse

COMPLETE WITH

**OCP**  
ADVANCED ART STUDIO



- Genius Mouse is a high resolution two button mouse featuring optical counting, teflon guides, microswitches, rubber coated ball and high quality interface.
- When combined with OCP Advanced Art Studio this graphics package is quite simply the best system available. The features are unmatched...
- Create an image - shrink it, expand it, move it, rotate it, copy it, colour it, etc., etc.
- Spray patterns or shades, make elastic lines - stretch and manipulate shapes.
- Zoom in to add detail in fine mode. ● Full cut and paste facilities plus excellent printer support.
- Pulldown/Icon driven menus for ease of use. ● Mouse operation, plus joystick and keyboard control.
- 16 pens, 8 sprays, 16 brushes - so flexible anyone can create superb graphics easily.

### COMPLETE WITH MOUSE INTERFACE



- The Genius Mouse Graphics System comes complete with the special Mouse Interface to allow super smooth control.
- Attractively styled to match your 464 or 6128 design and colour.
- Simply plugs into Expansion/Joystick port.

**ONLY £49.99**  
TOTAL PACKAGE  
INCLUDES GENIUS MOUSE,  
INTERFACE, OCP ADVANCED ART  
STUDIO PLUS FREE MOUSE MAT  
AND HOLDER



**FREE!**  
MOUSE MAT AND  
MOUSE HOLDER  
(WORTH £12.99)  
WITH EACH PACKAGE

## NEW LC 200 COLOUR PRINTER PACKAGE



**NOW YOU CAN PRINT OUT YOUR PICTURES IN FULL COLOUR!**

- The Star LC200 Colour Printer not only prints in Near Letter Quality for your regular jobs but also prints out your pictures from Art Studio, etc., in genuine colour!
- LC200 is a full Centronics printer so it works with other computers (Amiga, ST, etc.).
- Made possible by Datel's unique colour printer driver - now you can have a hardcopy in up to 16 colours!! ● No more to buy - just plug in and print!!

PACKAGE INCLUDES... STAR LC200 COLOUR PRINTER RRP £299.00  
CENTRONICS PRINTER LEAD RRP £9.99  
DATEL COLOUR PRINTER DRIVER SOFTWARE RRP £19.99  
NORMALLY £327.98

**COMPLETE PACKAGE NOW ONLY £239.00**

**COLOUR PRINTER DRIVER AVAILABLE SEPARATELY ONLY £19.99**

- If you already have an LC10 or LC 200 Colour Printer we can supply the Driver separately.

**HOW TO GET YOUR ORDER FAST...**

**TELEPHONE (24 Hrs) - 0782 744707 - CREDIT CARD ORDERS**



WE WILL DESPATCH YOUR ORDER QUICKLY & EFFICIENTLY TO ENABLE YOU TO START RECEIVING THE BENEFITS OF YOUR PURCHASE WITHIN DAYS, NOT WEEKS. ORDERS NORMALLY DESPATCHED WITHIN 48 Hrs. ALL PRICES INCLUDE V.A.T. UK ORDERS POST FREE/EUROPE ADD £1/OVERSEAS ADD £3. PRICES AND SPECIFICATIONS CORRECT AT TIME OF PRESS AND SUBJECT TO CHANGE WITHOUT NOTICE. CALLERS WELCOME - Please reserve goods by telephone prior to visit. ALL CHEQUES/POSTAL ORDERS MADE PAYABLE TO...

**DATEL ELECTRONICS LTD.,**

GOVAN ROAD, FENTON INDUSTRIAL ESTATE, FENTON, STOKE-ON-TRENT, ST4 2RS, ENGLAND  
TELEPHONE SALES ONLY 0782 744707 FAX 0782 744292 TECHNICAL/CUSTOMER SERVICE 0782 744324





# The Amstrad Action

## CHRISTMAS COVERTAPE

It's pressie time again! Santa and all his little elves have been hard at work in his grotto getting together a present for all you loyal AA readers. (After all, you've been very good this year, haven't you?

You haven't missed a single copy of AA...) So what's Santa got in his sack? Sit down, that's right,

next to the Christmas tree, while the fat bearded one hands the brightly wrapped presents out. (No, not you Rod. We mean Santa!)

(Oi! - I heard that! - ed.)



### THE A-SIDE

#### Puzznic

The first of the Christmas goodies on the tape is a playable level from *Puzznic*. It comes from Ocean, that Mancurian software manufacturer that has been keeping gamers happy for years. *Puzznic* is a superb brain-teasing puzzle game, and scored a very respectable 82% (that's a Rave!) in AA62.

Each screen consist of some walls, a cursor (that's you) and lots of blocks with symbols on them. The idea is to match up blocks of the same type. You can drag them left and right with the cursor (but not up or down - the game

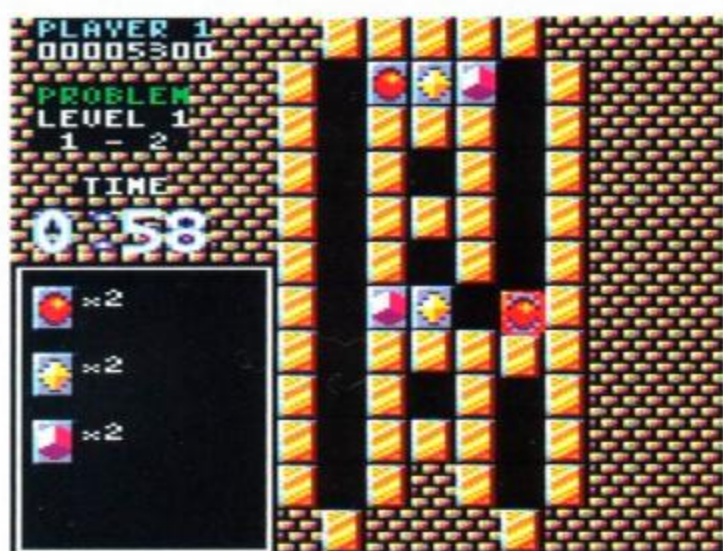

● Play our *Puzznic* demo and you'll be hooked.

has gravity, and the blocks fall when unsupported).

When you match up blocks they disappear. The more you match up at the same time, the more you score. You have to get rid of all the blocks on the screen to progress to the next one. So be careful that you don't end up with an odd one left over!

If you do get stuck, simply press the retry button. You're allowed a maximum of three retries before it's game over. There are four

screens in this demo - each levels consists of four screens. In the proper game there are 144 screens to tease and torment you! So this is just a taster of what's to come!

#### ● Puzznic controls

The game is set to play on joystick, with 'R' as the retry option. To redefine the controls press 'C' when on the title screen.

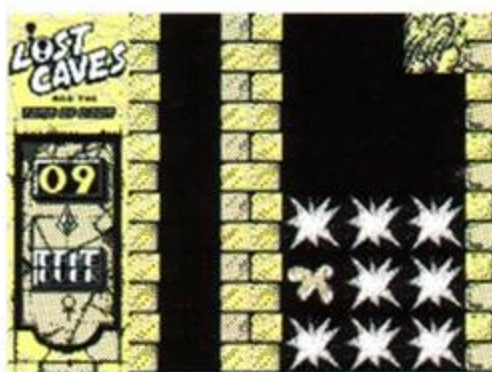

● Bang! - you're dead. (Watch out for the bombs, by the way.)

you'll lose one of your lives. The caves are guaranteed to be full of traps too. You'll have to use cunning to kill the guards, as corner traps loses you a life. Push rocks to the top of them to squash them.

There are plenty of clever tricks and traps to be discovered - lava traps... false walls... bombs... You'll have to leave you to find out exactly how they all work.

Remember, all is not always what it seems. There are sixteen tough and challenging levels to play through. The levels are carefully

#### Lost Caves and the Tomb of Doom

A complete game, courtesy of brilliant budget brokers Players! *Lost Caves* is an arcade-cum-puzzle game. You step into the shoes of an Indiana Jones-type character. Your mission is to collect diamonds from the mud-filled, rock-strewn caves. Ten need to be collected before you can make your escape through the big wooden door - there's at least one of these in each level.

There are plenty of dangers. The mud needs to be dug away as you make your way through the caverns. Plenty of boulders are supported by the mud though, and if you burrow directly underneath them then they'll come a-tumbling down. If they land on your head,



● Quick - go left! Otherwise you're mincemeat.

large, about thirty times as big as the area you can see at any one time!

This special version of *Lost Caves* has been built in cheat! It allows you to select any level you like at the beginning of each game. Just press up and down to choose the level, and press Fire to start it.

#### ● Lost Caves controls

Either use a joystick, or...

- Q Up                    A Down
- O Left                P Right
- SPACE Start/restart

Additionally...

- M Music on/off    ESC Give up

All programs load as follows:  
 Wind to a point just before the star of the program, then type Run"  
 (6128 owners type I tape first)  
 Or hold down the CTRL key and hit ENTER





# THE B-SIDE

## Space Froggy

Space Froggy is a strange game. You're a frog for a start. For some reason that no-one can quite remember, you have to collect nine ROM chips. Oh, and there are 'space monsters' that try and stop you. And as if that wasn't enough, there are some tricky leaps to negotiate.



● Space Froggy looks great – and it's done in BASIC!

You can move left and right, and can jump. It's a platform game, and features moving floors. You'll have to find keys to get through some doors as well.

The game is an example of what you can do with Glenco's *Sprites Alive* package. The game was written entirely with this software, but as you will see, looks pretty darned good!

### ● Froggy Controls

Froggy is joystick only. Use left and right to move, and fire to jump.

- P to pause/unpause
- Q To quit, after you've paused

## Tape to Disk transfer utility

To ensure that disk users have no trouble transferring these super games from the cassette to their disk drives, Glenco has written a transfer utility especially for us.



● Split-second timing is needed to cross the screen.

- Just bung a blank disk in the drive
- "Run" the transfer utility. It will come up with all the instructions you need. The program will transfer all normal Amsdos files, in other words, anything that isn't protected.
- After everything's been transferred, reset the machine. No more lengthy waits for the tape to run through.

And of course, after you've got all your programs transferred from the cover tape, you can use the utility to transfer software from other tapes to disk.

## THINK YOU COULD WRITE A GAME?

Have you ever wanted to write games, but found BASIC just too, well, *basic*? Not any more! Games writing package *Sprites Alive* adds a number of extended commands to BASIC, which are specially written with games writing in mind. There are commands to handle all aspects of gaming, including, of course, sprites.

The package comes complete with a sprite editor. This is a drawing program that allows you to design the graphics for your games. It's easy to use, and even the least artistic person will be able to come up with reasonable graphs!

After a few hours' use, you'll soon be designing your very own games! However, you may feel that the games could do with perhaps a bit more speed. That's where the Compiler comes in.

This part of the program converts your game into machine code, adding that extra touch of speed to make your games playable. The proof is in the pudding. The game *Froggy* was written in *Compiled Sprites Alive*. So if you want to write good-quality games without learning all that com-

plicated machine code, you need *Sprites Alive*.

AND... Glenco has kindly come up with a special offer, exclusively for the benefit of AA readers. For a strictly limited period, you can get yourself a copy of *Sprites Alive and Compiler* for £10 less than the normal price. Or, if you just want the basic version, Glenco is knocking £7 off that.

To qualify for your discounted copy of *Sprites Alive*, cut out the coupon, and send it, along with your cheque/PO made payable to Glenco Software to: **AA Special Offer, Glenco Software, 15 Alford Lane, Whitehouse Farm, Stockton on Tees, Cleveland TS19 0QP.** Make sure it arrives by 31st January 1991, when the offer ends.

● Two versions of *Sprites Alive* are available, the basic version and the compiler version. The offer price for the basic version is £15.95 (normally £22.95). The compiler version is available for £19.95 (normally £29.95). All orders must be sent directly to Glenco, we cannot deal with them here.

Please note that you need a good knowledge of BASIC to use *Sprites Alive*.

### AA SPRITES ALIVE SPECIAL OFFER

Please forward:

- Copy (copies) of Basic Sprites Alive at £15.95 each
- Copy (copies) of Compiler Sprites Alive at £19.95 each

I/we enclose a cheque for .....

Name .....

Address .....

Please Note: Offer expires 31st Jan 1991

## LOST AND FOUND

*Lost Caves* was written by none other than AA's Reviews Editor, Adam Waring. It was a couple of years ago, before he wandered into Future Publishing by mistake and got stuck here ever since.

*Lost Caves* was written in a small office in the Hull, a city otherwise known as the Jewel of the North (by people from Scunthorpe, anyway). The office was in an old warehouse, overlooking a converted dock in the centre of the town. Unfortunately the Council found out and Adam and his colleagues had to flee.

The programming outfit was known as Tag Computer Games, mainly because they couldn't think of anything better. Other games from the Tag stable include *Ninja Massacre*, *Death Stalker*, *Moving Target* and *Arcade Trivia Simulator*.

The question everybody wants to know is: Will Adam be producing any more games for the CPC?

Not bleedin' likely! – for the time being anyway (*thank heaven for small mercies – ed*). Adam's just far too busy putting together your favourite magazine.





# BrunWord

## Complete Word Processing Package £30

BrunWord 6128 is a complete word processing Package consisting of a word processor, spelling checker and card filing programme. It out performs all other word processors for the CPC6128.

BrunWord uses its own high speed screen routine, giving it a very fast response. The editor features are logically arranged, to be easy to learn and the spelling checker with its dictionary load into memory at the same time as the word processor. The whole system is very convenient and exceptionally fast. It is supplied with an introductory tutor file.

### BrunWord Features

- \*40, 80 or 128 columns. \*Typing speed 200 words/min. \*True insert or overwrite. \*Justify or unjustify paragraph or whole text. \*Balanced justification. \*Instant word wrap. \*Block save, move, copy, insert and delete. \*Local editing with word delete/undelete. \*Adjustable margins and TABs. \*Word count. \*Column/Line/Page display with file name. \*Find and replace. \*Help menus. \*Memory files. \*Single character embedded printer commands (18 with 3 codes and 21 with 10 codes). \*Page throw markers. \*Multiple copies. \*Odd/even page headers/footers with page numbers. \*Multi file printing. \*Print specified pages. \*Use any printer. \*True display super/subscript numbers. \*User defined characters. \*Load/Save ASCII files from/to other word processors. \*Files can be encrypted. \*Maximum file size about 9 pages.

### BrunSpell Features

- \*Memory resident programme and dictionary. \*Checks 4,000 words/min. \*30,000 word dictionary. \*No American spellings. \*Add up to 5,000 of your own words. \*Instant lookup. \*Helps to find correct spelling. \*Automatic correction.

### DataFile Features

- \*Alphabetical, numerical, date sorting. \*User defined headings. \*Search routine. \*Data merging. \*Label printing.

### Quotes

"It may seem that I have just written a very long advert for BrunWord 6128 but I haven't, I'm just so impressed."  
(Phil Craven, ACU Feb 90, page 25).

"One such is Peter Brunning's BrunWord 6128 which is without doubt in my mind, the most powerful and friendly word processor available for the 6128 today, with the possible exception of.... BrunWord Elite!"  
(David Dorn, ACU July 90, page 43).

# Info-Script

## Complete Data Processing Package £50

Info-Script includes BrunWord 6128 and BrunSpell. The word processor and database can be resident together, giving the convenience of access to both programmes with no disc delays.

Info-Script is written around the full BrunWord 6128 word processor, enabling many routines to be common. This makes a very compact combination and allows both programmes, 6 pages of text and 1000 addresses to be in the memory at the same time using a standard CPC6128 (or 6128 plus). The great advantage of this is the speed and convenience of no disc delays.

### Database Features

- \*Very fast (e.g. takes 1 second to search 2000 addresses for surname 'Smith', initial 'B'). \*Specific field search and/or progressive general search. \*Instant sort on any field, alphabetical, numerical, date or reverse order. \*3 sets of user defined headings for each file. \*4 markers for instant selection, plus one temporary marker. \*Markers can be cleared or inverted and any pair can be added (allows complex searches to be quickly and easily performed). \*No setting up of field type or length. \*Efficient storage. \*Relational records, Parents, Sons and Daughters. \*Field to field arithmetic. \*Direct data merging into BrunWord. \*Easy direct label printing, 1 or 2 across, left of 2 or right of 2. \*Single or multi-step.

### Data Merging Features

- \*Simple intelligent system, &N &A &D construct full name, full address and date. \*&1 &2 etc specify individual fields. \*Insert or fixed format merging. \*Automatic justify after merging. \*Single step (see before printing) or multi-step. \*Stop any time, go to word processor, restart same place. \*Merge data from several records for summary, invoice, purchase order etc. \*Arithmetic. \*Running total. \*VAT total. \*Conditional loading. \*Conditional printing. \*Repeat patterns.

### 100 Letters £15

100 Letters is a utility for use with Info-Script, enabling pre-written letters to be easily selected and personalised. It is supplied with a library of 50 letters but even the most cautious users will be able to write simple letter patterns to expand the library to '100 Letters'. If multi-purpose patterns are used then the upper limit depends only on the skill of the writer. A third type of letter pattern, aimed at solicitors, doctors, school teachers, estate agents etc, consists of up to ten pre-written paragraphs. The user indicates which of the paragraphs are to be used. 40 separate letters can be added using this style.

Send cheque/PO/Access number/Visa number to:

## Brunning Software

34 Helston Road,  
Chelmsford, Essex, CM1 5JF  
Telephone (0245) 252854 (24 Hours)



## How They Compare

	BrunWord 6128 & BrunSpell	Protex Disc & Prospell	Tasword 6128 & Taspell
Typing into 241 word paragraph	218 w/m	218 w/m	16 w/m
Typing into start of text	218 w/m	218 w/m	150 w/m
Scroll to end, line by line	1 min 27 sec	2 min 2 sec	2 min 25 sec
Justify paragraph of 241 words	17 sec	0.2 sec	34 sec
Change appearance to format and Appearance to Format	1 sec	17 sec	53 sec
Spelling check 3366 words	52 sec	6 min 24 sec	18 min 46 sec
Average speed	3883 w/m	526 w/m	179 w/m
Disc changes	None	8	3
Spelling help 'NECESSARY'	1 sec	12 sec	Not possible
Spelling check word at cursor	0.5 sec	Not possible	Not possible
Screen format - columns	40, 80, 128 Shown	40 or 80 Not shown	80 only Shown
Page boundaries			

# BrunWord Elite

## Elite Word Processor For CPC6128 £55

BrunWord Elite has a unique advantage over its rivals, it can only be used with dot matrix printers. All other word processors are compromised to drive daisy wheel and dot matrix printers.

In the early days of computing a printer was simply a form of electric typewriter. (High quality printing, noisy and very slow). Then came the dot matrix printers, specially designed for computers. (Medium quality printing, not so noisy and much faster). Over the years, the typewriter style has become the daisy wheel printer and although greatly improved, it has been left far behind with the quality, speed and versatility of modern dot matrix printers.

Most word processors, including BrunWord 6128, can use dot matrix and daisy wheel printers. This creates the need for a style of printer control that is acceptable to two very different types of printers.

BrunWord Elite does not have this restriction as it is specifically written to be used only with dot matrix printers. This gives it a unique advantage over other word processors and as a result it is able to provide much more advanced printer control.

This is taken even further, as BrunWord Elite is supplied with an 8 Bit Printer Status Port which allows the programme to continuously monitor the status of the printer, (as well as providing the missing 8th bit for the original CPC6128). This means that BrunWord Elite is able to respond in a more sophisticated way than normally possible. It will wait for ON LINE or <ESC> if the printer is initially OFF or OUT OF PAPER but automatically returns to the editor if the printer is turned OFF.

### 24 Pin Fonts

Before we designed the fonts for BrunWord Elite, we studied several good magazines and concluded that the bulk of the text was printed in fonts that derive from two basic themes. Our fonts Finline and Finetype are variations of these two styles, optimised for dot matrix printers. Finline is supplied in three sizes and Finetype in two sizes. To these we added a display font in computer style type and a straightforward 'Heavy' font. Altogether there are 7 fonts supplied, four are full 24 pin fonts, two are middle size 21 pin fonts and one is a small size 16 pin font.

### BrunWord Elite Features

All the features and speed of BrunWord 6128 and BrunSpell, plus:-

- \*Print in columns \*Specify page layout \*Use special high quality proportional fonts \*Use advanced micro justification with proportional text \*Set printer margins independently \*Move print head up or down paper, specified in inches from top \*Set micro line spacing within text \*Print line or box by specifying size and line thickness \*Use absolute TABs with proportional text \*Download a file directly from disc during printing. \*Can be supplied with Info-Script for data merging.

### Headline

Headline is a print enhancement utility specially designed for use with low cost 9 pin printers. It enables virtually all the features of BrunWord Elite, including the 24 pin fonts, to be used with any 9 pin Epson compatible printer. The only requirement is that the printer must have quadruple graphics (all well known modern 9 pin printers). Even printers which do not have double height printing will be able to use all the features of Headline, including micro justification, normal, double and eight times height, and 1 to 9 times width.

### 9 Pin Elite £55

BrunWord Elite, BrunSpell, Headline, an 8 bit printer status port and 7 'type setting' fonts (fonts are 24 pin in size but only for 9 pin printers). Total price £55.00 inclusive.

### 9 Pin Elite+Info £92

As above but including Info-Script and a backup disc. Total Price £92.00 inclusive.

### 24 Pin Elite £90

BrunWord Elite, BrunSpell, Info-Script, back up disc, an 8 bit printer status port and 7 'type setting' fonts for downloading to a 24 pin printer. Total price £90.00 inclusive.

BrunWord 6128 with BrunSpell & DataFile. . . £30.00  
Info-Script with BrunWord 6128 & BrunSpell. . . £50.00  
9 Pin BrunWord Elite . . . . . £55.00  
9 Pin BrunWord Elite with Info-Script. . . . . £92.00  
24 Pin BrunWord Elite with Info-Script. . . . . £90.00  
100 Letters (needs Info-Script). . . . . £15.00  
Supplied on 3in Disc for CPC6128 or CPC6128 Plus.  
You must state which computer.

All prices are inclusive for UK. Overseas orders sent insured air mail - Europe add £2.50 : Rest add £7.50





# Programming in three dimensions

CONRAD BESSANT continues his series on 3D programming. Last month: two-dimensional basics. This month: first steps in 3D...

Having written a simple program to rotate and shrink two-dimensional objects last month, we can now move on to doing similar things in three dimensions.

As discussed in the previous article, two-dimensional objects such as triangles and squares can be described using a matrix like that shown in **figure 1**, where each column of the matrix represents a corner (vertex) of the object. The top number in each column is the x position of the vertex and directly below it is the y position. Such a matrix is inadequate for describing a three-dimensional object, a pyramid for example, as there is no space to store the z position of the vertex. The z position represents the displacement *into* the screen, just as the x position represents the horizontal displacement of the vertex and the y position represents the vertical displacement. **Figure 2** shows how these positions give rise to an object.

To describe a three-dimensional object, such as the pyramid shown in **figure 2**, an extra space must be added at the bottom of each column to store the z position. An object matrix for the pyramid is shown in **figure 3**; as an example, note that the position of the first vertex is at  $x=0, y=180, z=0$ .

There is one rather large obstacle when trying to plot something like a pyramid on the screen - the object is in three-dimensional

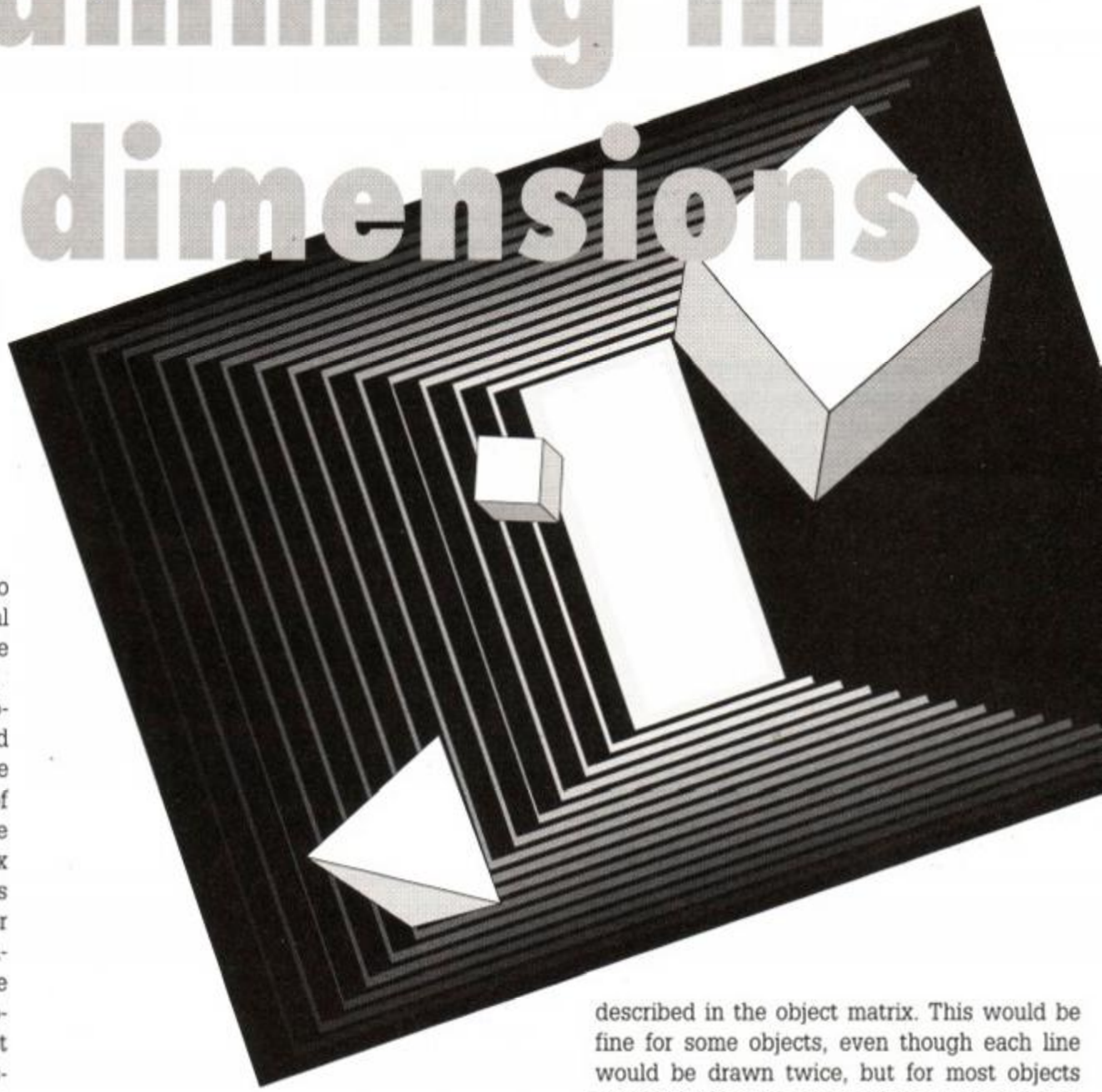

space while the CPC's screen is only two-dimensional. Luckily, we don't need the likes of 3D glasses to trick our brains into thinking that something on the screen is three-dimensional, as there is a simple way to convert a position stored in  $(x,y,z)$  form to the  $(x,y)$  form needed to plot lines on the screen. The formulae to do this are given below:

$$x = x + z * 0.5$$

$$y = y + z * 0.289$$

This is basically a computer implementation of the three-dimensional technique used by draughtsmen, called isometric drawing. It works by plotting the x and y positions on their usual axes, but plotting the z position along an axis at 30 degrees to the horizontal, like the one shown in **figure 2** (maths fans will be pleased to know that 0.289 is half the tangent of 30 degrees).

For simple two-dimensional shapes, like last month's triangle, a simple drawing routine could be used which just joined each vertex to the next one by drawing a line; three vertices gave three lines. With 3D shapes like the pyramid, such a routine is too simple, as eight lines need to be drawn from a matrix of only five corners. If we used last month's routine three of the lines would be missed out.

The most obvious routine to use would be one that joined each point to every other point

described in the object matrix. This would be fine for some objects, even though each line would be drawn twice, but for most objects unwanted lines would be drawn. For example, the square base of our pyramid would have diagonal lines drawn automatically between its opposite corners.

The best solution is to keep a list, for each vertex, of the vertices which we would like it to draw a line to. For example, the lists for our pyramid would be those shown in **figure 4**. Two zeros are used to mark the end of the list. This list can easily be stored in a 5x5 BASIC array, and then retrieved by the drawing routine when it is needed. See **figure 4**.

Now that we have all the information required to store and display three-dimensional objects we can write a program to do it, based on the one given last month. The program is shown as **listing 1**:

## Listing 1

```
10 MODE 0:ORIGIN 320,200
20 n=5
30 DIM object(n-1,2)
50 DIM con(n-1,n-1)
100 FOR x=0 TO n-1
110 READ object(x,0),object(x,1),object(x,2)
120 NEXT x
130 DATA 0,180,0, -200,-100,-200, -200,-100,200,
200,-100,200, 200,-100,-200
200 con(0,0)=2 : con(0,1)=3 : con(0,2)=4
210 con(1,0)=0 : con(1,1)=4
220 con(2,0)=3 : con(2,1)=1
230 con(3,0)=4
```

## DON'T MENTION THE PRINTING

Well, OK, last month the gremlin's struck again. Nothing too serious - only half a sentence at the end of the first page...!

Here is how that paragraph *would* have read if it hadn't been so rudely interrupted:

...But what is the point in doing all this, when similar results could have been generated using a few simple MOVE and DRAW statements? The advantage is that we can now apply simple mathematics to the matrix to transform it, in other words to rotate, change the size of and move the triangle.





```

500 FOR vertex=0 TO n-1
510 pointer=0
520 x=object(vertex,0)+object(vertex,2)*0.5
530 y=object(vertex,1)+object(vertex,2)*0.289
540 vercon=con(vertex,pointer)
550 WHILE vercon>0 OR con(vertex,pointer+1)>0
560 MOVE x,y
570 cx=object(vercon,0)+object(vercon,2)*0.5
580 cy=object(vercon,1)+object(vercon,2)*0.289
590 DRAW cx,cy
600 pointer=pointer+1
610 vercon=con(vertex,pointer)
620 WEND
630 NEXT vertex

```

Lines 100-120 load the pyramid data from line 130 into the object array. Lines 200-230 set up the array containing the lists of connections for each point. Lines 500-630 perform the drawing of the pyramid, using the connection lists, as described above. Line 20 sets n to the number of vertices that make up the object (our pyramid has five vertices).

If you RUN the program in its current state you will notice that something is missing, the animation. Last month matrix transformation for two dimensional objects was explained, and although a similar method can be used for 3D, the same routine can not. This is because each vertex of a three-dimensional object has three values associated with it, these being the x, y and z positions. Because of this we must use 3x3 transformation matrices. A sample one to rotate a 3D object anticlockwise, by just over

11 degrees around the y axis, is shown in figure 5. This can be placed in an array called transform by using lines 300-330 of listing 2. By rotating the pyramid by 11 degrees eight times, we can get the pyramid to perform a quarter of a complete rotation, i.e. a rotation of 90 degrees. As the pyramid has a square base this brings the triangle back to what appears to be its starting position, so the process can be repeated again. After four repetitions the pyramid will have completed a full 360-degree rotation.

Multiplying a 3x3 transformation matrix by a 3xn object matrix is done in a similar fashion to that for 2x2 transformation matrices. The routine given in listing 2 (lines 700-750) will multiply the two matrices and will take into account the extra component of the vertex positions.

Listing 2

```

300 FOR x=0 TO 2 : FOR y=0 TO 2
310 READ transform(x,y)
320 NEXT y : NEXT x
330 DATA 0.981,0,0.195,0,1,0,-0.195,0,0.981
400 FOR colour=1 TO 8
410 GRAPHICS PEN colour
700 FOR x=0 TO n-1
710 t=object(x,0)*transform(0,0)+object(x,1)*
transform(1,0)+object(x,2)*transform(2,0)
720 n=object(x,0)*transform(0,1)+object(x,1)*
transform(1,1)+object(x,2)*transform(2,1)
730 b=object(x,0)*transform(0,2)+object(x,1)*
transform(1,2)+object(x,2)*transform(2,2)

```

```

740 object(x,0)=t : object(x,1)=n : object(x,2)=b
750 NEXT x
800 NEXT colour
900 FOR a=1 TO 8 : FOR b=1 TO 8
910 IF a=b THEN INK b,25 ELSE INK b,1
920 NEXT b : NEXT a
930 FOR c=1 TO 8 : INK c,1 : NEXT c
940 GOTO 900

```

Also included is the colour switching routine introduced last month (lines 400,410 and 900-940). It has been slightly altered, so as to only display eight animation frames, rather than 15. This is to increase speed and to make the pyramid sharper on the display.

Running the program now will give you a rotating pyramid on your screen, at a quite impressive speed for BASIC. You may notice that pixels are missing where animation frames overlap: this is due to the over-simplified colour switching routine, which gives worse results the more complex the object is (i.e. the more vertices it has). This is why only eight animation frames were used. An improved colour-switching routine will be discussed in the next article of this series.

Because the program runs in a continuous loop the only way you can stop the program is by pressing the Escape key. If you do this, the program stops due to an error, you may not be able to see what you're typing. This is a consequence of the colour switching and can easily be put right by typing INK 1,25.

Now that the basic routines of the program

Figure 1

$$\begin{pmatrix} x_0 & x_1 & x_2 \\ y_0 & y_1 & y_2 \end{pmatrix}$$

Figure 2

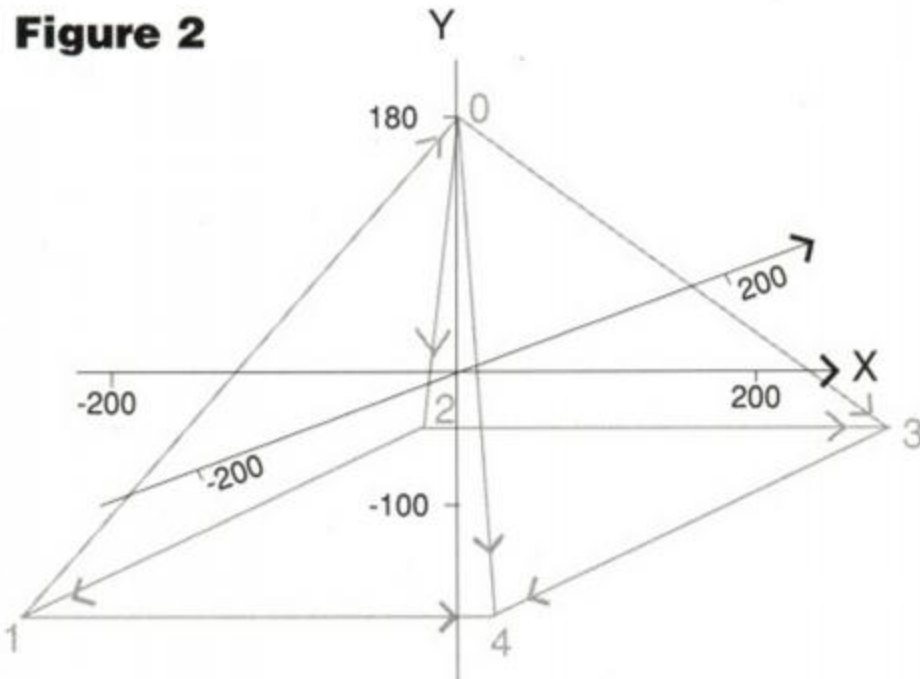

Arrows indicate direction in which the connecting lines are drawn

Figure 3

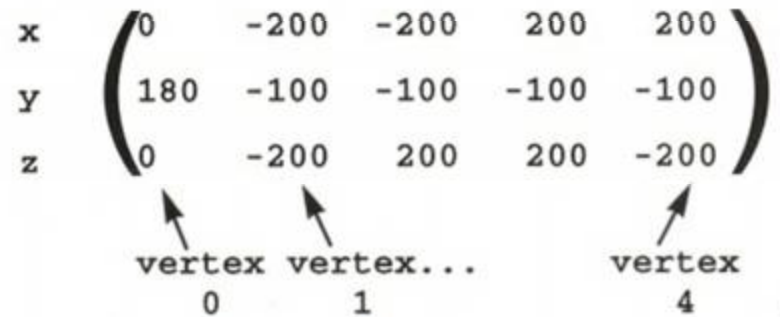

Figure 4

VERTEX	CONNECTS TO
0	2,3,4
1	0,4
2	3,1
3	4

Figure 5

$$\begin{pmatrix} 0.981 & 0 & -0.195 \\ 0 & 1 & 0 \\ 0.195 & 0 & 0.981 \end{pmatrix}$$





have been written, different effects can easily be created by using different objects and matrices. My favourite object for 3D graphics is, shown in **figure 6**. It is meant to be a simple spaceship, but it has been described as anything from a bow-tie to a moth! Note that although this shape is only two-dimensional, it can be moved around in three dimensions using the routines given above. The object can be loaded in instead of the pyramid by amending the lines shown below. Line 20 sets the number of vertices of the object to four, line 130 holds the positions of these vertices in x0,y0,z0,x1,y1,z1... format. Lines 200-230 determine which vertices each vertex connects to, as in the pyramid example. The zeros used to mark the ends of the connection lists do not need to be put into the array in these lines as BASIC arrays are filled with zeros as soon as they are dimensioned.

```
20 n=4
130 DATA -100,-50,150,-100,50,150,100,50,150,100,
      -50,150
200 con(0,0)=1 : con(0,1)=2
210 con(1,0)=3
220 con(2,0)=3
230 con(3,0)=0
```

Because the program so far has been optimised for a square-based pyramid, changing only these lines is not enough to get the spaceship rotating in a full circle - don't forget the pyramid was only really rotating by 90

degrees. Because the spaceship is of a simpler construction than the pyramid, it is perfectly acceptable to have fifteen animation frames rather than the pyramid's eight. To make the program draw these extra animation frames, all you need to do is change all the eights in lines 400, 900 and 930 to fifteens. Now to rotate the spaceship in a full circle of 360 degrees all we need to do is rotate it by 24 degrees 15 times, so line 330 should be replaced by the one below so as to load the 24 degree rotation matrix into the transform array, rather than the 11 degree one used with the pyramid.

```
330 DATA 0.914,0,0.408,0,1,0,-0.408,0,0.914
```

Several useful transformation matrices are shown in **figure 7**, and suitable replacements for line 330 are shown below. For those of you who are not familiar with trigonometry, 'sin a' simply means the sine of angle a, so just substitute the sine of the angle you require into this slot of the matrix (an angle of a=24 degrees is substituted into the lines below; this means 15 frames are all you need to rotate the object 360 degrees). To find the sine of an angle you need look no further than your CPC! Just type DEG to put BASIC into degrees mode and then type PRINT SIN(a), where a is the angle. The same goes for COS a. As an example DEG:PRINT SIN(24) will return approximately 0.408.

Rotate object anticlockwise about the x axis (24 degrees):

```
330 DATA 1,0,0,0,0.914,0.408,0,-0.408,0.914
```

Rotate object anticlockwise about the y axis (24 degrees):

```
330 DATA 0.914,0,0.408,0,1,0,-0.408,0,0.914
```

Rotate object anticlockwise about the z axis (24 degrees):

```
330 DATA 0.914,0.408,0,-0.408,0.914,0,0,0,1
```

Enlarge (to 120% of it's original size):

```
330 DATA 1.2,0,0,0,1.2,0,0,0,1.2
```

Reduce (to 80% of original size):

```
330 DATA 0.80,0,0,0,0.80,0,0,0,0.80
```

All of these transformation matrices will work on all objects such as the spaceship given above, or any other shape you define using lines 20, 130 and 200-230.

Obviously our program is seriously limited at the moment by the over-simplified colour switching, and maximum of 15 animation frames.

● Next month I shall be explaining how to break the 15-frame barrier by using better colour and screen switching, how to speed up 3D animations, and how to arrange objects and programs to create the best three-dimensional effects.

Figure 6

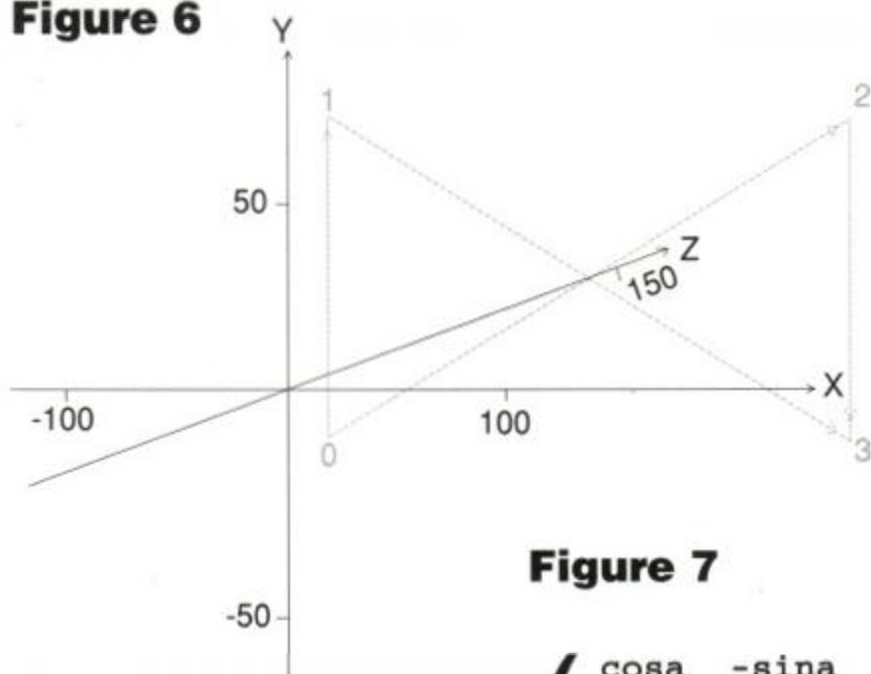

VERTEX	CONNECTS TO
0	1,2
1	3
2	3
3	0

$$\begin{pmatrix} -100 & -100 & 100 & 100 \\ -50 & 50 & 50 & -50 \\ 150 & 150 & 150 & 150 \end{pmatrix}$$

Figure 7

$$\begin{pmatrix} \text{cosa} & -\text{sina} & 0 \\ \text{sina} & \text{cosa} & 0 \\ 0 & 0 & 1 \end{pmatrix}$$

Rotate 'a' degrees about the x axis

$$\begin{pmatrix} 1 & 0 & 0 \\ 0 & \text{cosa} & -\text{sina} \\ 0 & \text{sina} & \text{cosa} \end{pmatrix}$$

Rotate 'a' degrees about the z axis

$$\begin{pmatrix} \text{cosa} & 0 & -\text{sina} \\ 0 & 1 & 0 \\ \text{sina} & 0 & \text{cosa} \end{pmatrix}$$

Rotate 'a' degrees about the y axis

$$\begin{pmatrix} S & 0 & 0 \\ 0 & S & 0 \\ 0 & 0 & S \end{pmatrix}$$

Enlarge by scale factor 'S', i.e. S=2 gives twice the size and S=0.5 gives half the size





# Counting the cost

If you run your own small business you already know about all the paperwork. There's the tax man, VAT, national insurance... you spend half your time book-keeping. And before you even start any job there's the estimate to prepare. ABC may well have a solution in *Costmaster*...

## COSTMASTER

£27.99 disk ● ABC Software ● 31 Magdalen Way, World, Weston-super-Mare, Avon BS22 0PG. Tel: 0934 516714

First of all, make sure your costing needs are complex enough for a program like this. Basically, if what you need takes only a minute on a calculator, then you'll have little need for a computer program which takes longer than that just to set itself up. If, however, your costing work takes up valuable time and contains many repetitive elements, then read on...

ABC Software has produced a program which allows you to cost/estimate a job. It also lets you store details of individual jobs in a customised database which is easily manipulated, and has all a wide range of functions.

The basis of the system is a file into which you add the relevant information either manually or by merging items from the built-in price index, to build up a final costing.

There are three elements to each costing file:

- Firstly, there are the customer details. This

Customer details	COST FILE:GMP	PRICE INDEX:NONE IN MEM	DATE:8
CUSTOMER	>00	(	
SURNAME	>BOURNE	(	
FORENAME	>MICKEY	(	
ADDRESS 1	>2122	(	
ADDRESS 2	>PARAMOUNT AVE	(	
TOWN	>HOLLYWOOD	(	
COUNTY	>LOS ANGELES	(	
POSTCODE	>SE12 5FG	(	
TELEPHONE	>0181232456555	(	
JOB No.	>12	(	
DATE	>25.11.90	(	
EXT. DTR	>	(	

● All the detail you'll ever need on your clients.

is basically a standard database containing information about the client. As well as name and address, it includes an identification number which references it with other parts of the program.

- Secondly, there are the alpha-numeric definitions (getting a tad complicated, this). These allow you to press a single key to correspond to the variable of your choice. The variables are things which change rarely enough to let them be programmed in and saved – an example would be the price of ballcocks in a plumbers' estimating program.

There are up to 36 saveable definitions.

- Thirdly, there is the cost file. This holds the results of the equations which make up the costing. It's the central function of the program.

The three sub-files above can be saved separately, and can even be stored on separate disks. An ID entry system allocates specific customers to specific definitions. This is a fail-safe security device to prevent different definitions becoming crossed.

Entering and controlling text is easy. The main menu allows single keypresses for regularly-used items, and everywhere the Delete

COST FILE OPTIONS	COST FILE:NONE IN MEM	PRICE INDEX:NONE IN MEM	DATE:8
SELECT OPTION	PROGRAMME MONITOR	FILE	
Edit/view cost file	= (E)	:	
Begin cost file	= (B)	:	
Load cost file	= (L)	:	
Save cost file	= (S)	:	
Alphabetical print	= (A)	:	
Numerical print	= (N)	:	
Customer details	= (C)	:	
(F1)	(F2)	(F3)	(F4)
Cost File Options	Price Index Options	Disc Utilities	Programme Setups

● The main menu. Everything is driven by the files.

DISC ACCESS OPTIONS	COST FILE:GMP	PRICE INDEX:	DATE:8
SELECT OPTION	PROGRAMME MONITOR	FILE	
Erase disc file	= (E)	:	
Rename disc file	= (R)	:	
change Drives	= (D)	:	
Catalogue Disc	= (C)	:	
Supercat	= (S)	:	
Format data disc	= (F)	:	
Verify data disc	= (V)	:	
(F1)	(F2)	(F3)	(F4)
Cost File Options	Price Index Options	Disc Utilities	Programme Setups

● Disc management couldn't be clearer.

key will take out any mistakes. The cursor keys can also often be used to move around and change things. Mistakes are easily rectified, and there are standard warnings when you're about to erase data or save changed files.

*Costmaster* uses the standard time-honoured format of one main menu controlling a more complex and detailed 'tree' of other menus. It is very easy to return to the high level main menu (usually by hitting ESCAPE).

A feature which we think is unique to *Costmaster* is the Program Monitor. This gives a recorded display of the last ten 'moves' you made. This removes the worries that you might not have saved your files, or that you haven't updated them recently. It is a very useful feature, and one which many other serious software packages would benefit from.

What this program does is marry together a database of customers with the necessary equations and formulae for a rapid and accurate costing. It is powerful enough to handle as many variables and factors as a small business is likely to need.

The manual is factual rather than fun, but does cover every aspect of the program. It isn't really for the beginner, though. The assumption is that you'll know what you want to do with this program, and that you understand costing and estimation work already. If you're looking for a tutorial, buy a book.

James Leach

PROGRAMME OPTIONS	COST FILE:GMP	PRICE INDEX:	DATE:8
SELECT OPTION	PROGRAMME MONITOR	FILE	
Generic definitions	= (G)	:	
Alphabet' definitions	= (A)	:	
Load definitions	= (L)	:	
Save definitions	= (S)	:	
Print definitions	= (P)	:	
Change inks	= (C)	:	
Define temporary keys	= (D)	:	
Version number	= (V)	:	
(F1)	(F2)	(F3)	(F4)
Cost file Options	Price Index Options	Disc Utilities	Programme Setups

● The Program Monitor (on the right) is very useful.

EDIT/VIEW COST FILE	COST FILE:GMP	PRICE INDEX:	DATE:8
JOB : 12	DATE : 25.11.90	CLIENT : 12	
LINE : 1	ENTRIES : 0	DISPLAY TOTALS : M	
TO	NOTES	DESCRIPTION	QWY COST PER QTY SUBTOTAL TOTAL
A		LABOUR 20 PER HOUR	( 0) 0.00 0.00
B		TRANSPORT 2 PER MILE	( 0) 0.00 0.00
C		BALLCOCK 5	( 0) 0.00 0.00
D		DRYSHER 20P	( 0) 0.00 0.00
E		DRAIN-PIPE 5 PER METRE	( 0) 0.00 0.00
F		PLUG 1	( 0) 0.00 0.00
G		LABOUR 40 PER HOUR (NOT 9-5)	( 0) 0.00 0.00
H		TAP 5	( 0) 0.00 0.00
I		BATH TAP 10	( 0) 0.00 0.00
J		BEND 20	( 0) 0.00 0.00
K		CUP OF TEA DISCOUNT -5	( 0) 0.00 0.00
L			( 0) 0.00 0.00
M			( 0) 0.00 0.00
		FILE SUB T	0.00 FILE TOT T 0.00

● Individual costing variables are stored clearly.

## GOOD NEWS

- A powerful tool. Professional and accurate.

## BAD NEWS

- Occasionally fiddly, requiring concentration.
- Possibly too detailed for many users.



**FREE DISCS &  
SOFTWARE!!**

# 3.5' DISC DRIVES

**FREE DISCS &  
SOFTWARE!!**

Order a 3.5" disc drive from SIREN SOFTWARE between now and 31st December 1990 and receive a free bundle of blank 3.5" discs, and a superb disc utilities package consisting of a Ram disc, Sector Editor, Directory Editor and a Fast Formatter. This bundle normally retails at £19.99, but we're giving it away FREE!!

Everybody knows that our slimline 3.5" disc drives are the most reliable on the market. Our whisper quiet drives have a custom designed in-built power supply that ensures totally trouble free performance. All drives come complete and ready to use and each one is individually tested before despatch. A 12 month guarantee is given with each disc drive.

## PRICES

3.5" DISC DRIVE	£89.99
ROMDOS	£29.99
RAMDOS	£19.99
ROMBOX	£24.99
PC-TRANS	£24.99
3.5" BLANK DISC	£1.00
SOUNDBLASTER	£52.99
ALL PRICES INCLUDE VAT AND UK POSTAGE	



## SOUNDBLASTER

Play all your games with ARCADE QUALITY STEREO SOUND EFFECTS. The SOUNDBLASTER is a stereo amplifier that comes complete with high quality 50 watt 3 way speakers, power supply and FREE stereo headphones. The Soundblaster plugs into the stereo socket on your computer. THE SOUNDBLASTER MAKES THE IDEAL CHRISTMAS PRESENT. Available now priced **£52.99**

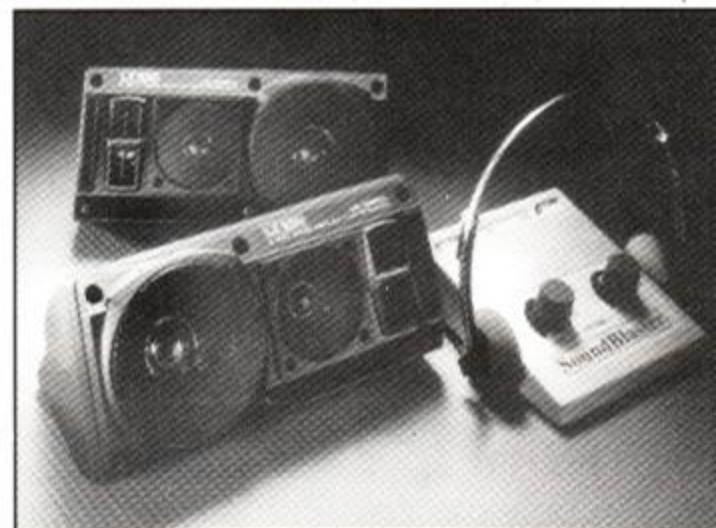

PLEASE SEND ME:- .....

MY COMPUTER IS A CPC 464 664 6128 *Please circle the model of computer.*

I ENCLOSE A CHEQUE/MY CREDIT CARD NUMBER IS .....

NAME: .....

ADDRESS: .....



**POWERDRIFT**  
CASS £4.99  
DISC £7.99

**TUSKER**  
CASS £3.99  
DISC £6.99

# TURBOSOFT

**LASER SQUAD**  
+ EXP. KIT BOTH  
ONLY  
CASS £7.99

**MYTH**  
CASS £4.99  
DISC £7.99

## SPECIALS CASSETTE

	RRP	SRP
C. ....	9.99	3.99
B. ....	9.99	3.99
ed Beast .....	9.99	3.99
ils of Rome .....	9.99	4.99
s Tale I .....	9.99	2.99
ieaze .....	9.99	1.99
Cloughs Football Fortunes .....	14.95	4.99
ie Ghost .....	9.99	2.99
ernia Games .....	9.99	2.99
o .....	14.99	2.99
imental Circus .....	9.99	4.99
ckdown .....	10.99	3.99
on Spirit .....	9.99	3.99
sty Wars .....	10.99	3.99
.....	14.95	4.99
ion .....	10.99	3.99
Strike Eagle .....	9.95	5.99
xy Force .....	9.99	0.99
merlist .....	9.99	4.99
od .....	9.99	2.99
for Red October .....	14.95	6.99
Utd. ....	9.99	4.99
elli .....	9.99	4.99
Warriors .....	9.99	4.99
Thunderbolt .....	9.99	4.99
and .....	9.95	4.99
ania .....	9.95	4.99
ing Shot .....	9.99	3.99
le Saturn Day .....	9.99	3.99
ing Man .....	9.99	4.99
r Scramble Simulator .....	9.99	2.99
r Wonderboy .....	9.99	4.99
& Magik .....	14.99	4.99
letta .....	9.99	4.99
ts .....	9.99	3.99

## AMSTRAD TOP 30 HITS

	CASS	DISC
Badlands .....	7.99	11.99
Batman the Movie .....	7.99	11.99
Chase HQ .....	7.99	11.99
Double Dragon II .....	7.99	11.99
Fire & Forget 2 .....	7.99	11.99
Golden Axe .....	8.99	11.99
Hostages .....	7.99	11.99
Iron Lord (6125 only) .....	n/a	14.99
Kick Off 2 .....	7.99	11.99
Lords of Chaos .....	7.99	11.99
Midnight Resistance .....	7.99	11.99
Monty Pythons Flying Circus .....	7.99	11.99
Night Hunter (6128 only) .....	n/a	14.99
Oriental Games .....	11.99	14.99
Pro Tennis Tour .....	7.99	12.99

## SPECIALS DISC

	RRP	SRP
Afterburner .....	14.99	5.99
Altered Beast .....	14.99	6.99
Annals of Rome .....	14.99	6.99
Beyond the Ice Palace .....	14.99	2.99
Colossus Mah Jong .....	14.99	6.99
Dark Sceptre .....	14.99	4.99
Druid II Enlightenment .....	14.99	4.99
Fair Means or Foul (boxing) .....	14.99	5.99
Firezone .....	14.99	3.99
Galactic Games .....	14.99	4.99
Ghostbusters II .....	14.99	6.99
Hammerfist .....	14.99	4.99
Hunt for Red October .....	14.99	9.99
International Karate .....	14.99	4.99
Knightmare .....	14.99	5.99
Movie .....	14.99	4.99
Mr. Heli .....	14.99	4.99
Ninja Spirit .....	14.99	4.99
Pacland .....	14.99	6.99
Pacmania .....	14.99	6.99
Passing Shot .....	14.99	2.99
Question of Sport .....	17.99	3.99
Running Man .....	14.99	6.99
Sentinel .....	14.99	3.99
Shinobi .....	14.99	6.99
Strike Force Harrier .....	14.99	7.99
The Train .....	14.99	3.99
Time and Magik .....	14.99	9.99
Tobruk .....	14.99	4.99
Toobin .....	14.99	6.99
Vendetta .....	14.99	7.99
Xybots .....	14.99	6.99

## AMSTRAD CLASSICS

	CASS	DISC
Ancient Battles .....	10.99	N/A
Airborne Ranger .....	10.99	13.99
Back to Future 2 .....	8.99	11.99
Bloodwych .....	7.99	11.99
Castle Master .....	7.99	11.99
Chuck Yeagers (AFT) .....	7.99	11.99
Colossus Bridge .....	8.99	11.99
Colossus Chess 4 .....	7.99	11.99
Cricket Master .....	7.99	11.99
Cyberball .....	7.99	11.99
Double Dragon .....	7.99	11.99
Dragon Ninja .....	7.99	11.99
Dragons of Flame .....	7.99	11.99
Emlyn Hughes Int Soccer .....	7.99	11.99
Fiendish Freddy Big Top Fun .....	7.99	11.99
Football Manager 2 + Exp. Kit .....	7.99	11.99
Football Director .....	7.99	N/A
Football Director II .....	N/A	13.99
Gunship .....	10.99	13.99
Heroes of the Lance .....	7.99	14.99
International 3D Tennis .....	7.99	11.99
Jack Nicklaus .....	7.99	12.99
Klax .....	7.99	11.99
New Zealand Story .....	7.99	11.99
Operation Thunderbolt .....	7.99	11.99
Operation Wolf .....	7.99	11.99
Pipemania .....	7.99	11.99
Pirates (6128 only) .....	n/a	14.99
Robocop .....	7.99	11.99
Silent Service .....	7.99	11.99
Southern Belle/Evening Star .....	10.99	13.99
Tank Attack .....	9.99	12.99
Test Drive II .....	7.99	12.99
The National .....	7.99	N/A
Treble Champions .....	7.99	11.99
Vulcan .....	7.99	11.99
War in Middle Earth .....	7.99	11.99
X-Out .....	7.99	11.99

## FORTHCOMING ATTRACTIONS

	CASS	DISC
Action Service .....	7.99	11.99
Adidas Golden Shoe .....	7.99	11.99
Amazing Spiderman .....	7.99	11.99
Apprentice .....	7.99	11.99
Beach Volley .....	7.99	11.99
Dark Century .....	7.99	11.99
Days of Thunder .....	7.99	11.99
Dick Tracy .....	7.99	11.99
Driving Force .....	7.99	11.99
Escape from Planet of the Robot Monsters .....	7.99	11.99
European Super League .....	7.99	11.99
F-16 Combat Pilot .....	10.99	13.99
Gazza 2 .....	8.99	11.99
Gremlins 2 .....	7.99	11.99
Judge Dredd .....	7.99	11.99
Lotus Esprit Turbo Chall. ....	7.99	11.99
Mystical .....	9.99	12.99
N.A.R.C. ....	8.99	12.99
New York Warriors .....	7.99	11.99
Night Breed .....	9.99	13.99
North & South .....	9.99	12.99
Onslaught .....	7.99	11.99
Pinball Magic .....	7.99	11.99
Player Manager .....	7.99	11.99
Saint Dragon .....	7.99	11.99
Sly Spy .....	7.99	11.99
STUN Runner .....	7.99	11.99
Suzuki Challenge .....	7.99	11.99
Tennis Cup 2 .....	7.99	11.99
The Champ .....	7.99	11.99
Tie Break .....	7.99	11.99
Total Recall .....	9.99	12.99
Twin World .....	7.99	11.99
UN Squadron .....	8.99	11.99
Welltris .....	7.99	11.99
Xenophobe .....	7.99	11.99
Z-Out .....	7.99	11.99

Please note that the majority of the forthcoming attractions are not released at time of going to press. These will be despatched within 24 hours of release subject to availability.

## AMSTRAD CARTRIDGE

Klax .....	23.99
Batman the Movie .....	23.99
Operation Thunderbolt .....	23.99
Robocop 2 .....	23.99
Chase HQ 2 .....	23.99
Shadow Warrior .....	23.99
Double Dragon .....	23.99
Barbarian 2 .....	23.99
Crazy Cars 2 .....	28.99
Fire & Forget 2 .....	28.99

**MIND-STRETCHERS**  
CASS OR DISC  
£13.99  
Monopoly  
Scrabble  
Cluedo

**WORLD CUP COMPILATION 90**  
Cass £8.99  
Disc £11.99  
Kick Off, Gary Lineker's Hotshot, Tracksuit Manager.

**SEGA MASTER MIX.**  
Cass £11.99  
Disc £14.99  
Super Wonderboy, Crackdown, Dynamite Dux, Thunderblade, Turbo Outrun

**TOLKIEN'S TRILOGY**  
Only 8.99 Disc £11.99  
The Hobbit  
Lord of the Rings  
Shadows of Mordor

**WINNERS ONLY £10.99 DISC £14.99**  
Thunderblade, Led Storm, Indy Jones & Temple of Doom, Blasteroids, Impossible Mission II

**MAGNIFICENT 7**  
Only £7.99 Disc £13.99  
Head Over Heals, Cobra & Arkanoid, Short Circuit & Wizball, Frankie Goes to Hollywood, Great Escape & Yie Ar Kung Fu

**STAR WARS TRILOGY**  
CASS ONLY £6.99  
Star Wars, Empire Strikes Back, Return of the Jedi.

**DYNAMITE**  
Only £11.99 Cass Only.  
Afterburner, Last Ninja II, WEC Le Mans, Double Dragon

**LEADERBOARD PAR 3**  
Only £11.99 Disc £14.99  
Leaderboard, Leaderboard Tournament, World Class Leaderboard

**PLATINUM COLLECTION**  
CASS £11.99 DISC £14.99  
Ghouls n Ghosts, Strider, Black Tiger, Led Storm, Forgotten Worlds

**LOOK! MEGA OFFER LOOK!**  
For every £10 spent you can choose a free game from the list below  
Mr Weems and the She Vampires, Mega Apocolypse, Dandy, High Frontier, Hijack, Sailing, Mandragore, Split Personalities, Warlock, Ballblazer, Death Or Glory, Stifflyp & Co, The Train  
(CASS ONLY)  
All the above available @ £1.99 each

Please charge my Access/Visa No: ..... Expiry date: .....

**ORDER FORM**

Please supply me with the following for Computer .....

Titles	Price

Customer Number .....

DATE: .....

NAME: .....

ADDRESS: .....

.....Post Code.....

TEL: .....

AMSTRAD ACTION JANUARY '91

Please make cheques & PO payable to **Turbosoft**

Credit card orders taken. Payment cashed only on despatch. Orders under £5 add 75p P&P. For first class add 75p P&P UK only. EEC countries add £2.00 per item. Non EEC countries add £3.00 per item. Express airmail £4.00 per item. All items subject to availability. All prices subject to change without notice. E. & O. E.



LORDS OF CHAOS  
CASS £7.99  
DISC £11.99

SIM CITY  
CASS £8.99  
DISC £12.99

# TURBOSOFT

HOSTAGES  
CASS £7.99  
DISC £11.99

HARD DRIV  
CASS £4.99  
DISC £7.99

## EDUCATIONAL

	Cass	Disc
Animal/Vegatable/Mineral	7.99	11.99
Answer Back Junior	7.99	10.99
Better Maths 12-16	8.99	13.99
Better Spelling 9-14	8.99	13.99
Biology 12-16	8.99	13.99
Chemistry 12-16	8.99	13.99
Chemistry GCSE	11.99	14.99
French Mistress Adv. + Beg	12.99	14.99
Fun School 2 Under 6	7.99	9.99
Fun School 2 6-8	7.99	9.99
Fun School 2 8+	7.99	9.99
General Science	n/a	7.99
Geography Quiz 10+	8.99	13.99
German Master Adv. + Beg	12.99	14.99
Happy Letters	7.99	11.99
Happy Numbers	7.99	11.99
Happy Writing	7.99	11.99
Magic Maths (4-8)	8.99	13.99
Map Rally	7.99	11.99
Maths Mania (8-12)	8.99	13.99
Physics 12-16	8.99	13.99
Physics GCSE	11.99	14.99
Prof. Plays a New Game	14.99	19.99
Spelling Add On	4.99	7.99
Three Bears	n/a	13.99
Weather/Climate 12-17	n/a	13.99
WordHang	7.99	11.99
Worldwise	7.99	11.99
Italian Tutor	12.99	14.99
Spanish Tutor	12.99	14.99
Fun School 3 under 5	9.99	12.99
Fun School 3 5-7	9.99	12.99
Fun School 3 7+	9.99	12.99
Sooty's Fun With Numbers	7.99	11.99
Thomas Tank Engines Words	7.99	11.99

### IN NOW T.N.T.

CASS £11.99  
DISC £19.99  
Hard Drivin', Toobin,  
APB, Dragon Spirit,  
Xybots

### IN NOW HOLLYWOOD COLLECTION

CASS £11.99  
DISC £14.99  
Robocop, Ghostbusters 2,  
Indiana Jones, Batman The  
Movie

NINJA SPIRIT  
CASS £4.99  
DISC £7.99

GHOSTBUSTERS II  
CASS £4.99  
DISC £7.99

DR. DOOMS  
REVENGE CASS  
£3.99 DISC £6.99

CF2 BLANKS  
SINGLE £2.50  
BOX 10 £18.99

TIN TIN ON THE MOON  
CASS ONLY  
£2.99

3" DISC  
CLEANING KIT  
£3.99

AMDRUM  
CASS ONLY  
£7.99

AFTERBURNER  
DISC ONLY  
£5.99

HAMMERFIST  
CASS £4.99  
DISC £7.99

XYBOTS  
CASS £3.99  
DISC £6.99

SHINOBI  
DISC ONLY  
£6.99

CAPTAIN BLOOD  
DISC ONLY  
£3.99

LASER SQUAD  
CASS £4.99  
DISC £7.99

RUNNING MAN  
CASS £4.99  
DISC £7.99

VINDICATORS  
CASS £3.99  
DISC £5.99

MOUSE  
MATS  
£4.99

VENDETTA  
CASS £4.99  
DISC £7.99

BOMBER  
CASS £6.99  
DISC £9.99

Inc. Shrinking Sphere  
CASS £2.99  
DISC £4.99

BOBO  
CASS ONLY  
£2.99

CYRUS 2 CHESS  
DISC ONLY  
£6.99

QUESTION OF SPORT  
CASS OR DISC  
£2.99

IMPACT  
CASS  
£2.99

AFTER  
THE WAR  
£3.99

## UTILITIES

	Cass	Disc
Maxam	14.99	1
Mini Office 2	11.99	1
Tascopy	11.99	1
Tasdiary	n/a	1
Tasprint 464	11.99	1
Tasword 464	19.99	2
Tasword 6128	n/a	2
Promerge	n/a	1
Prospell	n/a	1
Protect	n/a	1
Mastercalc 6128	n/a	2
Masterfile 3 (664/6128)	n/a	2
Money Manager	n/a	2
Sprites Alive Basic 6128	n/a	1
Sprites Alive Comp. 6128	n/a	2
Devpac 80	n/a	3
Pascal 80	n/a	3
Tasspell	n/a	1
Hisoft C Compiler	37.99	3
Hisoft Knife Plus	n/a	1
Hisoft Forth	n/a	1

### IN NOW HEROES CASS £11.99 DISC £14.99

Licence to Kill, Star Wars,  
Running Man, Barbarian 2

### IN NOW WHEELS OF FIRE CASS £11.99 DISC £19.99

Chase H.Q., Powerdrift, Ha  
Drivin', Turbo Outrun

## Turbosoft

Unit 6 & 7  
Acacia Close  
Cherrycourt Way  
Industrial Estate  
Stanbridge Road  
Leighton Buzzard  
Beds. LU7 8QE

Office hours are  
Monday to Friday  
9.00am to 5.00pm  
Saturdays  
10.00am to 4.00pm

All prices include VAT

Tel: (0525) 377974  
Fax: (0525) 852278

Independent Stockist.  
Riomhaire Software,  
Dublin Bazaar,  
Unit 34 Thomas St,  
Dublin 8, Eire.  
Shop prices will vary.  
Personal callers only.

(Personal callers welcome)

### HOW TO FIND US.....

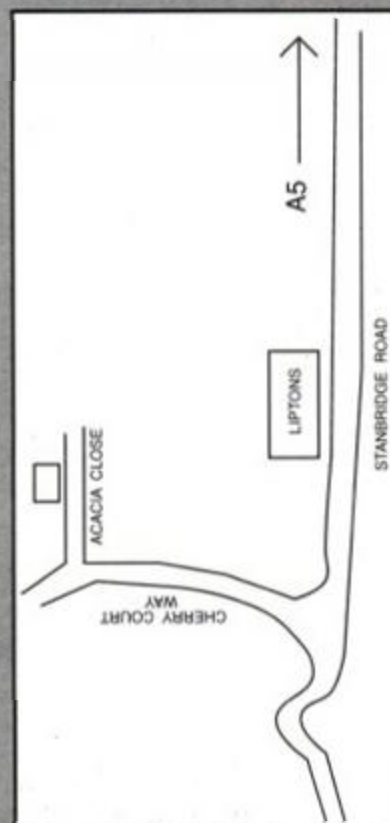
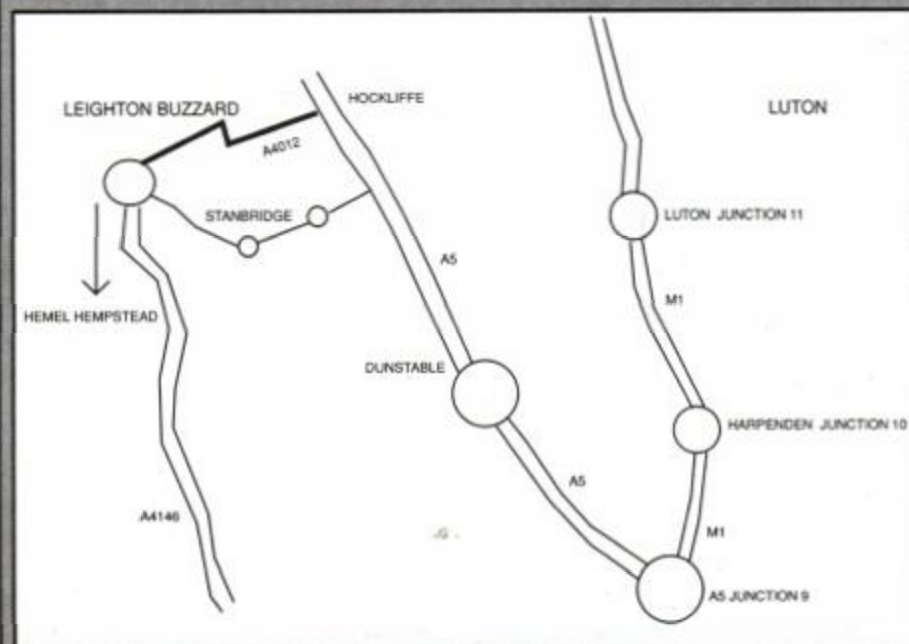

Maps showing direct routes from the motorway and A5



THE  
JANUARY  
COMPETITION



THE  
COMMODORE AMIGA

OR

SEGA MEGADRIVE

(Plus Game of Your Choice)

OR

NINTENDO

(Mega Turtle Gift Pack)

OR

ATARI LYNX

In The FANTASTIC **DIAL—A—QUIZ** CHRISTMAS Computer Competition

Answer 4 simple computer related questions and by this time NEXT MONTH YOU could be the Lucky Winner of one of FOUR Superb First Prizes in this months DIAL—A—QUIZ "Welcome to 1991" Computer Competition.

eg. QUESTION: In which game would you find Professor Elvin Atombender?  
ANSWER: 1. Double Dragon.  
2. Impossible Mission.  
3. Monty Python's Flying Circus.

It's THAT simple!

And REMEMBER, you can enter ALL Competitions as many times as you like.

Commodore Amiga Hotline: 0839—121—161

Sega Megadrive Hotline: 0839—121—162

Nintendo Console Hotline: 0839—121—163

Atari Lynx Hotline: 0839—121—164

One first prize in each competition. Winners are chosen at random from all correct entries received. Closing date 20th January 1991. All calls last approximately 4 minutes and if you are under 18 we ask you to please obtain your parents consent before you dial.

Calls are charged at 33p per minute cheap rate. 44p per minute at all other times.

OCTOBER RESULTS:

CHRISTOPHER MITCHELL From KENT..AMIGA  
IAN HIGGINS From LEEDS..SOFTWARE  
STEPHEN JONES From ASHTON-UNDER-LYME..SOFTWARE

P.Grove. DIAL—A—QUIZ. P.O. BOX 11, SKEGNESS, LINCS. PE25 3NL



# Action Test

Gremlin's at it again, this time with its first console game...

## SWITCHBLADE

Gremlin's first console game takes a bit of getting used to. The graphics initially look distinctly second-rate, the gameplay seems simple and there doesn't seem to be much going on. Don't be fooled. Play on, and you'll find yourself becoming immersed in a huge, compelling and highly challenging epic...



● Does *Flimbo's Quest* out-cute *Rainbow Islands*? Page 48 has the answer...



● Can you save the world from arch-villain Stromberg? *Spy Who Loved Me* is on page 66...



● Another *Dizzy* sequel? An excellent budget outing or a jolt of a program (sorry)? Find out on page 63...

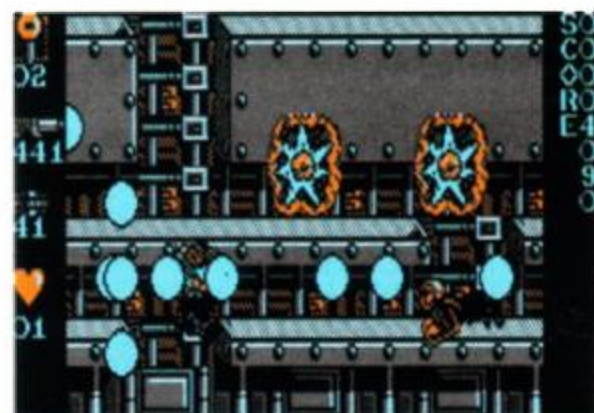

● Is it worth staying up for *Midnight Resistance*? Page 68 has the answer...







# FLIMBO'S QUEST

System 3 • £9.99 cass, £14.99 disk joystick/keys

Imagine living in a place called Dewdropland. Where the sun shines brightly every day, and people jump out of bed and look forward to the day ahead. A cute land filled with gingerbread houses, with is no unpleasantness at all. No wars, unemployment, inflation or trouble. Wouldn't it be great?



● Oooh! Couldn't you just eat that cute house?

The answer is, of course, no. It would be horrible. Just imagine how bored you'd feel. You'd deliberately try and mess things up just to make it interesting.

And one man who has tried to is Professor Fransz Dandruff. He's kidnapped Pearly, Dewdropland's reigning beauty queen. As nothing in Dewdropland remotely approaches ugliness, you can imagine how utterly scrummy young Pearly is.

However, her disappearance has not gone un-noticed: her cute co-habitee Flimbo has vowed to rescue the poor dear from the slimy yet surprisingly strong clutches of Dandruff. To this end, he has set off towards Dandruff Manor, where she's being held (very tightly).

Before reaching Pearly, Flimbo must negotiate seven levels of baddies. These are the Genetically Undesirable Mutants that the Prof has been breeding in his lab. Rather than pity

these poor creatures, Dewdropland's population want to see them exterminated (presumably because they're not beautiful enough to live). Flimbo has a gun, and gets twenty quid for each mutant he murders. This money is very useful, because each level has a shop. The proprietor of these shops is a curious individual known only as Dazz Bazian. He sells various useful items, such as Temporary Invulnerability, a better gun, scrolls and an extension to your time limit.

The scrolls are the key to each level. You, must collect a certain number. You can get them by killing any flashing mutants, who drop them, or alternatively by saving up your money and buying them in the shops. Usually you'll get all the scrolls you need by a combination of these methods. Collect enough and you'll proceed to the next level.

As you explore each level, you come across unexpected hazards, extra rooms (packed with loot) and other surprises. All the time you'll be slaughtering hordes of mutants and collecting the little piles of dosh they leave behind.



● Zap those marauding molluscs. They're worth £20!

Each level has one of Dazz Bazian's chain-stores (which, like McDonalds, all look the same inside). They also all have a secret room at each end of the playing area. There are one or two new mutants in every new level, but they behave in a very similar way to the ones that they have replaced on the previous level.

A clock ticks down in the bottom right-hand corner. This time limit dissuades you from staying in a safe spot and blasting the mutants until you have enough money to buy all the scrolls you need.

## SECOND OPINION

*"Gameplay is extremely limited. You just kill, kill and kill until you have enough scrolls to get to the next level. The graphics are none too special, either."* AW

The graphics are, like Dewdropland itself, bright and cheerful. They are smooth, large and cute, but because of the detail on some of the levels, can look rather confusing. Flimbo sometimes merges with the backgrounds on some screens, to become a jumble of colours. The first screen suffers from this more than the others.



● The third level. Things get tricky for our little pal.

Flimbo waddles around wearing a Babygro, and with a beanie on his huge head. This hydrocephalic appearance is as cute as any could stand without feeling nauseated. The mutants also look good. One type seems so harmless and pathetic that it's almost a pity to waste them in their droves. But at £20 a head, it's certainly worth it.

Sound is simple, and contrasts rather with the sugary-sweetness of the display. There is a nice, fluffy theme tune, too.

*Flimbo's Quest* is cutesy, colourful and not too difficult. There are no hard puzzles, and not many split-second leaps. There are two ways to get through the levels; firstly just kill everything on one or two screens until you've enough money to buy your way up; secondly to explore, and to kill the scroll-bearing mutants as and when you find them.

The lack of real challenge means that you generally lose your lives by making silly mistakes, which can get very tedious. This lends the game an infuriating addictiveness. You know that you can get to the next level, but you scream and shout when you don't make it.

This is a compulsive game. It's very frustrating and you'll keep playing with grim determination. This is totally contradictory to the sweetness oozing out of the program, but it works, and it's fun.

James 'sweetness and light' Leach

### FIRST DAY TARGET SCORE

Get to Level Three

### The Verdict

**GRAPHICS** ..... 75%

*Rainbow Islands* still has it, but this is close.

**SONICS** ..... 56%

A wee bit dour.  
 A nice tune, though.

**GRAB FACTOR** ..... 77%

Not too difficult to understand or play.  
 You can't really get lost, either.

**STAYING POWER** ... 66%

Can get a bit samey.  
 Each level requires a similar approach.

**AA RATING** ..... 73%

Not too difficult but very frustrating.



his shop will try and flog you guns, scrolls and extra time.



**BBC**

# edd the duck!



WEATHER  
SPECIAL  
BBC  
CHI

Available:-  
SPECTRUM, AMSTRAD &  
COMMODORE 64 - £ 9.99  
ST & AMIGA - £24.99



IMPULZE

"BBC" and "EDD THE DUCK" are trademarks  
of the British Broadcasting Corporation.  
© BBC 1990 Licensed by BBC Enterprises Ltd.  
IMPULZE  
P.O.Box 17, Houghton-le-Spring, Durham DH4 6JW.





# Switchblade



Hiro is the last of the Bladeknights, a trained warrior with a hi-tech re-programmable cyber-arm which can accept any number of different and ever more destructive weapons. He can also kick and punch hard enough to demolish walls and leap huge distance with one thrust of his mighty limbs. He's also about three feet tall, shaped like a seven-year-old Schwarzenegger and wears his cap back to front. We won't worry about that, though.

Needless to say, Hiro has a rather important task to perform. Namely, to rid the world of Thraxx of the evil Havok, who has dominated the world since the shattering of the Fireblade (you are paying attention, aren't you?). As Hiro, you must explore the Undercity beneath the surface of Thraxx, battling Havok's evil and ghastly minions and assembling the bits of the Fireblade so that you can use it against the evil geek himself.

OK, never mind the scenario, let's get cracking... oh, is that it? Hmm, click past the opening text screens and your first glimpse of the game itself is worrying. Um, the graphics only take up half the screen, and, er, there's only one colour, if you don't count black and white...

Yes, well, let's not worry about the graphics for a moment – what does it play like? Well, Hiro's a game little chap. Admittedly, there's no great urgency about his walk – more like

somebody pushing a trolley around Waitrose than battling his way to a confrontation with an evil megalomaniac. However, he is nimble enough in a tight corner, delivering devastating low kicks, high kicks and punches on demand and leaping huge gaps (with an appropriate run-up).

You start out on the surface of Thraxx and can travel either left or right. Left will take you – via a nasty creature and some nasty flames – to a hole in the ground you don't see until you step onto it (depending on whether you can step on something that only exists because it isn't there, er,

plement of vitality. If he gets hit by a monster, though, his vitality bar starts *shrinking*. When it gets to zero, he loses a life. To combat the various monsters he'll encounter, Hiro can deliver low kicks, high kicks and punches. It all depends on how long you keep the Fire button pressed. Let it go almost immediately and Hiro delivers a jab to the forehead. Keep it pressed a moment longer and he launches a boot at the

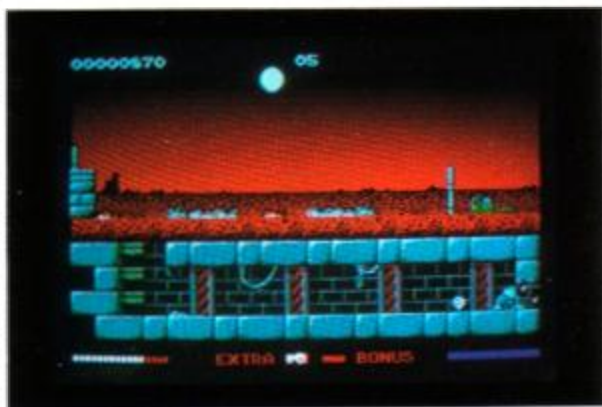

● Get that heart! It's extra energy and you need it.

um...). Suddenly you're in a different – underground – world. So this is where all the colours are! Yup, once you're underground, *Switchblade* suddenly looks a whole lot better.

Hiro starts out with five lives and a full com-

### HAZARDS AND ENEMIES

	<b>Flames</b> 0 points		<b>Flamehogs</b> Savage armoured boar men, carrying arm-mounted flame throwers. 300 Points.
	<b>Proximity sensing floor spikes</b> 0 points		<b>Bladeballs</b> 0 points
	<b>Spikelice</b> Mutant insectoids covered with poison tipped spines. 50 points.		<b>Kobras</b> Merciless robot snakes with venomous hypodermic fangs. 300 Points.
	<b>Cybats</b> Lethal bat creatures that strike with blade claws. 100 Points.		<b>Striders</b> Hideous roborganic war machines armed with high voltage electric stings. 300 Points.
	<b>Mansnakes</b> Fierce cybernetically enhanced serpent-men armed with powerful mechanical claws. 100 Points.		<b>Razorbe</b> Robot orbs bristling with spinning blades. 350 Points.
	<b>Spiderbe</b> Wall climbing robot sentries. 100 Points.		<b>Reptlions</b> Powerful lizard men that rely upon pure strength as their only weapon. 250 Points.
	<b>Creetheds</b> Armoured mutant warriors that fight with razor sharp wrist knives. 200 Points.		<b>Scorpoide</b> Robot scorpion creatures with spinning blade stings. 250 Points.

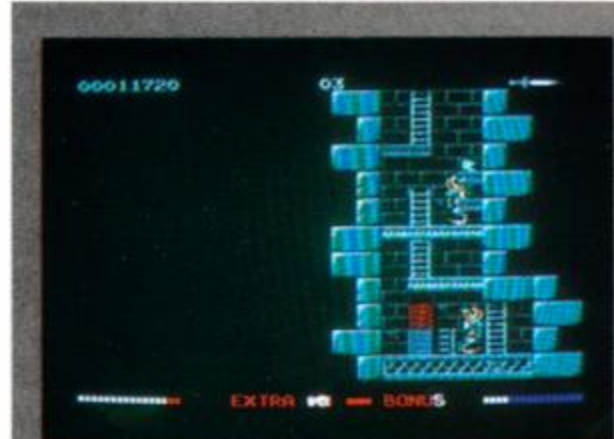

● Hmm – bit of a sticky wicket here. You can knock off that Mansnake next to you, but you'll take a lot of damage going down the ladder to the next...

● ...But if you kick that wall in, lo and behold! – a whole new room and an easy way round. Always look out for small wall blocks showing extra detail to the others...

● ...Now you can just go back and kick that other Mansnake's head in – at no personal risk to yourself, too. There are a number of little puzzles like this to be solved with a little extra thought.





**VERDICT**

**FIRST DAY TARGET SCORE**

Find three Fireblade bits

**GRAPHICS 96 %**

**SONICS 86 %**

**GRAB FACTOR 81 %**

**STAYING POWER 93 %**

**AA RATING 94 %**  
Huge, and so playable!



enemy's visage, keep it pressed until your 'kickometer' (bottom of the screen) reaches maximum and you can kick the other guy's legs off. Brilliant!

*Switchblade* is basically a *Rick Dangerous*-style game, where you must explore the underground corridors, avoiding traps and dealing with various nasties on the way. Unlike *Rick Dangerous*, however, you can't actually 'see' a room until you go into it. So, as you're exploring, you really are in the dark – and that adds a great deal to the game. *Switchblade* doesn't have *Rick's* humour, either, or its range of puzzles, but it makes up for it with a wide variety of evil beasts and a whole host of collectable



1. Now you've got a problem – how do you get that bit of the Fireblade, top right?



2. Well, how about if you start off by jumping on that thar packing case?



3. OK, now you can jump onto the next one – we're getting there...



4. Grasping your courage in both hands you leap into space...



5. Eeek - just made it!



6. Now you turn round, hitch up your pants and...

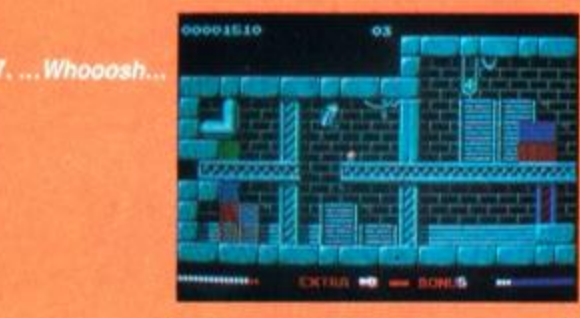

7. ...Whoosh...



8. Made it! All you've got to do now is repeat that trick with the packing cases...



9. ...and Bob's yer uncle!

weapons and bonuses. Given this range of weapons and opponents, *Switchblade* is as much a kick-em-up as an exploration game, but some of those puzzles are really very subtle, particularly as you can come at many of them from different directions.

If *Switchblade's* graphics take a while to

impress, the same can be said of the gameplay. It starts off seeming a bit easy and shallow, but gradually escalates into a very impressive and challenging game indeed. In terms of size, it's a monster. With a total of over 150 screens to explore, you're talking about one huge game area.

The graphics themselves really are very good indeed. Although it's all in four-colour mode, the programmers have used split-screen techniques to bump up the colour count right from the start. And there are enough hardware sprites in there masquerading as background detail to push up the number of on-screen colours to nearer twenty than four. Combine that with the high resolution of Mode 1 and you've got a console game that looks like it's playing on a 16-bit. (In fact, although the ST version's sprites are better, the Amstrad's backgrounds are miles ahead of the 16-bit machine's!)

The soundtrack plays continuously, and is original and listenable. There are no sound effects, but that doesn't take much away from the game.



Your vitality meter. (You're looking a bit green about the gills at the moment...)

Collect the letters that spell out these words and you get a goodie.

Your currently selected weapon and, to the right, how much ammo you have left.

Your combat meter – tells you how much power you've got stacked up for your next hit.





For Gremlin to use the four-colour mode on the console – especially when people are expecting spectacular new standards of graphics – is a brave choice, but once any initial disappointment has worked off, the overwhelming impression is of very subtle, and very, very good visuals which really do make the best of the new hardware.

The other striking thing about the game is its sheer size – it just goes on and on! And the further you go, the better the puzzles, the enemies and the fun factor.

If *Burnin' Rubber* on the console set new standards for driving games, then *Switchblade* does the same for platform adventures. It may not grab you by the short 'n' curlies straight away, but it slowly, inevitably, sucks you in until you simply can't leave it alone. What an excellent game!

Rod Lawton

### SWITCHBLADE TIPS

- When you can, jump onto a crate before taking on the enemy. Most can't hurt you while you stand one level above them, but you can merrily kick their lights out.
- When entering a screen, wait for the monsters to appear. Note the point at which they generate for future reference. Try to take them on one at a time and try to get them all. Once all the monsters on a screen are dead they don't regenerate, even when you come back later.
- Take careful note of which weapon you're carrying. You can only repeat-fire after your last missile has exploded and some traverse the entire length of the screen, making them useless in close-combat.
- Avoid stepping off into space without knowing what's below. There are some stages in the game which involve large falls, and this can sap your vitality badly.
- Look out for where the vitality power-ups can be found. Plan your movements so that you pick up the energy when you most need it.
- You only jump a short distance if you leap from a standing position. Take a run-up to jump further.
- If a monster appears at an awkward place/time when you enter a screen, leave it immediately and try coming back.
- Monsters always home in on you, so use the platforms and different floor levels carefully to get them into the position you want, when you want.
- The boss monsters have particular movement and firing patterns. You'll lose energy sussing them out, but once you have even these monsters will (should!) prove easy meat.
- To make sure you're not missing out any bits of *Fireblade*, map the game as you go along. It'll pay off far better than simply trying to do it from memory, and you will find some safer short-cuts round some puzzles.
- Remember, there is no time limit, so you can analyse a problem for as long as you like.
- If you come up against a brick wall (literally), look carefully for square bricks showing more detail than the rest – you can kick these away.

## TECHNICALLY SPEAKING...

*After playing Switchblade for a few days, we were so impressed we took Gremlin's technical guru James North-Hearn to one side and gave him a grilling...*

**We've got *Switchblade* now, we've been playing it for a few days, and we think it's really good.**

Yes, we're really pleased with it.

**It's a very big game, as well, isn't it?**

It's a massive game – there's an awful lot in there.

**Now we understand that you've used the hardware sprites to actually add more colours for the backgrounds?**

We went to 4-colour mode because we felt that because of the size of detail, in the 16-colour mode it would not have looked anywhere near as impressive as it does. We used the stippling effect to add shading etc, which I think you'll agree works. Because we went to 4-colour mode we wanted to add more colour, so there's already – without any hardware sprites or anything – there's already two splits in it, which are noticeable at the top and bottom. And I think at most times we have at least six colours on and sometimes eight colours on screen. By splitting the screen and changing the palette, at the top, the play area and the bottom – if you count the colours you'll see there's always more than four. Because down at the bottom you've got a blue and a red, then you've got all the colours within the game. And there's also sometimes a different colour at the top. So that's easy to implement on the console. In addition to that, we added colour to the backgrounds by actually making the backgrounds out of the 16-colour sprites. So we built up the backgrounds with normal background techniques, but also added hardware sprites to add colour throughout the game.

**So the sprites are in 16-colours, but you get higher resolution for the sprites, don't you, than in normal 16-colour mode in the backgrounds...?**

What we didn't do is make very elaborate sprites, really big ones, and just plonk them on the screen for the sake of it, because that would have ruined the look of the game. The sprites are actually in key with the rest of the game. They fit. You can't tell they're in any way different from the backgrounds except that they're colourful. We've put sprites on every screen, so every screen contains well in excess of the normal four colours.

**The thing is, we also took a look at the ST version – and we've been having a bit of a debate with the ST Format lads – but we actually reckon that the console version is better...**

...Slightly better, yeah!

**What do you think?**

For a start off, the product makes a very good console type of game. That's one of the reasons you think it is better, because on the ST you're aiming – in a sense – to do a different kind of thing.

**Does this game format lend itself to the console hardware, is that what you're saying?**

Let's put it this way. The console hardware is such that we can implement that type of game as well – if not better – on the console than we can on the ST.

**Is that because of things like the hardware sprites?**

Yes. That's because the hardware sprites enable us to put more colours on. Also, although in this game we don't scroll the backgrounds. If we had gone to a scrolling design, obviously the console would have been able to handle that as well. We think it came out as well on the Amstrad as a product as it did on the ST. I think the thing you have to remember is we had hindsight as well. We were able to tweak any parts that we wanted to tweak because we'd already produced the ST version. But I wouldn't disagree with you. I think, up against the two, if I could play either one of them, I would probably be more likely to play the Amstrad console version.

*Well there you go – straight from the horse's mouth!*

*Er, no offence, James...)*



● *Switchblade*, technically, is done in the four-colour mode, but try counting the number in this screen shot! The programmers have used standard split-screen jiggery-pokery and the additional console hardware to 'cheat' on a grand scale.



THE COMPILATION PACK  
OF MEGA STARS

# HOLLYWOOD

Collection



GHOSTBUSTERS II



INDIANA JONES



ROBOCOP



BATMAN

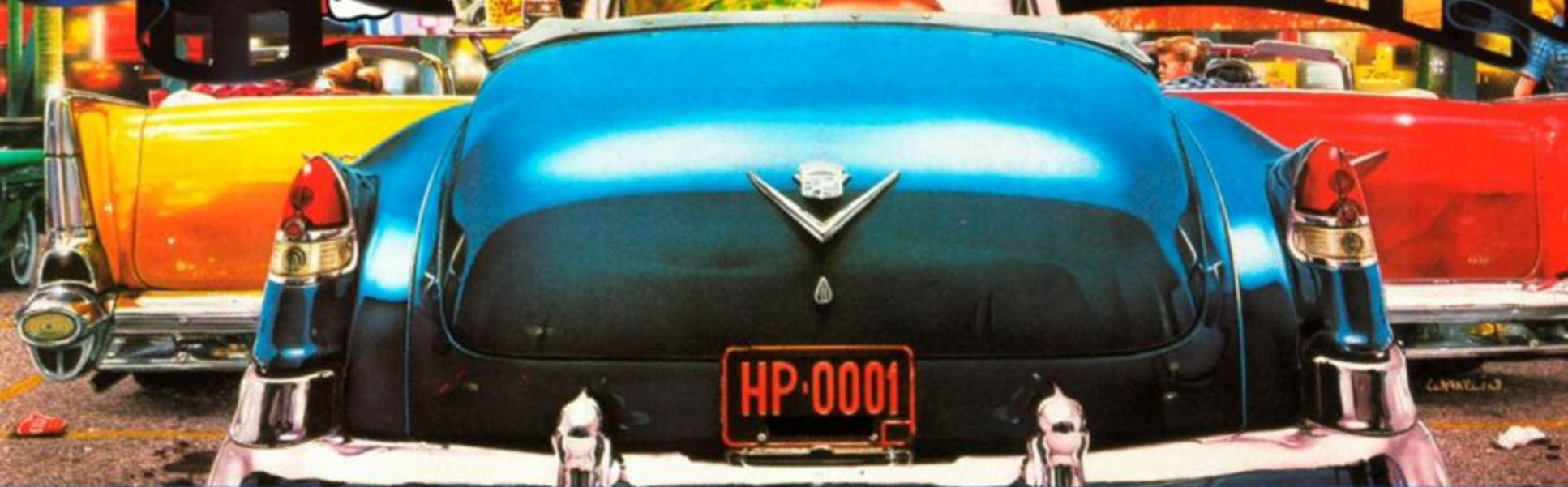

ROBOCOP

GHOSTBUSTERS II

INDIANA JONES

BATMAN



AMIGA ATARI ST

ocean

AMSTRAD  
SPECTRUM  
COMMODORE

OCEAN SOFTWARE LIMITED, 6 CENTRAL STREET, MANCHESTER, M2 5NS, TEL: 061 822 4422, FAX: 061 824 0611



# DISCOUNT SOFTWARE

from M.J.C. SUPPLIES

## DISC GAMES

MJC SPECIAL

### TEENAGE MUTANT HERO TURTLES

RRP £16.95 Our Price £11.95  
Offer runs from 1/01/91 to 31/01/91

Back to the Future 2	10.95
Bloodwych	10.95
Castle Master	10.95
Dan Dare 3	10.95
Dragons of Flame	14.95
Edition 1 Compilation	17.95
E-Motion	10.95
Golden Axe	10.95
Hammerfist	10.95
Hollywood Collection	14.95
Klax	10.95
Lords of Chaos	10.95
Midnight Resistance	10.95
Monty Pythons Flying Circus	10.95
Nightbreed Arcade	11.95
Night Hunter	10.95
Oriental Games	10.95
Pipe Mania	10.95
Rick Dangerous 2	10.95
Rainbow Islands	10.95
Shadow of the Beast	12.95
Sim City	12.95
Stunt Car Racer	10.95
Time Machine	10.95
T.N.T. Compilation	17.95
Turrican	10.95
Tusker	10.95
Twin World	10.95
Wheels of Fire Compilation	17.95

## EDUCATIONAL

Learn to Read with Prof (4-9)	14.95
CL Primary Maths Course (3-12)	14.95
Answerback Junior Quiz	11.95
Factfiles (require Answerback Quiz)	
Arithmetic (6 to 11 years)	7.95
Spelling (6-11)	7.95
Sports (12-adult)	7.95
Fun School 1 10 programs per disc	
For 2 to 5 years	6.95
For 5 to 7 years	6.95
For 8 to 12 years	6.95
Fun School 2 8 programs per disc	
For 2 to 6 years	8.95
For 6 to 8 years	8.95
For 8 to 12 years	8.95
French Mistress 12 to adult	15.95
German Master	15.95
Spanish Tutor	15.95
Italian Tutor	15.95
CASSETTE BASED	
Mini Office 2	9.95
Maxam 464	15.95
Protext 464	15.95
Tasword 464	15.95
French Mistress	12.95
German Master	12.95
Italian Tutor	12.95
Spanish Tutor	12.95
Answerback Junior Quiz	7.95

## DISC SERIOUS

Protext	17.95
Prospell	16.95
Promerge	16.95
Tasword 6128	23.95
Tasword 464-disc (464/664)	23.95
Taspell	14.95
Tasprint	11.95
Tascopy	11.95
Tasdiary	11.95
TasSign (6128)	23.95
Qualitas Plus v2	14.95
Qualitas Font Library	11.95
Qualitas CPM+ disc	8.95
MiraPrint (24 pin Qualitas)	19.95
MiraCopy (24 pin screen dump)	14.95
Masterfile 3 (Database)	29.95
Mastercalc 128 (Spreadsheet)	25.95
Matrix (Spreadsheet)	29.95
Stockmarket (share analysis)	25.95
Money Manager (home accounts)	21.95
Stop Press Desktop Publisher	34.95
Extra! Extra!	19.95
X-Press v2.0	18.95
Sprites Alive!	17.95
Sprites Alive! Compiler	22.95
Maxam Assembler	18.95
Mini Office 2	13.95
Advanced Art Studio	19.95
ColourDump 2	12.95

## CPM BASED

Protext CPM (inc Spell & Merge)	39.95
At Last Plus	29.95

Supercalc 2, special price.....£39.95

Arnor C Compiler	35.95
Hisoft C Compiler	35.95
Maxam 2	35.95
Hisoft Devpac 80 version 2	35.95
Nevada Fortran Compiler	35.95
Nevada Cobol Compiler	35.95
Hisoft Pascal 80	35.95
Iankey Crash Course	18.95
Iankey Two Finger Typing	18.95

CF2 DISCS  
Maxell: 5 for £11.00  
10 for £19.95  
Amssoft: 5 for £12.00  
10 for £21.95

## ROM BASED

Protext	27.95
Prospell	22.95
Promerge Plus	22.95
Maxam	27.95
Maxam 1.5 (needs Protext ROM)	20.95
Utopia	20.95
BCPL	21.95
Rombo (if ordered with ROM)	28.95

ALL ABOVE PRICES INCLUDE VAT, POSTAGE & PACKING IN THE U.K.  
THE ABOVE SOFTWARE IS ONLY FOR THE AMSTRAD CPC RANGE

## ACCESSORIES

Mastering Machine Code Book	8.95
Programming the Z80 book	23.95
DKT 64K Memory Expansion	45.95
Multiface 2 Plus	39.95
KDS 8 bit Printer Port	18.95
CPC-Centronics Printer Lead	9.95
464 Keyboard-Monitor Ext Lead	6.95
6128 Keyboard-Monitor Ext Lead	7.95
FD1 Disc Drive Lead (664/6128)	7.95
Monitor & Keyboard Dust Covers	7.95
(state Colour/Mono & 464/6128)	
3" disc drive head cleaner	6.95
Quickjoy 2 Turbo Joystick	9.95
Cheetah 125 Plus Joystick	7.95
Cruiser Joystick	9.95
Competition Pro 5000 Joystick	13.95
AMX Mouse & interface	34.95
Advanced Art Studio & Mouse	49.95
AMX Art software & Mouse	59.95
Stop Press & Mouse	64.95

## NEW 3.5" DISC DRIVES

Quality 3.5" disc drives enabling your CPC to use the cheap 3.5" discs in either standard 178k format or with Ramdos formats up to 800k can be used. The drives come complete with built in power supply, on/off switch, cable, and even a 3 pin plug. Suitable for all CPC's, although 464 owners must have a DD-1 before these drives can be used.

3.5" Disc Drive (complete)	79.95
Ramdos (big format software)	19.95
ROMdos (as above, with ROM)	24.95
10 3.5" blank discs	6.95
20 3.5" blank discs	13.00

## AMSTRAD 6128 PLUS COMPUTERS

Amstrads replacement for the CPC 6128 is now available.  
with Colour Monitor £399.95  
with Mono Monitor £319.95

## RIBBONS

Printer	Quantity		
	1	2	5
DMP 2000/3250	3.00	5.50	12.95
Panasonic KXP1081	3.95	7.00	15.00
Citizen 120-D	3.95	7.00	15.00
Star LC-10 Black	3.95	7.00	15.00
Star LC24-10	4.95	9.00	18.00
Panasonic KXP-1124	5.95	11.00	---
Star LC-10 Colour	5.95	11.00	---
Star LC200 Mono	5.50	10.00	---
Star LC200 Colour	10.95	19.95	---
Star LC24-200 Mono	4.95	9.00	---
Heat Transfer Ribbons (for iron-on transfers)			
Citizen 120-D	10.95	19.95	
Panasonic KXP 1081	10.95	19.95	
Star LC-10 Black	10.95	19.95	
Star LC-10 Colour	16.95	29.95	

## Quali Pack V.2

The Print Enhancement Package  
Qualitas Plus V.2  
KDS 8 Bit Printer Port  
R.R.P £36.90  
Package Price £31.95  
Quali Pack Extra V.2  
Qualitas Plus V.2  
KDS 8-bit printer port  
Qualitas font library  
RRP £51.85 Our Price £41.50

## PRINT COLOUR GRAPHICS!

At last it is possible to get colour screen dumps from a 6128!  
ColourDump 2 is available exclusively from M.J.C Supplies. Will take a standard screen file from the Advanced Art Studio or created with AMX Art, and Prints out in full colour on a Star LC10 colour printer. Also works on Epson compatibles (inc. DMP 2000/2160) with coloured ribbons.  
Colour Dump 2 £12.95  
Advanced Art Studio £19.95  
Star LC-200 PRINTER £219.95

## PRINTERS

All prices include cable, ribbon, VAT, and postage and packing. Courier service available, add £5  
FEEL FREE TO CALL FOR ADVICE

## CITIZEN 120-D PLUS

A cheap Epson FX compatible, with a range of text styles and sizes in draft mode, limited in Near Letter Quality.  
£139.95

## PANASONIC KXP - 1081

Well built and very reliable, offers all the sizes and effects of the Citizen 120-D, but offers NLQ in all combinations.  
£159.95

## STAR LC-10 Mk 1

On a par with the Panasonic for build, speed and NLQ combinations, but offers 4 different NLQ styles and double height effect.  
Great value  
£169.95

## PANASONIC KXP-1180

Offers 4 NLQ fonts, and fast printing. A direct competitor for the old LC-10 mark 2  
£179.95

## STAR LC-200

The latest colour printer from Star. Not only very fast, but offers new paper handling features. Probably the best buy for Christmas  
£219.95

## STAR LC24-200

The replacement for the popular LC24-10, with the same 5 letter quality fonts, shadow and outline effects, and again, much quicker and with improved paper handling. Please call for advice if you require graphic output  
£269.95

## PANASONIC- KXP 1124

Excellent text quality, build quality, paper handling and control panel. Please call for advice if you require graphic output  
£259.95

PRICES INCLUDE VAT & POSTAGE TO THE U.K.

Education, Local Authority and Government orders welcomed.  
Overseas customers also welcome, please call or write for quotations.  
All goods subject to availability, all prices subject to change without notice. E&OE.

CALLERS WELCOME: 9.30 TO 5.00, SIX DAYS.

# M.J.C. SUPPLIES, (AA)

2, THE ARCHES, ICKNIELD WAY, LETCHWORTH, HERTS, SG6 1UJ  
TELEPHONE ORDERS AND ENQUIRIES  
LEITCHWORTH (0462) 48.11.66 ( 6 lines) FAX: (0462) 670301

Prop. M.J. Cooper

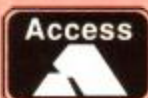

EUROCARD





# GRAND PRIX CIRCUIT

Accolade • £9.99 cass, £14.99 disk  
joystick/keys

# GRAND PRIX CIRCUIT™

CODED BY RANDOM ACCESS  
VISUALS BY CHRIS LOME



COPYRIGHT © 1989/90 ACCOLADE INC.

It's the ultimate circus. From March to November each year, the great Grand Prix show visits about twenty cities worldwide. Each city is host to an exhilarating battle of reactions, courage and nerve. There are always exultant winners, sad losers and bad accidents.

So many games have been written about motor racing that new ones are no longer seized on with glee. In short, a game following the same format as all the others would have to be something pretty special to get itself noticed.

*Grand Prix Circuit* from Accolade sets out to simulate the Drivers' Championship. There are ten drivers, of which you are one. Your first job is to select the car you wish to guide around the circuits. It's a tactical decision. You could opt for the Ferrari which, although not the fastest, sticks to the road like glue around

your way, and you have an automatic gear-shift. In fact, things couldn't really be easier. Skill levels three and above force you to change gear yourself. How uncouth. The drivers are also progressively better, and the damage your car takes by sallying onto the verges is worse.

You can have just one race against other drivers (on the circuit of your choice), you can enter the championship, or just practise.

Every time you race against competitors, you must first drive a qualifying lap. This is theoretically intended to give you a grid position. However, it is incredibly difficult to end up in any position other than last. This is almost certainly an oversight by the programmers; the other cars' qualification times are just too fast. Another problem with the qualifying laps is that they are compulsory. It would be nice to be able to leap-frog them and get straight down to the competitive high-jinks. Even if this option were to automatically give you last place, it would be preferable to motoring round alone for a few minutes, knowing that you'll be in last place anyway.



● First place. Keep your clog down.



● Choose the part of the World you wish to visit!

The races themselves can be any length you want. On Easy level it's possible to win stormingly in the McLaren simply by driving on the grass past the pack in the first few seconds of the game. Thus each race can be only one lap long, and you'll have 160 points after eight races.

If you do win the championship, mind, you'll get nothing in the way of a prize or recognition. The game simply starts over again. This is seriously depressing for anyone who has struggled legitimately to reach this position.

The graphics, the most important part of a game like this, are not up to par. They show the road ahead, other cars and nice scenery, but they are far too slow. The digital speedo tells you you're doing 230 mph, but it doesn't feel like any speed at all.

The other cars are drawn well. But you only ever see one or two, and those from rear view. Overtaking is a joke. If you head straight for a car the computer will often tell you that you've

passed it successfully. But if you head for a gap your damage increases and your speed drops, indicating that you've hit someone.

It is these two factors which really let down *Grand Prix Circuit*. The fun should be in racing nine

other cars around a fast and frantic course. However, the action is neither fast nor frantic, and the other cars only serve to annoy you with their illogical behaviour and the poor collision detection. Otherwise, it might even have been possible to live with the fact that you have to do a qualifying lap before every race,

## SECOND OPINION

*"Rather a disappointment, alas. I'm a huge Grand Prix fan, so I was expecting many hours of fun. Putting in the practice would be no problem if only the game was worth the long-term effort. As it is, it's just too slow." RL*

and also the fact that you face the same buildings and scenery every race. Incidentally, there is one building which, no matter which corners you go round, is always in front of you... You get tired of seeing it after a while.

The sound is fine (especially if you like whining engine noises), the car's responsiveness is OK, and there is some nice attention to detail, such as the corner-displayed map of the circuit with all the positions of the cars. It's just the playability that let's it down. And that means everything.

James 'Hunty' Leach



● Last position? Simply go past on the grass!

the bends. The Williams is faster, but it'll slide around a bit at speed. And then there's the McLaren. This goes like a greased weasel. But close your eyes and hope whenever you encounter a slight curve in the circuit.

There are five difficulty levels. The easiest level ensures that you won't spin off, even in the McLaren. The other drivers try to get out of

**FIRST DAY TARGET SCORE**

Win the Championship on Easy level

### The Verdict

**GRAPHICS** ..... **62%**

- The 3D views work OK.
- But the graphics are so slow.

**SONICS** ..... **65%**

- Howling V12s is about all.

**GRAB FACTOR** ..... **67%**

- Not difficult to drive.

**STAYING POWER** .. **57%**

- You'll be cheesed off by always having to qualify, and by the antics of the other cars.

**AA RATING** ..... **63%**

- Even Satoro Nakajima is faster than this! (Grand Prix joke.)







# FOOTBALL CRAZY!



Somewhere there must be a die-hard core of people who never tire of playing football management games. It's more than likely these people live in secure buildings with soft walls and no sharp objects. But each to his own, we suppose. Just as long as we can't hear them screaming at night. Anyway, Cult has released a veritable feast for such people, as JAMES LEACH reveals...

## **SOCCER STAR**

Cult ● £2.99 cass keys

Just imagine! You've suddenly been handed a Fourth Division team to manage to the top of the First, whilst trying to capture the FA Cup in the process. You start off with a big lump of dosh and half a team. Buy and sell the lads to get the best team available, train them, then start the season.



your team is doing OK. When a shot at goal is taken the scene shifts to a 3D (ish) display of the pitch. The attacker is seen kicking towards



● The main menu. Yes! You are Bobby Robson!

the goal. The defenders might intercept, the goalie might catch it, or the striker might miss. All this depends on the three skill levels of the teams; the midfield levels decide whose end the fluctuating ball heads towards, and when the goal screen appears, the attacking level is pitted against the opponents' defending level.

NAME	TYPE	SKIL	FTH	STAB	TEAM
GOODISON					FL
GRAVE					FL
HALLING					FL
JONES					FL
MCCAFFEE					FL
HOPKINS					FL
BRADICK					FL
LEWIS					FL
MARR					FL
HARRIS					FL
BRENT					FL
PHILLIPS					FL
YOUNG					FL
GLOVER					FL
HAVIN					FL

RETURN : : : : :  
SQUAD : : : : :  
: UP : DOWN : SHAP : SUB :

● Pick your team using these player stats.

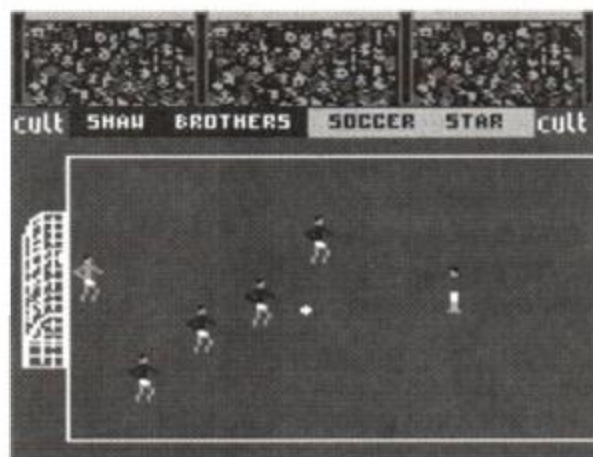

● Four defenders try and stop the York lad scoring.

A large amount of excitement can be generated by this simple system. The goalmouth action can have you shouting for your team out loud. What lets the game as a whole down is the level of interaction. There isn't much, really. You buy and sell likely bods at the beginning of the season, and then all you do is make occasional substitutions when injuries occur.

Overall, though, this is more fun than most management sims, purely because you can watch your team playing. It isn't a hard game, but can get quirky: even if you are at the top of the league, if you haven't got much money

you'll be sacked at the end of the season.

So, as long as you remain solvent and keep the team functioning, you should eventually rise to the top of the heap.



### FIRST DAY TARGET SCORE

Make it to the Third Division

### The Verdict

**GRAPHICS** .....60%  
 Simple, but a definite bonus in a management sim.

**SONICS** .....55%  
 Cheers from the crowd, mainly.

**GRAB FACTOR** .....61%  
 Idiot-proof and easy to get into.

**STAYING POWER**...54%  
 Exciting to watch, but gameplay is limited.

**AA RATING** .....57%

A curious hybrid. Neither part really works well on its own, but together they are a lot of fun.



# CUP FOOTBALL

Cult ● £2.99 cass keys

Cup Football sets its sights on greater goals. European goals, to be precise. It concerns itself solely with the UEFA Cup.

You choose a European team to guide into combat with some of the world's finest squads. You are allocated a group with four other teams, and you must play a mini-league with them to decide who goes on to the quarters, and semi-finals. Each of your players has a fit-



● The running commentary scrolls up the screen.

ness rating (which tends to drop with each game) and a skill rating. This can be improved for specific players by spending money on them. However the levels might not rise, or might even drop owing to over-training. So it's always wisest not to bother with this at all.

The game is played in speeded up time, with a basic commentary scrolling up the screen. Goal times and scorers are printed as



● What a team. Watch out Europe, here we come!

they occur, so if it's a close match, things get more and more tense as the final whistle approaches.

An added feature is the ability to place bets on the teams. It is really rather hit and miss, but at the beginning of the game your team is not worth betting on, so you may as well bet



● The menu gives you a fair degree of choice.

on the opposition. Just don't get caught doing this in real life (especially if you live in Swindon).

Cup Football has more features than many management sims, but doesn't have a really polished feel. It works OK, but the games themselves take a little too long to play, and there is no way of speeding things up. There is also a tele-printer feature, which churns out

## ACTION TEST



results like the one seen on Grandstand. It, as you will know if you've ever sat watching Grandstand waiting for Noel Edmonds' Saturday Roadshow, is not very fast either.

This effort apart, there are no graphics (or sound).



### FIRST DAY TARGET SCORE

Win through to the next round

### The Verdict

**GRAPHICS** .....0%

■ Only the vidi-printer (and that isn't graphics, really).

■ The character set hasn't even been redesigned.

**SONICS** .....0%

■ Nope. Not a sausage.

**GRAB FACTOR** .....42%

□ Playing in Europe is still a novelty!

**STAYING POWER** ...39%

■ Nothing really new here, though.

**AA RATING** .....40%

□ Standard sim with commentary and vidi-printer.

# THE FOOTBALLER

Cult ● £2.99 cass keys

You just can't beat the cut and thrust of the English League. Starting at the bottom of Division Four, you must fight your way to the top. It isn't easy, primarily because your team is rubbish. But by carefully bidding for players on the transfer market you should improve until you are not quite as bad, and start thrashing everyone.

There are no graphics or sound; this is a standard text-only management sim. It has some nice features, however, such as a minute counter when each game is playing. Goals are scored 'as they happen', so you'll be on the edge of your

NO.	SQUAD	POS	SAL	CLS	PLD
1	B. DRY	G	1000	1	0
2	J. ASHURST	D	1000	1	0
3	D. PENKIE	D	1000	1	0
4	J. PEARSON	D	1000	1	0
5	H. ASPIH	D	1000	1	0
6	J. SHERIDAN	M	1000	1	0
7	B. CRASSBY	M	1000	1	0
8	B. FAYLOR	M	1000	1	0
9	B. AILESCO	M	1000	1	0
10	G. STILES	M	1000	1	0
11	G. SHODIN	A	1000	1	0
12	B. ADAMS	A	1000	1	0
13	D. WILLIAMS	A	1000	1	0

● The Bath squad. Hopeless, really.

NO.	NAME	POS	SKILL
(1)	P. MURBY	M	2
BID OVER : £ 32754			
SWANSEA	: OFFERS	£ 34254	
EXETER	: OFFERS	£ 40743	
WALSALL	: OFFERS	£ 38213	
KARTLEPOOL	: OFFERS	£ 47286	
PLYMOUTH	: OFFERS	£ 33789	
BATH	: OFFERS	£ 30000	

● Careful buying and selling is the key.

seat until the very last minute.

Each player has a skill, fitness and ability value. These combine to give an overall figure for that player. The team is divided into defenders, midfield players and attackers. The totals of all the players in these categories are totted up to give the three strengths of the team. It is thus a simple mathematical process to work out which players to buy to improve your team. This takes away some of the fun; there aren't many other factors to affect the outcome.

One big niggle is the fact that all keypresses are stored in the buffer, to return and annoy you later. If you press the 'start game' button twice, two games are played in succession. And there's nothing you can do except snarl.

The balance of Footballer is tipped in your favour. If you keep playing, you tend to move to the top of each league. This adds to the feeling that it's just a matter of loading up and waiting until you win.



### FIRST DAY TARGET SCORE

Leave it playing until you win

### The Verdict

**GRAPHICS** .....0%

■ A seventies-computerish typeface is used.

**SONICS** .....0%

■ Like most games of this genre, there aren't any.

**GRAB FACTOR** .....46%

□ Quite friendly. Not complex or difficult.

**STAYING POWER** .41%

■ But it is limited in its enjoyment.

■ A little too biased to the human player.

**AA RATING** .....41%

□ Just another management simulation.





# QUATTRO COMBAT

Codemasters • £2.99 cass  
joystick/keys

It's dark. You walk cautiously through the underground tunnels, sword at the ready. Suddenly an orc appears – automatically the sword flashes in an arc, cleaving the hideous creature's skull in two. Then there's a brief haze as the body magically decomposes into nothingness...

...Seen from the cockpit, two bandits come in fast at six o'clock. The lead spits from the barrel of the machine gun, and one of the enemy bursts into a crimson ball of fire. The other manoeuvres itself onto your tail. You try every trick in the book, but you just can't shake it off. You're hit, your vision goes red...

...Now the enemy surrounds you, pinning you down with and lobbing grenades. You're only chance is to keep moving through the hostile jungle terrain... if you can just reach the jeep...

...But a thousand oriental warriors are coming at you from all sides. The death stars leave your hands at a frightening pace, mowing them down like flies. There's a stairwell somewhere around, taking you to another equally tortuous level of the temple. But where is it...?

...Just a minute, what's going on? The scenario's a bit mixed up, isn't it? Well, yes. That's because it's not one game, but four. Quattro Combat is a compilation of four previously released Codemasters games. They're linked together through one theme: violence. All of the games pit you against overwhelming odds, which you have to overcome by inflicting all manner of death and destruction.

At under 75 pence a game, it's difficult to see how anybody could be disappointed with this compilation. Although tied loosely together with the combat theme, the games are generically different enough to make them all worth playing in their own right. All are good too, being the cream of the crop from the Codies' back catalogue.

Combat will have something for everybody. Whether you're into fantasy, planes, ninjas or straightforward warfare, there's something here to suit. Sure, the games may not be state-of-the-art, but for three quid, you get four very decent games at a very decent price.

Adam Waring

## The Verdict

Death Stalker	81%
Arcade Flight Simulator	78%
SAS Combat	68%
Ninja Massacre	81%

**AA RATING 83%**

Four for the price of one. That's value for you!

## SAS Combat

It's a jungle out there. In *SAS Combat* your soldier is taking on all comers, with a smoking gun to greet them. The game is somewhat reminiscent of *Ikari Warriors*. Your trooper has to make his way through a scrolling landscape, gunning down bad guys and lobbing grenades. There are one or two bonuses scattered around the battlefield.

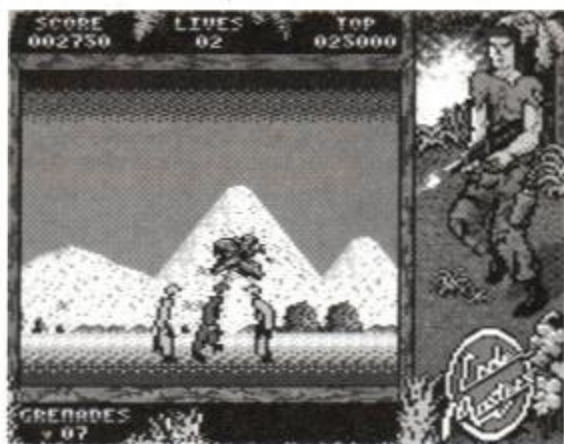

● You're surrounded in the stabbing section.

Picking these up gives you power-ups, the most useful of which is a jeep. In this, you're invulnerable against bullets, and only a grenade can kill you.

At first the game area scrolls from right to left, but at a certain point it switches to vertically scrolling.

As well as soldiers to slaughter, there are gun towers to contend with. On the upwards-scrolling section a train makes the

odd appearance. This can be destroyed for extra points.

On reaching the end of the level, play switches to a gun-less combat section. Here the viewpoint switches to side-on, and you have to get from left to right. This time the enemy cannot be avoided, and pinpoint accuracy is needed to knife them in the guts (ug! – ed). This part of the game contrasts heavily

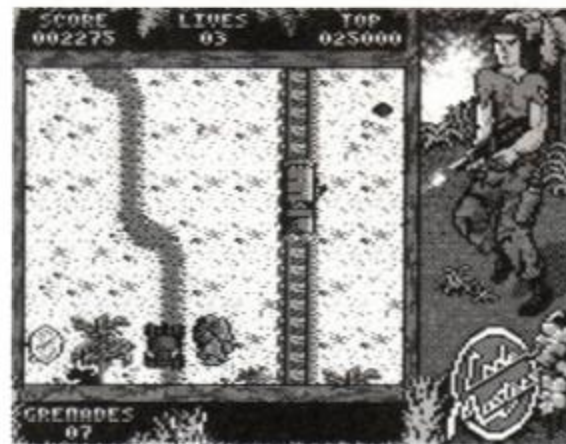

● The jeep offers good protection.

with the earlier section, which was too easy. This is frustratingly difficult. Stab your victim a second too early or a fraction too late, and you're dead.

The graphics are blocky, bold and bright throughout. *SAS Combat* is perhaps the weakest of the lot, but that's not to say it's a bad game. It falls just slightly short of the mark compared to the others in the collection.

## Ninja Massacre

*Ninja Massacre* is billed as a sort of oriental combat game. It's not a tiresome beat-em-up however, being more like *Gauntlet* than anything. One or two ninjas can join in the onslaught.

The game is huge. There are fifty levels, each several times the size of the on-screen area. There's plenty of variety, too. Some screens contain puzzles, some are mazes, and some consist of nothing more than mad, murderous mayhem!

The sprites are tiny, but there can be literally hundreds of them on-screen at once. The little chaps can move very quickly indeed at times. As they reach the edge of the screen, it scrolls, revealing more of the playing area. The maps are made from walls, doors and a variety of other features. On each level you have to

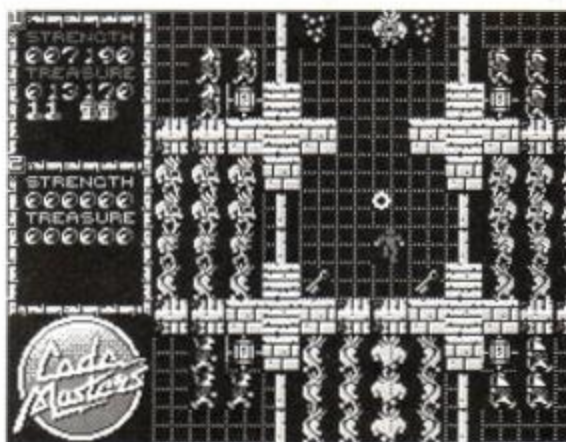

● How ever many you kill, they keep on coming!

find a stairway down to the next level. Sometimes it's quite straightforward to find this exit, but it can be more profitable to explore more of the level in the hunt for food to top up your rapidly-decreasing life counter.

As well as grub, there are many other collectables scattered around the levels. Treasure chests give you extra points. Keys allow you to unlock doors. Scrolls allow you to use a magic spell that obliterates all monsters and generates on screen when used. Other icons affect the way your bullets work, make the monster run away, or give you invulnerability for a short while.

With a single player it's quite a challenge but the fun really starts with two players. Here you can work either as a team, or against each other. You need to co-operate in some instances – the screen will only scroll so far, as it has to accommodate both players.

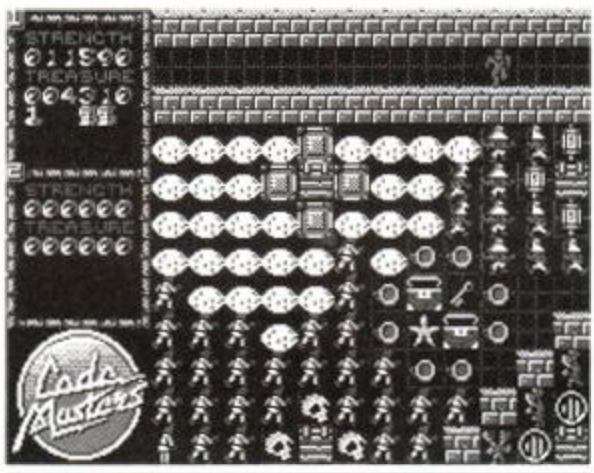

● Blimey! There's a lot of monsters and no mistake!





## Arcade Flight Simulator

*Arcade Flight Simulator* sees you in the cockpit of various warplanes spanning the three world wars (we're yet to have number three). In WWI you're flying early biplanes. WWII puts you in control of that ace of aces, the Spitfire. Things are up to date in WWII. Here you're in a modern jet fighter, complete with missiles.

There are three missions to complete, each in a plane of a different era. The first has you taking off from an airstrip from the green fields of England. You have to destroy shooting ten enemy planes out of the sky before returning to your airbase and picking up a bomb, and dropping it on top of the enemy camp.

Level Two has you taking off from an aircraft carrier. You have to do exactly the same thing as in the first level, though - pot ten planes, collect bomb, and blow the base.

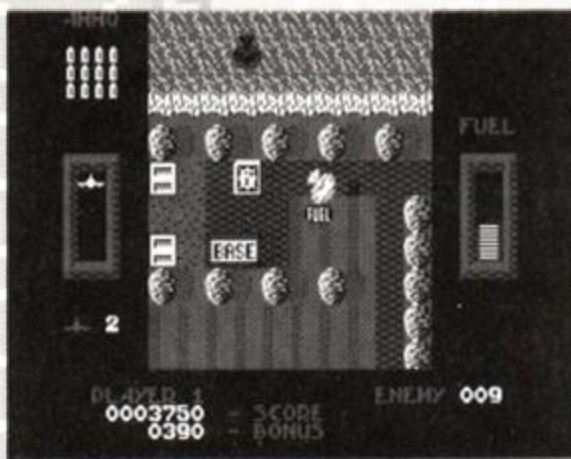

● That's the enemy base, but you can't bomb it 'til you pot all the planes.

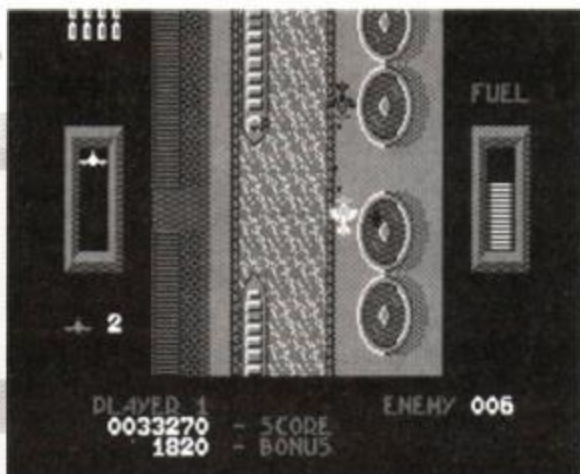

● Ack! Ack! Ack! Shoot 'em out the sky.

Level Three's jet fighter scenario is set in the desert (topical, eh?). Apart from that it's exactly the same plot with different sprites. It does get tougher as you progress; there are more enemies on screen at a time.

Fuel runs out quickly whatever you're flying, so you need to visit the fuel dumps that are scattered around. Flying low over them tops up your tanks. Bullets need replenishing too. For this you need to head back to base and land.

It's not easy to shoot down the planes. Not only do your bullets have a very short range, but the planes can fly at different heights, represented by the size and detail of the sprites. You have to be at their level to shoot them down, and, of course, they shoot back too!

Because of the nature of the game, the sprites are very small. At low heights they're little more than a tiny cluster of pixels. They do get more recognisable as they gain altitude, though. It can sometimes be hard to see exactly what's going on against

the background. Bullets are particularly difficult to spot, so a careful lookout is necessary.

Sound is good. The fx change with each type of plane. The early gunfire from the biplanes in the first level change to the rasp of machine guns in Level Two. This changes again to the swoosh of missiles when at the controls of the jets.

There is a two-player game which is very different from the single-player mode. There's no mission to complete and the screen doesn't scroll. The two planes re-enter the wrap-around screen on the opposite side when they fly off one edge.

It's a player on player dog-fight, and like most two-player games of this type, is extremely simple, but provides endless hours of entertainment.

*Arcade Flight Sim* is hardly that, but it's an excellent airborne blast nonetheless.

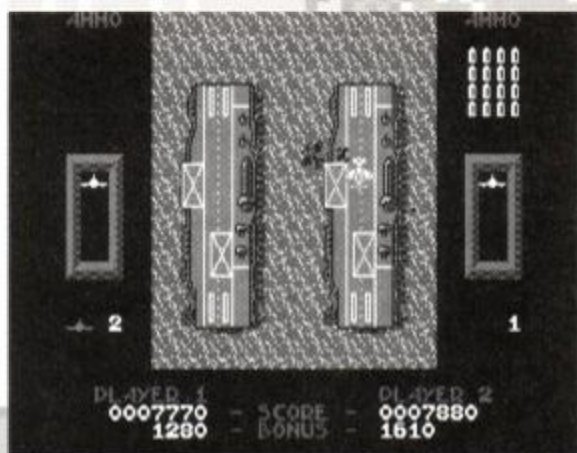

● Dog-fighting is great fun in two-player mode.

## Death Stalker

*Death Stalker* whisks you away to an ancient world filled with magic and monsters. Your warrior is (at first) equipped with a sword with which he can chop the orcs and undead skeletons to pieces.

The quest is to go down deep into the bowels of the earth and rescue several pris-



● Aarrgh! A pit trap means your days are over!

oners held captive, probably by some dark, evil figure. Rescue is attempted by the use of potions. You'll need one to free each prisoner, and you'll find them scattered around the mystical landscape. There are plenty of other objects to be found, too. Keys are important as they open up parts of the game hitherto unreachable. Food keeps you going - if it's

### SECOND OPINION

*"Startling value-for-money. With the possible exception of SAS Combat, all of these games are well worth £2.99 on their own, but in this compilation they'll set you back just 75p each!" RL*

not poisoned.

The graphics are wonderfully atmospheric. Up above ground, tall trees and towers make up the background. Enter the earth, and rocky caverns and rough-hewn passages are drawn brilliantly. Torches burn brightly on



● A prisoner! You could set him free, but if you're really nasty you can kill him instead!



● There's a couple of ghouls. Waste them before they waste

the wall, complete with flickery flames. Other things that flicker occasionally are the sprites... This is slightly annoying, but bearable.

The tune that accompanies the game adds even more to the atmosphere. It's very catchy and goes very well with the game indeed.

*Death Stalker* originally scored 72% back in AA41, it is the only game of the foursome that has been reviewed in AA before. The rating is probably a tad low for such a polished budget game, which explains why it's being given a whopping 81% this time round. Ah, nostalgia...





# BUMPY

Loricel ● £9.99 cass, £14.99 disk  
joystick/keys

Today you're a smiling-faced bouncy ball. Unarmed and totally harmless, your little task is to bounce yourself around a succession of screens, collecting points as well as many other useful, er, things (such as hammers, bananas, cream buns and droplets of water).

The first thing to do is to work out how to move. Normally, your little ball (aka Bumpy) isn't very bouncy at all. He wobbles up and down with hardly the power to move about the screen. However, if you press the Fire button, you can jump as high as you want. This facility is, as you'll soon find out, remarkably useful.

The idea is to move from platform to platform, collecting all the items which appear. These items give you special properties, such as the ability to knock down certain walls or put out the fires which occupy some of the

## SECOND OPINION

"Bumpy is trying to be a cutie game - but it hasn't quite worked. The ingredients are all there - the little cute character, the puzzle-based screens. The gameplay is frustrating, however, and relies too much on the player not having made mistakes on the earlier levels." **AW**

platforms. When you've collected the required number of items, an exit point opens somewhere on the screen. You must bounce your rotund little self through this, and on to the next level.

What makes the game difficult are the numerous traps and tricks on each screen.

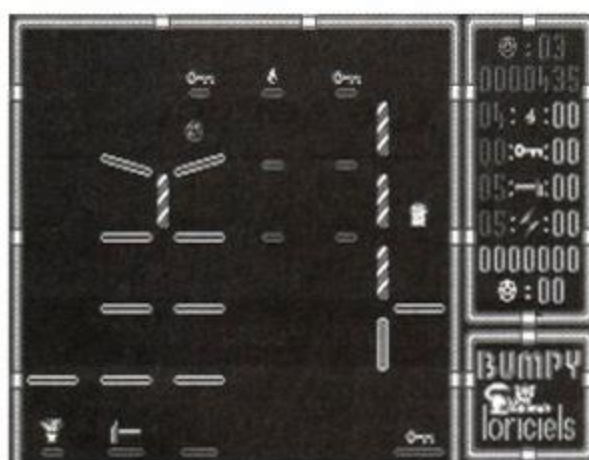

● Hit the tilted platforms and you'll bounce forever.

Some of the platforms melt when you bounce on them: others are tilted, so that when you land there, you are automatically sent in a pre-defined direction. You obviously have no control over where you end up. This is how some of the traps are set up; if you don't land on exactly the right platform, you can fall and be bounced between two angled platforms, which are facing each other, for ever. It must be said that this can get a tad annoying.

As you get through the screens, you keep all the collectables you've picked up. These

mustn't be wasted, because they'll definitely be needed on later screens. So it usually isn't worth leaving items lying around in order to get off a screen safely. Best to go and get them; they're sure to be very useful later.

Graphics are not very advanced. You are just a small smiling face, the platforms are just platforms and the collectables look like what they're supposed to be; little hammers, pieces of fruit and so on. To be honest, the game looks old. (But it does play better than it looks.)

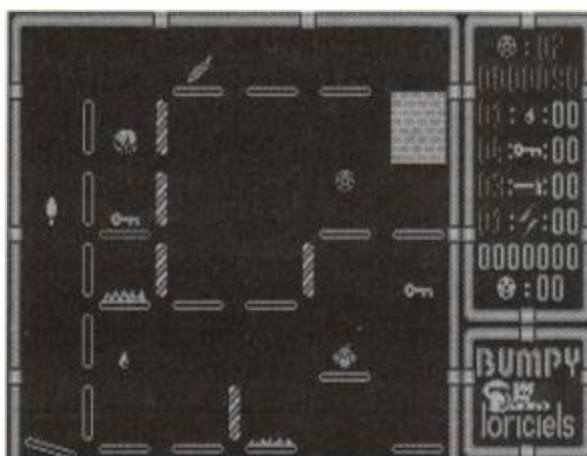

● Working out which way to go is always tough.

Sound is, like the graphics, simple. The obligatory bouncing sounds are provided, as are the bleeps when you die or pick up an item. This, plus an intro tune is the lot. There isn't much, but the effects don't feel too sparse.

Bumpy must guide himself through 100 lev-

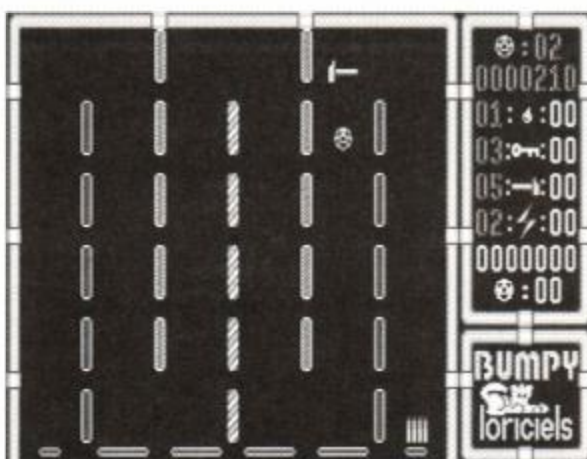

● Bumpy is bouncing his way towards the hammer.

els to complete the game. As if this wasn't enough, a level editor is included with the disk. This allows you to completely re-write all the levels. You can create screens which are as easy or difficult as you wish. It can be a lot of fun doing this, and you can save the results. However, it does get boring eventually, and you'll probably return to the screens that

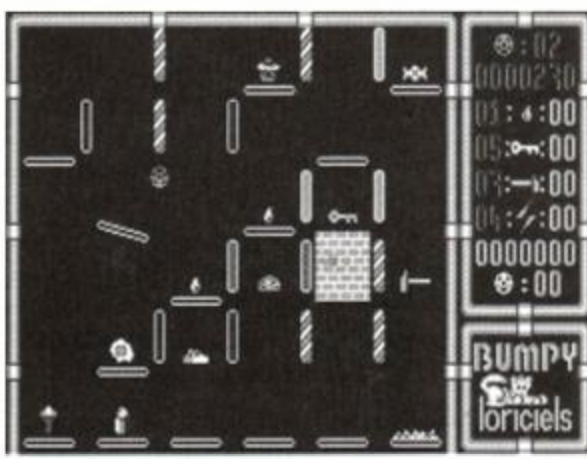

● A fiendish screen, filled with goodies to collect.

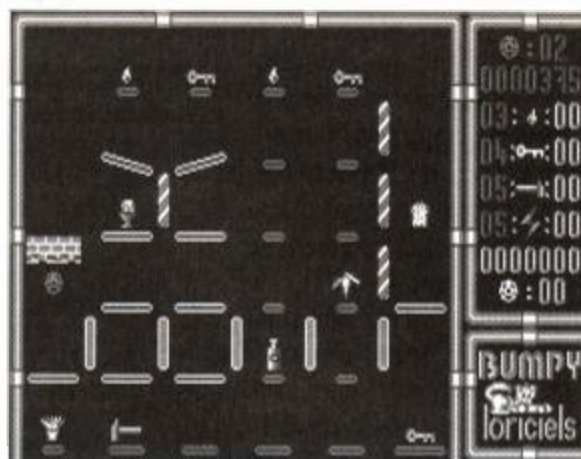

● Bumpy destroys a wall with his head. How cute!

Loricel has programmed. Some certainly are fiendish. You only have three lives, and if you lose the lot, you return to the beginning of the game, no matter how far you've progressed. It is virtually impossible to get through 100 screens of difficult bouncing with this few lives. It would have been better to give Bumpy a new set of lives every three or four levels. Instead, the apparent hopelessness of the task hardly inspires you.

Something else we should point out is that Bumpy wouldn't run on our new 6128 Plus. There would appear to be compatibility problems with some software, and you can be sure we'll keep you posted on this.

Bumpy is a nice idea, but when you look closely you realise that it is just a simplistic platform and jumping game. In comparison with the other excellent examples around, it almost starts to look like a budget game.

James 'Bouncy' Leach

## FIRST DAY TARGET SCORE

Get through five screens

## The Verdict

**GRAPHICS** .....52%

- Very simple.
- No complexity needed, though.

**SONICS** .....47%

- Bouncing sounds. Well, what would you expect?

**GRAB FACTOR** .....55%

- Nice idea. Quite a few interesting puzzles at first.
- There isn't a great deal of variety, though.

**STAYING POWER**...56%

- Not easy. The similar puzzles cause interest to flag.
- The editor function provides a neat option.

**AA RATING** .....54%

- Not bad, and editing your own screens is fun, but you'll tire of the whole thing far too soon.



# Serious Games

large scale strategy games for the Amstrad CPC6128

## SOCCER MANAGEMENT SIMULATOR

probably the most realistic football strategy game available for any home computer. Manage any of the 130 clubs in the English or Scottish leagues. All divisions have the correct number of teams and matches. 2 domestic cups and 3 European, with 100 foreign clubs, making over 3800 players to buy and sell. The manager can use any formation he wants and can tell his players where to pass. Also - save/load, can backup disc, record league results, accounts, youth squad, two substitutes, two-leg matches, intelligent opposition.

## IMPERIAL CONQUEST

a war / strategy game based in the ancient Mediterranean for one to five players. The year is 270 BC and Rome has just won overall control of Italy by defeating the Greek general Pyrrhus. This makes five nations with sufficient wealth, population, or national purpose to create a Mediterranean empire stretching from the shores of the Atlantic to the fringe of Asia, something even Alexander the Great could not achieve.

These five potential imperial powers are;

**Rome** - the youngest of the five, highly unified, quite wealthy, but with a fairly small population.

**Macedonia** - the birth place of Alexander. Now poor but still possessing a strong sense of nationhood, along with an undiminished hunger for conquest.

**The Seleucids** - the eastern remnants of Alexander's empire. Enormous population, great wealth but very little sense of purpose or national cohesion.

**The Ptolomaics** - the western remains of Alexander's conquests. Smaller population but more wealth than Seleucids, and slightly more national unity.

**Carthage** - the oldest of the five and the economic super-power of the Mediterranean.

There are also seven minor nations, which are either too disunited or too backward to pose a threat to the major powers but which can be useful in forming alliances or trading pacts.

The aim is to lead one of the five major nations and by means of war, trade, or politics create an empire that can survive in this violent world. Armies can be build from conscripts or mercenaries, and they can be transported to foreign parts by fleets. However war is costly unless victory is achieved quickly, so you may need to ally your nation with others before embarking on the path to imperial conquest.

Both games work only on the Amstrad CPC6128.

Both cost £15.00 including P/P. (Overseas add £3.00)

Cheques/postal orders payable to Serious Games.

Send to - Dept AA1, Serious Games, PO Box 6, Seaham, Co Durham, SR7 7EE

"As expected,  
a brilliant game..."



"...from Challenge!"

Trevor Brooking

## TREVOR BROOKING'S WORLD CUP GLORY



Exciting World Cup strategy  
on 5 skill levels with friendlies,  
qualifying group matches  
and the finals.

SPECTRUM 48/128K TAPE \$9.99  
COMMODORE 64/128K TAPE \$9.99  
AMSTRAD CPC464 TAPE \$9.99

SPECTRUM 48/128K DISC \$13.99  
AMSTRAD CPC664 & 6128 DISC \$13.99



NOW YOU'RE THINKING

Challenge Software, Hatton House, Church Lane,  
Cheshunt, Herts. EN8 0DW. Tel: 0992 640600

## PROTON SOFTWARE

Tel: 0462 686977 24 Hour. FAX 0462 673227



Cheques/PO's to: PROTON SOFTWARE, ENTERPRISE HOUSE,  
BLACKHORSE ROAD, LETCHWORTH, HERTS, SG6 1HL.

PACLAND disc £4.99	PACMANIA disc £4.99	MAN UTD cass £4.99 disc £8.99	SOCCER SPECTACULAR Cass £4.99
Please add 50p P&P if under £5	Phone now and place your order	New releases sent on day of release	Products in stock sent same day

Cass Disc

Cass Disc

Cass Disc

Adidas World Champion	Grand Prix.....6.99...9.99	Saint Dragon.....6.99...9.99
Football.....9.99	Gunship.....10.99.13.99	Satan.....6.99...9.99
Apprentice.....6.99...9.99	Hard Drivin.....6.99...10.99	Shadow of the
Back to the Future 2.....9.99	Heroes.....6.99...9.99	Beast.....8.99..11.99
Batman - Movie.....7.99..10.99	Hero's of Lance.....7.99..14.99	Shinobi.....6.99.....
Bloodwych.....6.99...9.99	Hollywood Collec. 9.99..16.99	Silkworm.....6.99.....
Brian Clough	Hostages.....6.99...9.99	Sim City.....6.99...9.99
Football.....6.99...9.99	Indy Jones Last	Sly Spy Secret
Cabal.....6.99..10.99	Crusade.....6.99...9.99	Agent.....6.99...9.99
Castle Master.....6.99...9.99	Internat. 3D Tennis6.99...9.99	Snowstrike.....7.99...9.99
Chase HQ.....6.99..10.99	Judge Dread.....6.99...9.99	Soccer Mania.....9.99.13.99
Chase HQ II.....7.99..10.99	Kenny Dalglish.....6.99..10.99	Strider.....6.99...9.99
Continental Circus.6.99..10.99	Kick Off.....7.99..10.99	Stunt Car Racer.....6.99...9.99
Country Cricket.....6.99...9.99	Kick Off 2.....6.99...9.99	Supersoft
Cricket Master.....6.99...9.99	Klax.....6.99...9.99	Road Racer.....7.99...9.99
Cyberball.....6.99...9.99	Lazer Squad.....7.99..10.99	Rick Dangerous II .6.99...9.99
Dan Dare 3.....6.99.....	Lords of Chaos.....6.99...9.99	Teenage Mutant
Days of Thunder...TBA...TBA	Lost Patrol.....6.99.....	Turtles.....8.99..11.99
Dick Tracy.....TBA...TBA	Microprose Soccer9.99..12.99	The Hit Squad.....6.99...9.99
Double Dragon II...6.99..10.99	Midnight Resistance6.99...9.99	The Nightbreed...TBA...TBA
Dragon Spirit.....6.99..10.99	Monty Python.....6.99...9.99	The Spy Who
Dragons of Flame .6.99...9.99	Narc.....6.99...9.99	Loved Me.....6.99...9.99
Dr Dooms Revenge6.99..10.99	New York Warriors6.99...9.99	Tie Break.....9.99..13.99
Dynamite Dux.....6.99..10.99	Ninja Remix.....6.99...9.99	Time Machine.....6.99...9.99
Dynasty Wars.....6.99...9.99	N/Z Story.....10.99	TNT.....9.99..16.99
Emlyn Hughes.....7.99..10.99	Operation Wolf.....7.99..10.99	Toobin.....6.99..10.99
Escape From the Planet of the	Op Thunderbolt.....7.99..10.99	Total Recall.....TBA...TBA
Robot Monsters.....6.99...8.99	P47.....6.99..10.99	Trivial Pursuit.....9.99..13.99
Fire & Forget II.....TBA...TBA	Pipemania.....6.99...9.99	Turbo Outrun.....6.99..10.99
Flimbo's Quest.....6.99.....	Platinum.....10.99.13.99	Turrican.....6.99...9.99
Football Manager II.4.99...9.99	Puzznic.....TBA...TBA	Tusker.....6.99..10.99
Funschool 3.....6.99...9.99	Rainbow Islands..7.99..10.99	Twin World.....6.99...9.99
Gazza's Soccer.....7.99..10.99	Rick Dangerous II .6.99...9.99	Wheels of Fire.....9.99..16.99
Ghostbusters II.....7.99..10.99	Robocop.....7.99..10.99	Xenophobe.....6.99...9.99
Golden Axe.....6.99...9.99	Robocop II.....7.99..10.99	



# K & M COMPUTERS

★ ★ FAST ★ ★ FRIENDLY SERVICE ★ ★

ADVENTURE	CASS	DISC
Gnome Ranger.....	£9.90	
Mindfighter.....		£5.90

## COMPILATIONS

Cecco Collection.....	£9.90	£13.90
Heroes.....	£11.75	£14.90
100% Dynamite.....	£11.75	
The Biz.....	£11.75	
Megamix.....	£11.75	
Edition 1.....	£9.90	£17.75
In Crowd.....	£11.75	
Mindstretchers.....	£13.90	£13.90
Platinum.....	£11.75	£14.90
T.N.T.....	£11.75	£17.75
Wheels of Fire.....	£11.75	£17.75
Hollywood Collection.....	£11.75	£14.90
Sega Master Mix.....	£12.75	£17.75

## STRATEGY / SIMULATION

Lords of Chaos.....	£7.75	£11.75
Battle of the Bulge.....	£8.75	£11.75
Oriental Games.....	£9.90	£14.90
Int. 3D Tennis.....	£7.75	£11.75
Pro. Tennis Tour.....	£7.75	£13.90
Dragons of Flame.....	£8.75	£13.90
Bloodwych.....	£7.75	£11.75
Sim City.....	£8.75	£12.90
Pirates (6128).....		£14.90
Gunship.....	£11.75	£14.90
Manchester United.....	£7.75	£11.75
Kick Off 2.....	£7.75	£11.75
Ancient Battles.....	£11.75	£11.75

## EDUCATIONAL

Answer Back Junior.....	£7.95	£11.95
Fun School 3 (U5, 5-7, 7+).....	£9.99	£12.99
Fun School 2 (U6, 6-8, 8+).....	£7.99	£9.99
Dragon World (6128).....		£20.95
Granny's Garden (6128).....		£16.95
Three Bears (6128).....		£13.90
Physics GCSE.....	£11.75	£14.95
Chemistry GCSE.....	£11.75	£14.95
Biology 1.....	£8.50	£12.95
Physics 1.....	£8.50	£12.95
Chemistry 1.....	£8.50	£12.95
Magic Maths (4-8).....	£8.50	£12.95
Maths Mania (8-12).....	£8.50	£12.95
Maxi Maths (Geometry 12+).....	£8.50	£12.95
Better Maths (12-16).....	£8.50	£12.95
Fun School 3 (U5, 5-7, 7+).....	£9.90	£12.90
Mankey Typing Tutor (6128).....		£19.90

ARCADE	CASS	DISC
Snowstrike.....	£8.75	£11.75
Stormlord 2.....	£8.75	£11.75
Batman the Movie.....	£7.75	£11.75
Outrun.....	£3.90	
Turrican.....	£7.75	£11.75
Dr. Dooms Revenge.....	£7.75	£11.75
X-Out.....	£7.75	£11.75
Barbarian 2.....	£3.90	
New York Warriors.....	£7.75	£11.75
Skate Wars.....		£11.75
Rainbow Island.....	£7.75	£11.75
Back to Future 2.....	£8.75	£11.75
Rick Dangerous 2.....	£7.75	£11.75
Puffy's Saga.....	£7.75	£11.75
Stunt Car Racer.....	£7.75	£11.75
Dragon Ninja.....	£7.75	£11.75
Elite.....	£3.90	
Ninja Turtles.....	£10.75	£13.90
Super Off Road Racing.....	£8.75	£11.75
Twin World.....	£7.75	£11.75
Bad Lands.....	£7.75	£11.75
ST Dragon.....	£8.75	£11.75
Golden Axe.....	£8.75	£11.75
Midnight Resistance.....	£7.75	£11.75
Night Breed.....	£8.75	£12.75
Monty Python.....	£7.75	£11.75
North & South.....	£10.75	£13.90
Spy Who Loved Me.....	£7.75	£11.75
Dragon Breed.....	£7.75	£11.75
Shadow of the Beast.....	£10.75	£12.75

## COMING SOON

The following games were not released at 21.11.90 but are due soon. Please phone for availability and other new releases.

Total Recall.....		PHONE
Iron Lord.....		£14.90
Sly Spy.....	£7.75	£11.75
Satan.....	£7.75	£11.75
Mystical.....		PHONE
Stun Runner.....	PHONE	

## BUDGET CASS. £2.50 EACH

Double Dragon	3D Pinball
Quatro Superhits	Sidearms
Salamander	Predator
Live & Let Die	Silk Worm
Dizzy Collection	Matchpoint
Target Renegade	Cobra
Tr. Island Dizzy	Avenger
Supertrux	Fast Food
Quatro Adventure	R-Type
Question of Sport	Kwik Snak Dizzy
Blazing Thunder	Yogi Bear III
Monsters	

AMSTRAD GX4000  
CONSOLE £97.00

Cartridges - £23.50  
Robocop II, Chase HQ II,  
Shadow Warrior, Batman, Operation,  
Barbarian, Double Dragon

NOW IN STOCK  
PHONE FOR LATEST  
CARTRIDGES

## KDS Electronics Special Offers

Rombox.....	£25.95
8 Bit Printer Port.....	£19.95
Serial Interface.....	£45.95
Ramdos (Disc).....	£24.95
Romdos (Eprom).....	£28.95

Mini Office 2  
Cass £11.90 Disc £14.90

SPECIAL OFFER  
Amstrad Joystick with 17  
games on disc (inc. Trivial  
Pursuit) £24.95

## Amsoft/Maxell 3" Discs

One.....	£2.50
Five.....	£12.00
Ten.....	£21.00

## 3.5" BULK DISCS ONLY 40p EACH

## Arnor Products

	DISC	EPROM
Protext.....	£19.90	£29.90
Promerge.....	£19.90	
Promerge +.....		£24.90
Prospell.....	£19.90	£24.90
Maxam.....	£19.90	£29.90
Maxam 1.5.....		£22.90
Utopia.....		£22.90

STOPPRESS £39.95  
AMX ART £59.95  
STOPPRESS & MOUSE  
£69.95

DMP 2000/2160/3160  
RIBBONS £3.00 EACH  
£5.50 FOR 2 - £13.00 FOR 5

OVERSEAS INC. EIRE  
PLEASE ADD £1.00 PER  
ITEM OF SOFTWARE.  
PAYMENT MUST BE IN  
STERLING

## ACCESSORIES

Rombox Rombox.....	£34.95
464 Keyboard Ext. Leads.....	£6.99
6128 K.Board Ext. Leads.....	£7.99
464 Cover Set Col/Mono.....	£8.00
6128 Cover Set Col/Mono.....	£8.00
DMP 2160/3160 Cover.....	£4.50
DDI-1/FD1 Dust Cover.....	£3.50
3" Drive Cleaner.....	£4.99
Multiface 2+.....	£44.95
Cassette Player & leads.....	£24.99
6128 Cassette leads.....	£3.50
Lockable 3" disc box.....	£8.99
AMS 30L Disc Box.....	£12.50
Printer Stand.....	£10.99
Ribbon Re-Ink.....	£12.95
Mouse Mats.....	£4.95
6128 Plus Exp. Adaptor.....	£14.95
Turntable Monitor Stand.....	£15.95
Printer Lead.....	£9.99
Computer Desks.....	£24.95

## BUSINESS/UTILITIES DISC

Advanced Art Studio.....	£19.99
Tasword 6128.....	£22.95
Masterfile 3.....	£32.95
Mastercalc 120.....	£20.95
Qualitas+ v.2.....	£13.90
Miraprint.....	£22.95
Miracopy.....	£11.95
Qualitas Font Pack.....	£13.95
Money Manager CPC.....	£24.95
Sprites Alive.....	£19.99
Sprites Alive Comp.....	£27.99

## HARDWARE

Star LC10 Printer.....	£179.00
Amiga Screen Gems.....	£379.00
Atari STFM Discovery.....	£285.00
Atari STE Power Pack.....	£379.00
FD1 Second Drive.....	£99.95

## JOYSTICKS

Jetfighter.....	£14.95
Superboard.....	£19.99
Ergostick.....	£17.75
Pro 5000.....	£13.95
Turbo 3.....	£9.99
Amstrad JY2.....	£9.99
Megaboard.....	£24.50

ALL ITEMS ARE  
SUBJECT TO  
AVAILABILITY

ALL PRICES INCLUDE VAT  
AND POST & PACKING  
ON ORDERS OVER £5  
UNDER £5 ADD £1 P&P

**K & M Computers (AA)**  
**140, Sandy Lane Centre**  
**Skelmersdale,**  
**Lancashire, WN8 8LH**

PHONE 0695 29046  
FAX 0695 50673  
24 HOURS

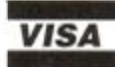

Prop. K. Fairhurst





# MAGIC LAND DIZZY

Codemasters ● £2.99 cass joystick/keys

Old Egg-head's back! *Magic Land Dizzy* is the fourth in the *Dizzy* trilogy. The games depict the adventures of a rather unlikely hero – a walking egg who wears boxing gloves. The *Dizzy* games are in the arcade adventure mould. A series of problems have to be solved to get further into the



● There's Dozy, but he's fast asleep.

game – just like a traditional adventure. However, it's not a case of typing in reams of boring text. Everything takes place in a graphical environment – it's a platform game in essence. The combination of the two requires accurate arcade skills and the ability to work out logical (and illogical) puzzles.

This time, Dizzy's old arch enemy, the evil wizard Zaks, is back with a vengeance! He was killed at the end of *Dizzy One*. Or was he? The truth is he has taken up residence in a



● The rat looks pretty hungry to me...



● Just how do you take the sword from the stone?

magic world, and is determined to take out revenge on our hapless hero.

The way he has done this is the way that will trouble Diz the most.

All Dizzy's friends have been taken hostage, and by magical means are trapped! Dylan has been turned into a tree. Denzil has been frozen. Dozy is in an enchanted sleep. Grand-Dizzy has been locked inside a magical mirror. Daisy has grown to the size of a house. Dora (a new character) has been turned into a frog! Dizzy has to rescue all the yolk folk and then kill the evil Zaks – this time for good!

Dizzy starts his quest at Weird Henge. At first, all directions seem closed. Wherever you may wander, the hazards seem to be impassable. After a bit of bold experimentation, and a lot of lost lives, however, you'll figure out how to get past some of those early puzzles.

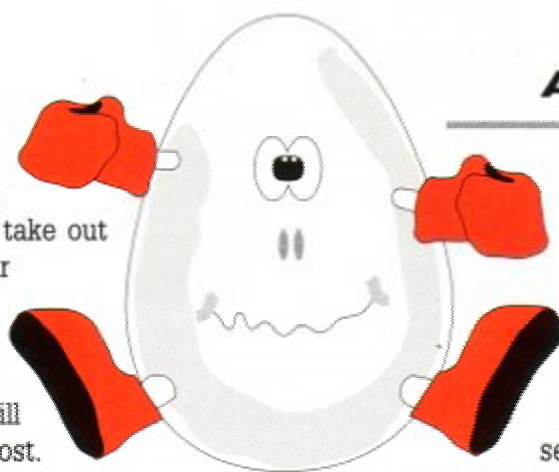

## DIZZY COMPILED

Before you rush down to the shops to get hold of *Dizzy* in time for Xmas, there's one thing you should know...

*Magic Land Dizzy* will initially only be available as part of a compilation. The *Dizzy Collection* includes five games starring our eggy friend, and will cost £9.95.

If you already have the rest of the games then you'll have to wait 'till after Christmas to buy *Dizzy IV* on its own. It will be released in the first week in January at the usual £2.99.

The usual array of brain-teasing puzzles are there to stop you. If anything, they're even more difficult than before – they certainly had the AA team stumped! The bizarre assortment of objects scattered liberally around magic land at first seem to have no relation to any of the puzzles. Then, all of a sudden like, you realise that maybe, just maybe, the thing you've been carrying around for ages could be the key to the puzzle that's been perplexing you for the last half hour. Then again, maybe not.

A couple of new features have been added, although for all intents and purposes the gameplay is exactly the same. Instead of collecting



● This puzzle's tough, but not impossible...

coins as a sideline, there are jewels for the taking instead. These are beneficial in more ways than just adding to your score – they boost your energy levels as well.

Graphics are once again four-colour Speccy ports. Dizzy himself is the only multi-coloured sprite.

All the other graphics are solid red, green or white. This colour coding does have a couple of advantages, though. It often gives clues to where it might be possible to make progress later on.

A jolly little tune plays throughout the game. It fits well into the cartoon nature of *Dizzy*, and ultimately becomes annoying. Then again, that's what volume controls are for!

## SECOND OPINION

*"It's a shame Dizzy IV is a Speccy port, but then again it's pretty well done, so perhaps we shouldn't complain. As with the other Dizzy adventures, this one's a little bit tough right from the start, but it will keep you going for a long time."*

RL

*Magic World Dizzy* will be welcomed by those who fell in love with the other three games in the series – after all, it's virtually the same. Not as many gameplay enhancements have been made to *Dizzy Four* as in previous efforts. Maybe there's only so much that can be done with the same old format...

The puzzles are certainly tougher, though, and should provide a challenge even to those who've completed all the other *Dizzy* games.

Adam Waring

### FIRST DAY TARGET SCORE

Rescue one of the Yolk Folk

## The Verdict

**GRAPHICS** ..... 67%

- As cute as ever.
- A Speccy port and no mistake.

**SONICS** ..... 62%

- Fitting, bouncy tune.
- A bit too jolly.

**GRAB FACTOR** ..... 88%

- Dizzy fans will be right at home.
- A bit tough at first.

**STAYING POWER** .. 83%

- You'll play and play and play...
- Until you complete it.

**AA RATING** ..... 85%

- Izzy Wizzy let's get Dizzy!





*Honey, I'll be back in a flash*

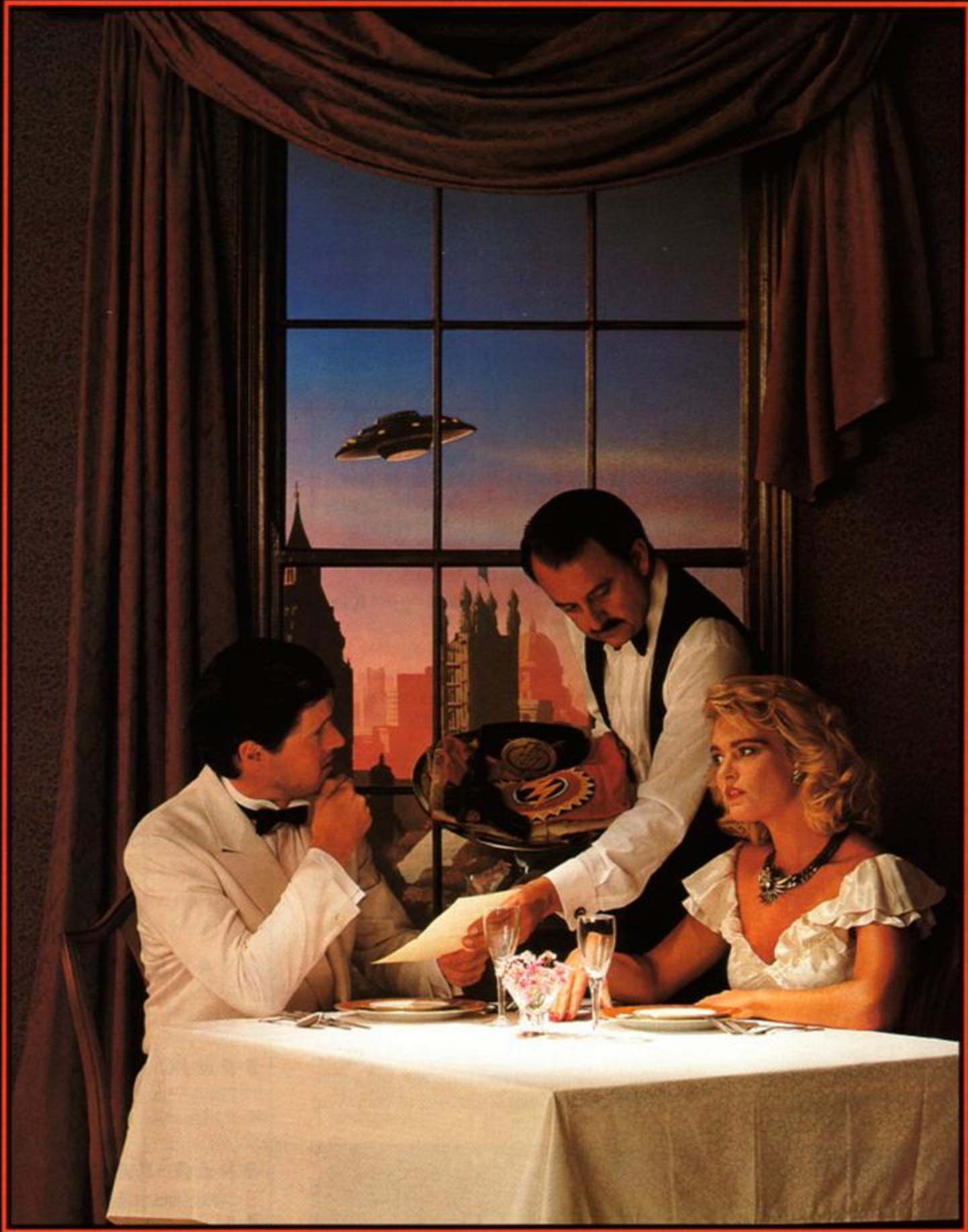

BACK IN A FLASH FOR COMMODORE 64, SPECTRUM, AMSTRAD,

**RICK DANGEROUS**  
**2**





*Keep it warm Honey!*

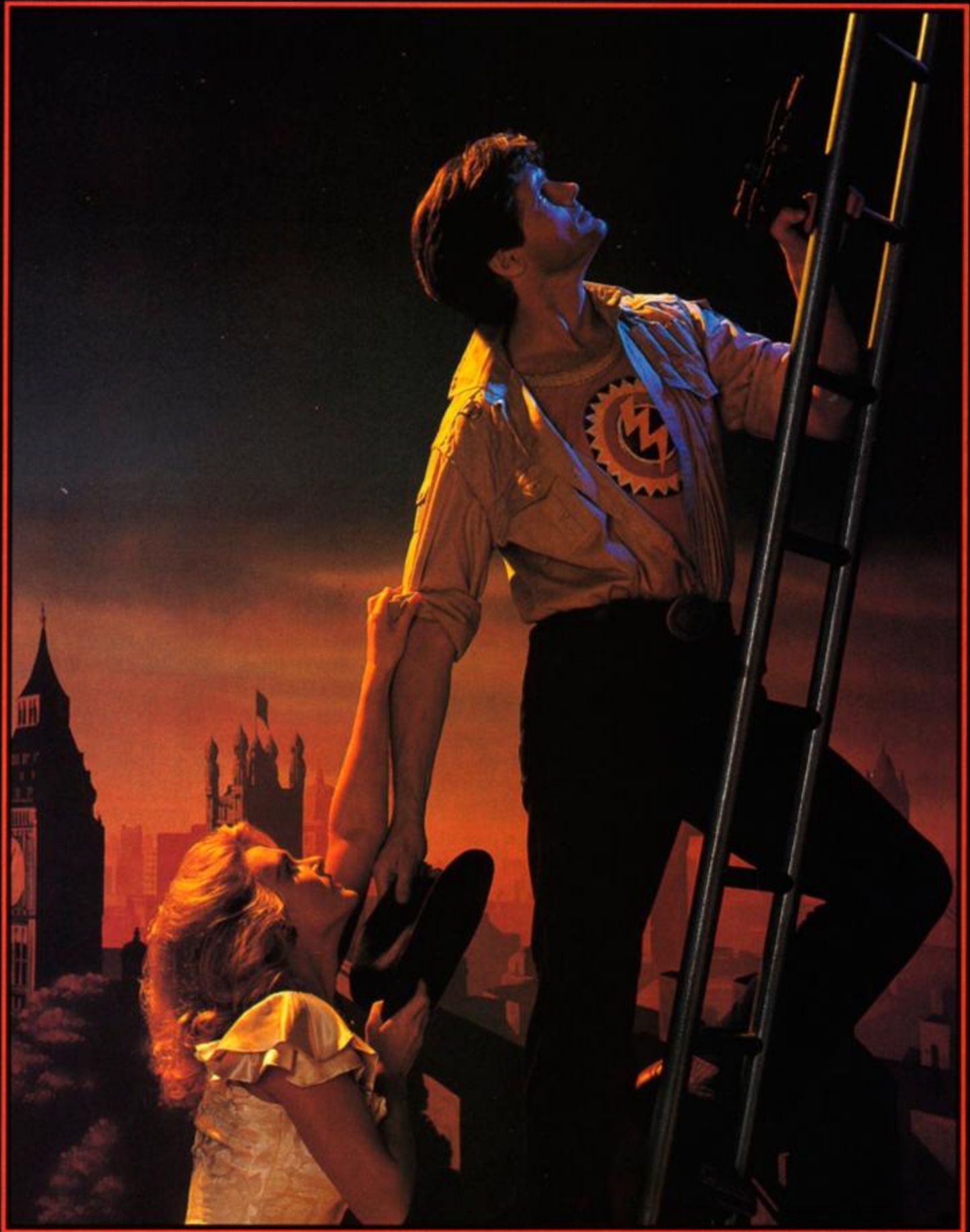

ATARI ST., COMMODORE AMIGA, TANDY AND IBM PC COMPATIBLES.

**RICK DANGEROUS**  
**2**





# THE SPY WHO LOVED ME

Domark ● £9.99 cass, £14.99 disk  
joystick/keys

Anyone seen a submarine around here? The British Navy has lost one, it seems. It's big, grey and full of men with beards. It must have rolled off the continental shelf and disappeared under the sea-bed. Oh well. It'll probably turn up soon, covered with fluff.

And anyway, we aren't the only people careless with their top-of-the-range nuclear powered ballistic subs; the Soviet Navy has also misplaced one. Hmm. This calls for unprecedented co-operation between East and West (this is pre-perestroika, remember).

## SECOND OPINION

'Spy Who Loved Me on the CPC looks almost as good as the 16-bit versions, which isn't saying much, unfortunately. It's pretty enough, nonetheless, but the awful control stops it assuming any real playability.' *RL*

The Russian have assigned gorgeous pouting Anya Amasova (translated, this means Helpless Female) to this tricky case. And the plucky Brits have sent James Bond. He suspects that the only evil, twisted mind capable of this large-scale theft of military undersea vessels belongs to Karl Stromberg. Consequently, Bond and Anya set off to visit this power-mad despot in his underwater fortress, Atlantis.

This is where you come in. You are now Bond, or rather Bonds' ageing Lotus Esprit. You must drive along a winding road with more traffic cones on it than the M25. The scenery is scrolling vertically past, and the course gets ever more tortuous. To add to the fun, other vehicles belt towards

you in the middle of the road. Avoid them, keep off the verges and send the cones flying.

Also littered around are large letter 'Q's. These must be driven over and collected. They can later be traded in for specialised equipment from Q's gadget workshop (assuming you get there). As well as all the other hazards, there are puddles on the road. Lotus's legendary handling appears to leave a lot to be desired as, every time you encounter a puddle the car spins out of control for a few seconds.

You'll eventually reach a pier. The car doesn't dive into the water like in the movie. It trundles to a halt and you both get into a small motor-boat.

The scrolling game continues. You chug off in the little boat. It is as hard to control as the car. But at least it is armed (albeit with a largely ineffectual missile launcher). You move the boat in exactly the same manner as the Lotus, and it responds the same way.



● James makes a tactical foray onto the verge.



● Rendezvous with the Q-Truck to buy equipment.

There are a great many piers and jetties to avoid. Some lead into blind alleys and cause you to explode horribly. The sea is littered with little buoys, other boats and more (waterproof) Q tokens to collect.

Once you have negotiated the hazards and headed out into the open sea, you are magically transported into the Lotus once more. It's with a sense of déjà vu that you begin driving along a vertically-scrolling road, avoiding cars and traffic cones and collecting Q points. The main difference is that this time you must rendezvous with the Q-Truck. Drive up into the back of it, and you can equip your car with a variety of weapons. Each costs a certain number of tokens. So that's what they're for...!

Having done this, you drive off again. This is the problem with *The Spy Who Loved Me*; there really isn't enough to do. The only difference with this driving section is that there are jumps to negotiate, pieces of broken glass in the road, and a helicopter buzzing overhead. This is packed with gun-waving baddies, and is just begging for a missile in the rotor-blades.

The third and final level (if you get there - yup, control is that tricky) has you belting off towards Stromberg's HQ and a final world-saving confrontation.



● Park on the jetty and climb into the boat.



● The puddles will send you spinning off.

The scrolling is pretty smooth, and there is a wealth of detail on the screen during the Lotus-driving sequence. What lets it down is the control. The car feels like it's driving on ice. And when you hit a puddle the control goes completely. The most successful way to get round the problem is to go very slowly indeed past the puddles. Yes, I know that Bond wouldn't be seen dead driving like an arthritic snail round a measly puddle. But the alternative is to crash.

Whenever you do lose life, you start either back at the beginning of the level, or at about half way through. Naturally, this is terrible news if you've struggled for ages and have almost got to the next level.

The sound is a bit sparse. There are no car or boat noises, but a scuffing can be heard when you drive off the road. Other effects occur when you hit things.

Overall, *The Spy Who Loved Me* isn't very fulfilling or satisfying. The link with the actual film is tenuous, and although the graphics are smooth and nicely drawn, they don't make up for the lack of gameplay.

James 'not Bond' Lea



● You have to ski-jump the boat.



## FIRST DAY TARGET SCORE

Get to the helicopter on Level Two

## The Verdict

**GRAPHICS** ..... 78%

- Smooth, detailed, colourful.
- The main sprite is a little small, though.

**SONICS** ..... 59%

- Not much, really.
- What there is fits in nicely.

**GRAB FACTOR** ..... 64%

- Initially challenging and addictive.

**STAYING POWER**... 41%

- It gets very monotonous.

**AA RATING** ..... 52%

- There isn't enough variety.



# RENT 'N' PLAY

**SEGA**  
MEGA DRIVE

**AMSTRAD**  
GX 4000

**Nintendo**

**Commodore**  
C 64 GS

**SEGA**  
MASTER SYSTEM

**CONSOLE CARTRIDGE HIRE FROM AS LITTLE AS £1.50 PER WEEK**

**OPERATION THUNDERBOLT..... £2.50**

**CHASE H.Q.2..... £2.50**

**KLAX..... £2.50**

**ROBOCOP 2..... £2.50**

**BATMAN THE MOVIE..... £2.50**

TITLES LISTED ABOVE REPRESENT ONLY A SMALL SAMPLE OF CARTRIDGES AVAILABLE FOR HIRE BY MAIL

FOR FULL LIST AND REGISTRATION APPLICATION SEND FORM TO:

RENT 'N' PLAY  
P.O. BOX 37  
BEESTON  
NOTTINGHAM  
NG9 1ED

NAME ..... AGE .....  
ADDRESS .....  
.....  
POST CODE .....

MY COMPUTER CONSOLE IS...

## RIBBONS

MADE IN THE UK BY **SWALLOW**

**Amstrad**  
PCW 8256 Fabric LONGLIFE 2741LL £4.95 Band C  
PCW 8256 Fabric colours \* 2741Col £4.95 Band C  
PCW 8256 Multistrike Films 2741MS £3.95 Band B  
PCW 9512 Fabric LONGLIFE 2746LL £4.95 Band C  
PCW 9512 Fabric colours \* 2746Col £4.95 Band C  
PCW 9512 Multistrike Films 2746MS £3.95 Band B  
DMP 2000/3000/3160 2482FN £2.95 Band A  
DMP 4000 2426FN £5.95 Band D  
LQ 3500 2741LL £4.95 Band C

**Others**  
Brother M1009/1109/1209 2412FN £4.95 Band C  
Commodore MPS-803 2412FN £4.95 Band C  
Canon PW1080A 2223FN £4.95 Band C  
Citizen 120D/180E/LSP-10 2488FN £3.95 Band B  
Citizen MSP-20/40/50 2477FN £4.95 Band C  
Citizen HQP-45 2478FN £6.95 Band E  
Citizen Swift 24 pin 2488DN £4.95 Band C  
Epson FX/MX/RX-80/LX-800 2273FN £3.95 Band B  
Epson LX/GX-80/LX-86/90 2454FN £4.95 Band C  
Epson LQ-400/500/800/850 2477FN £4.95 Band C  
Epson EX-800/1000 2774FN £4.95 Band C  
Epson MX/FX-100/1000/1050 2320FN £4.95 Band C  
Juki 6100 Daisywheel 2563MS £3.95 Band B  
Mann/Tally MT80/81 2698FN £4.95 Band C  
Mann/Tally MT85/87 2739FN £4.95 Band C  
Mann/Tally MT86/88 2740FN £5.95 Band D  
NEC Pinwriter P1/P2/P6 2254FN £4.95 Band C  
NEC Pinwriter P2+/P2200 2844FN £4.95 Band C  
NEC P6+/P7+ 2870FN £5.95 Band D  
Panasonic KXP 1081/1090 2228FN £4.95 Band C  
Panasonic KXP 1180 2905RD £4.95 Band C  
Panasonic KXP 1124 2904RD £4.95 Band C  
Seikosha GP 100 2317FN £3.95 Band B  
Seikosha SL 80/SP 1000/1200 2741FN £4.95 Band C  
Seikosha GP 500/550 2236FN £4.95 Band C  
Shinwa CP-80 2698MS £4.95 Band C  
Star LC-10/NX 1000 2861FN £3.95 Band B  
Star LC-10 4 colour 2861Col £5.95 Band D  
Star LC-24 10 2868FN £3.95 Band B  
Star NL-10 2761FN £4.95 Band C

★ **new! COLOURS** ★

CITIZEN 120D/180E/LSP-10 2488Col £4.95 Band C  
EPSON FX/MX-80 2273Col £4.95 Band C  
EPSON LX/GX-80/86/90 2454Col £4.95 Band C  
NEC P6+/P7+ 2870Col £6.95 Band E  
SEIKOSHA GP 500A/550A 2236Col £5.95 Band D  
STAR LC-10/NX 1000 2861Col £4.95 Band C  
STAR LC-24 10 2868Col £5.95 Band D

COLOURS AVAILABLE ARE - Blue/Brown/Red/Green

Buying more than one ?	2 - OFF	5 - OFF
Price Band A	£5.75	£12.95
Price Band B	£7.45	£16.95
Price Band C	£8.95	£19.95
Price Band D	£10.95	£22.95
Price Band E	£12.50	£27.80

cost effective computing starts here. . .

**CASPELL**  
**computer**  
order line ☎ **0202-666155**  
fax line: 0202 - 668208  
**PAPER**

BEST QUALITY white, wood free - LOW DUST specification

11x9.5"	60gsm FANFOLD LISTING	2000	£13.95
11x9.5"	70gsm MICROPERFORATED	2000	£15.95
11x9.5"	85gsm LETTER QUALITY	1000	£10.95
A4 size	70gsm MICROPERFORATED	2000	£19.95
A4 size	85gsm LETTER QUALITY	1000	£11.95
11x9.5"	NCR 2-PART PLAIN	1000	£21.95
11x9.5"	NCR 3-PART PLAIN	700	£24.95

...and of course there's our own UNIQUE A5 continuous paper  
A5 size 80gsm LETTER QUALITY 1000 £11.95

CARRIAGE:- PLEASE ADD £5.00 TO ANY ORDER FOR PAPER

## DISKS

branded quality  
**BENCHMARK - SENTINEL "Need we say more!"**  
Superior disk for all applications - we use these ourselves  
★ High clip level and high magnetic coercivity  
★ High performance with reliability

<b>5.25" DS/DD</b>	<b>HD 1.2MB</b>
25 for just £13.95	10 for just £11.95
50 for just £24.95	25 for just £24.95
100 for just £47.95	50 for just £47.95

<b>3.5" DS/DD</b>	<b>HD 1.44MB</b>
10 for just £11.95	10 for just £23.00
25 for just £24.95	25 for just £47.95
50 for just £47.95	50 for just £89.95

...and for the AMSTRAD CPC:

**3" maxell CF2** suits all 3.5" drives, single or double density  
The very best HIGH GRADE disks

5 for just £11.50	10 for just £21.95
20 for just £43.90 plus FREE...	

LOCKABLE DISK BANK (holds 20+) WORTH £9.95

## HOW TO ORDER

order by FREEPOST . . . or in PERSON  
CASPELL COMPUTER OPEN 9 to 5pm MON/SAT  
Dept AA Unit 2A  
FREEPOST Sterte Industrial Est  
Poole Sterte Road  
Dorset BH15 2BR POOLE Dorset  
☎ 0202 - 666155 BH15 2AF  
4 lines - 24 hrs

## Introducing Re-ink

FABRIC RIBBON RE-INKING FORMULA



Here it is . . . new Re-ink  
an OFFICE 21 product  
for the 1990's

ONE CAN WILL Re-ink UP TO 100 RIBBONS

Completely ozone friendly  
contains NO propellants or  
harmful solvents.  
Recyclable aluminium can.

All fabric ribbon cassettes have lift off top  
Just lift off the top, spray a little ink and  
leave to dry. CLEAN, CLEAR BLACK PRINT  
again and again and again . . .

**ACCESSORIES**

RIBBON REFRESH still only. . . £8.95  
Fanfold LABELS from **AVERY**  
Standard address size available 1 or 2 across  
3.5" x 1.5" . . . £3.75 per 1000  
many other sizes stocked - please enquire  
CARRIAGE:- PLEASE ADD £2.50 TO ANY ORDER FOR LABELS

**ALL OUR PRICES INCLUDE V**  
same day despatch + 1st class delivery  
ALL ITEMS FREE DELIVERY except Paper and Labels

DELIVERY UK MAINLAND	PAPER + ENVELOPES	LABELS	EVERYTHING ELSE
3/5 DAY SERVICE	£5.00	£2.50	£ FREE
NEXT DAY SERVICE (orders placed by 3:00pm)	£10.00	£10.00	£10.00
PERSONAL CALLERS			OVERSEAS (optional insurance)
Free of Charge (of course!)			Surface shipping at cost
COMPUTER ACCESS			POSTAL OFFICE

If your ribbon is not listed - please enquire





# MIDNIGHT RESISTANCE

Ocean ● £10.99 cass, £14.99 disk  
joystick/keys

When your entire family (including Grandpa, the eminent scientist) have been captured by a ruthless gang of international terrorists, there's just one thing for it. Peace talks through a United Nations envoy? We think not. The only way to negotiate with people like this is with a smoking Kalashnikov.

Your mission is to move in, and move them out. If you don't, the terrorists will force Gramps to build a big bomb and blow up the world (or arrange something equally catastrophic).

You're on your own from here on in, (the arcade version had a two-brother mode), and have to make your way through the hordes of

mechanised megalomaniacs with only a gun for company.

*Midnight Resistance* is a walk-along-the-platforms-and-shoot-everything-that-moves type of game. The difference is that the ways in that you can make your enemies die horrible deaths are far more varied than in other games of the genre. For a start, your weapon can spit lead through a full 360 degrees. It's also possible to crawl through tight passages, still spraying this circle of death as you go. Baddies



● Hitch a ride on the jeep at the start of Level One.



● Take out that laser tower before making progress.

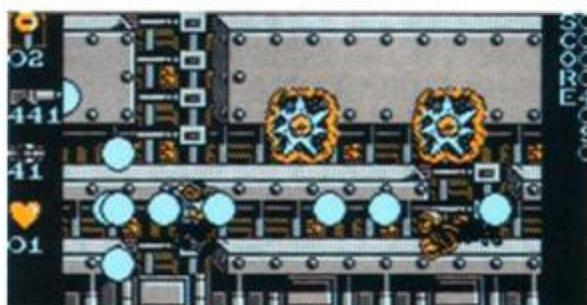

● The power-ups give you some serious firepower.

## THE WEAPONS SHOP

(End of Level One)

Here you can use all those keys you've collected to upgrade your firepower. The number of keyholes tells you how many keys you'll need.

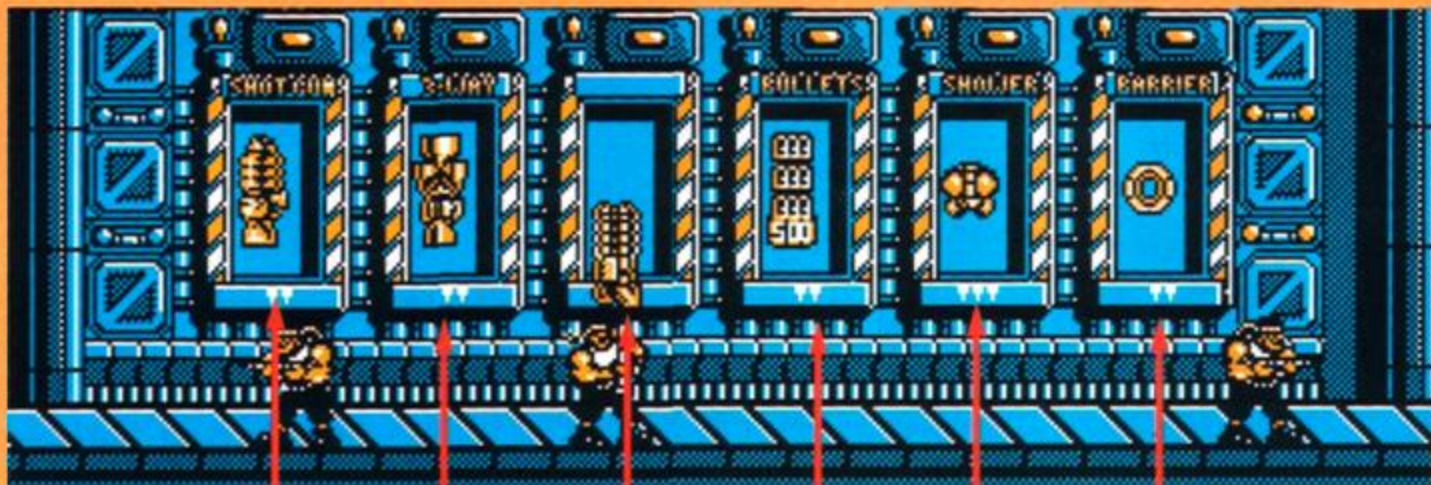

Shotgun – More powerful than your standard armament.

Flamethrower – A tongue of flame takes out anything at short range.

Shower bomb – For when the going gets tough.

Three-way shooter – shoots at 45 degrees either side too.

Extra ammo – 500 rounds to keep you going.

Barrier – For your protection.



● Level Three: Doesn't look too pleasant outside...!

sneaking up below, or trying to ambush from above, don't stand a chance.

As well as the all too common foot-soldiers, there's plenty of heavy artillery to overcome as well. These armoured enemies take several shots before bursting into a crimson ball of flame. Luckily, it's often possible to find a safe spot where you can hide from their line of fire while you're blasting them into oblivion.

There are nine levels of murder and mayhem to get through. Each one uses varied graphics, includes alternative big baddies, and has a very different feel to the rest.

The first level soon becomes quite easy – after a while, only careless mistakes will get

you killed. From then on, however, it's a different story, as each level is significantly tougher than the last. Luckily, at the end of each level there's a shop where you can purchase power-ups to overcome the increasingly hazardous obstacles. Among the weaponry on offer are three-way shooters, and flame throwers – guaranteed to roast anything in your path.

You'll have to choose carefully, though. These extras are bought with keys taken from the bad guys you've slain. You're only allowed to collect a maximum of six, so you'll have to spend them wisely, taking into account from experience what you'll be up against in the next level.

## ● LEVEL ONE

(Don't worry about picking up all the keys, by the way – you can only carry six anyway.)

Use the jeep as protection as you travel along the road. You can stand on top as it rolls over the enemies.







The action is depicted in the Amstrad's four colour mode. The sprites are fairly large and well detailed. Backgrounds, too, are good. The lack of colour can cause problems, though, and you can easily get confused as to what's actually happening. Green Screen owners beware!

Suitably futuristic music plays on the title screen, but in the game proper, sound is sparse. Just the usual explosion and shooting sounds, with little else.

The window in which the action takes

**SECOND OPINION**  
*"Midnight Resistance is an arcade game that lacks that principal arcade element - speed. Playable enough, however, once you get used to its slower pace of life. Also, the graphics get cluttered and confusing from time to time."*  
 RL

available? Perhaps it's the prospect of nine large levels to fight your way through? Whatever it is, it'll keep you playing well into the early hours. By midnight all resistance is useless...

Adam Waring



Keys. Dead guys drop these, pick them up for power ups later.

Ammunition count. Tells you how many bullets you've got left.

This tells you how many 'backpack' weapons you have.

Number of lives remaining.

*Not doing terribly well, are we...?*



place is fairly small. Presumably, this has been done for speed, but to little effect - the game still plays at a sluggish pace. When the edges of the tiny window are met, the playing area is page-scrolled to reveal more of the map.

*Midnight Resistance* is playable enough, but nothing really special. It has lost many of

the features of its arcade parent - any real speed, and the arcade game's two-player option are particularly conspicuous by their absence.

There is something compelling about the game that keeps you coming back for more, though. Maybe it's the vast array of weapons

**FIRST DAY TARGET SCORE**

Reach Level Three

**The Verdict**

**GRAPHICS** ..... 72%

- Good use of the four-colour mode.
- Sprites get a bit lost at times.

**SONICS** ..... 61%

- Reasonable title tune.
- Not many in-game effects.

**GRAB FACTOR** ..... 73%

- The action starts immediately.
- Slow...

**STAYING POWER** ... 84%

- Plenty of attractive weapons.
- Surprisingly addictive despite the sedate pace.

**AA RATING** ..... 77%

- A slow-moving but very playable game.

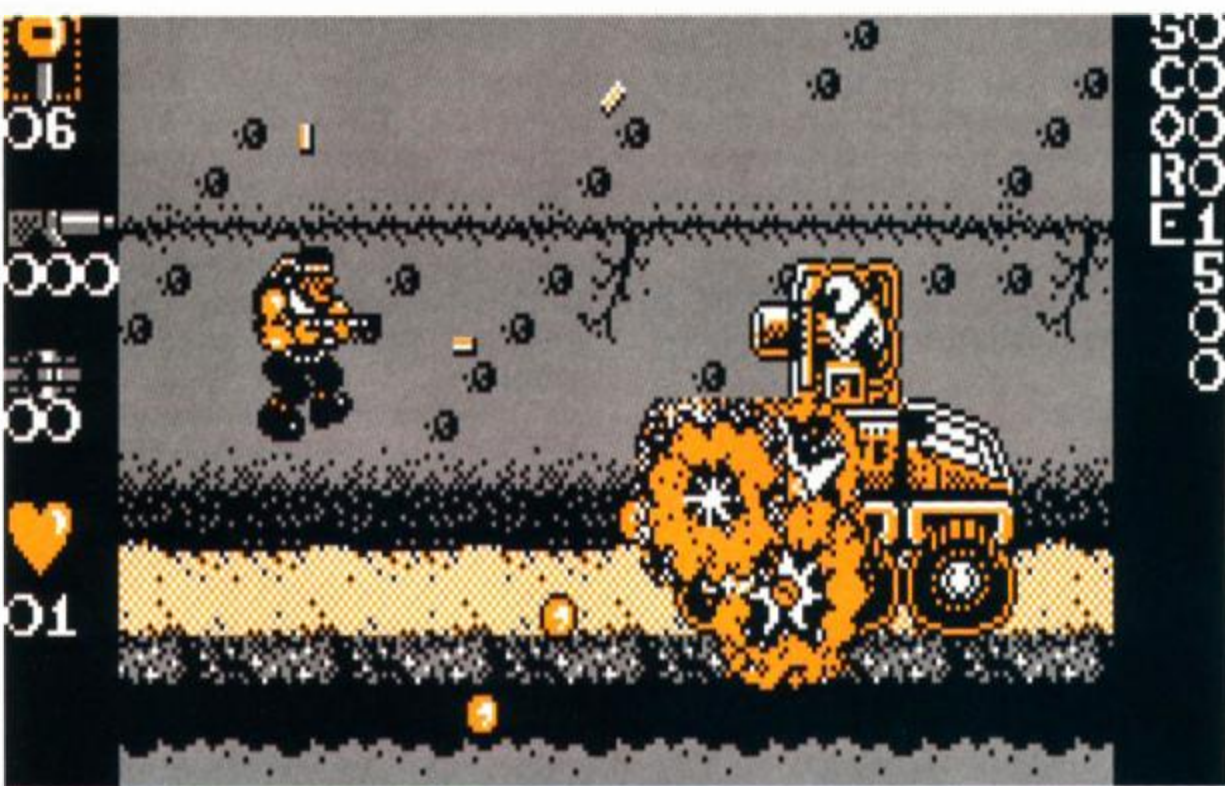

● End of level tank. Keep your finger on the trigger!

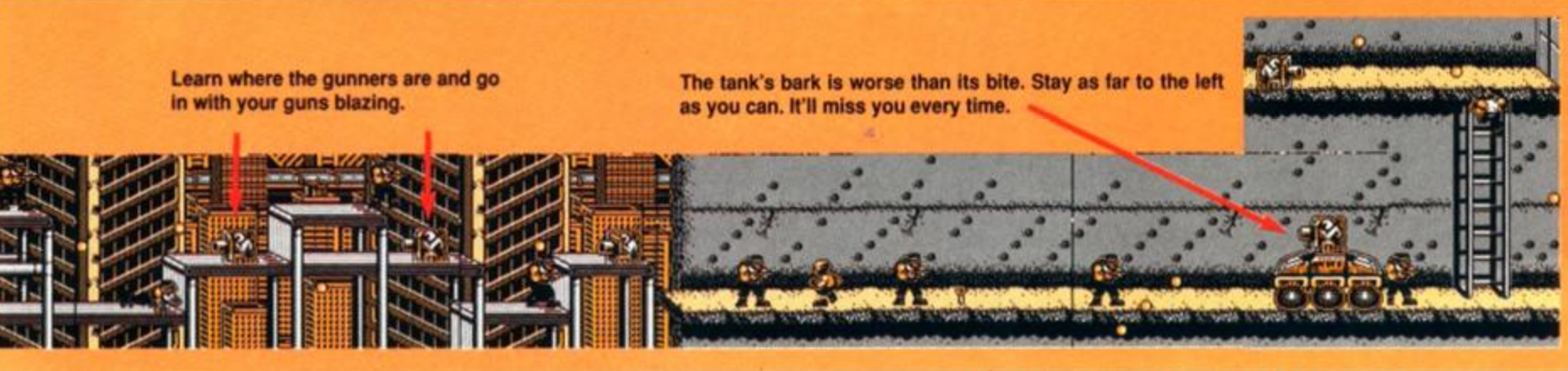

Learn where the gunners are and go in with your guns blazing.

The tank's bark is worse than its bite. Stay as far to the left as you can. It'll miss you every time.





# The AA Chrimbo page

You thought we'd forgotten, didn't you? Never! Here's a special festive page just for all those readers bloated with Christmas pud, sozzled by sherry and fed up to the back teeth of listening to Auntie Maude describing her hernia op over the stilton...

Last year we let you have a sneak preview of the AA team's Chrimbo pressie lists. And we're delighted to be able to do the same this year (send the writs to the usual address).

### Ollie Alderton

- 1 Some yellow crayons
  - 2 Some red crayons
  - 3 Some green crayons
  - 4 In fact a whole variety of crayons
  - 5 Something to put them in
- No, wait a minute. Start again...
- 1 A villa in St Tropez
  - 2 A very powerful pair of binoculars...
- (OK, you can stop right there - ed)

### James Leach

- 1 A year's membership of MENSA
- 2 The collected works of Leo Tolstoy
- 3 A BMW M635CSiA (plus heated gear knob)
- 4 A soul-mate (you mean cell-mate - ed)

### Adam Waring

```
10 INPUT "HOW MUCH MONEY WILL YOU GIVE ME?";M
20 IF M<1000000 PRINT "NOT ENOUGH, YOU MISERABLE
   CHEAPSKATING GIT!";GOTO 10
30 PRINT "ABOUT BLOOMIN' TIME!"
```

### Rod Lawton

- 1 A case of Moet et Chandon '63
- 2 2 gross finest Havana cigarillos
- 3 A whole plucked pheasant (oops, close one)
- 4 6cwt Christmas pudding plus 142 quarts double cream
- 5 A stomach pump

## THE AA PERSONALITY QUIZ

Yeah, c'mon, you don't just get these in *Cosmopolitan* y'know...

Here's your chance to probe the innermost depth of your psyche in our specially-constructed quiz, assembled by a team of expert psychoanalysts specially recruited from the pub next-door.

What you have to do is carefully read the questions, then note the answer that most closely corresponds with your own personality...

1. Your CPC breaks down on Christmas eve. Do you:
  - (a) Smash it with your joystick until it works?
  - (b) Phone Adam immediately, getting him out of the bath?
  - (c) Use a process of elimination to track down the cause?

2. Your granny asks you to explain *Laser Squad*. Do you:
  - (a) Blow her up with an auto-cannon
  - (b) Find the manual and explain it as you play?
  - (c) Admit you've never heard of it?

3. You're pushing a trolley through Sainsbury's car park and collide with a Battledroid from Zog. Do you?
  - (a) Smack it in the trunnion widget with your trusty thermic lance which you just happen to have with you?
  - (b) Be rather surprised and wonder whether you ought to tell someone?
  - (c) Dismantle it in the search for components for your ROM board project?

4. You're watching the Queen's Speech and your TV goes fuzzy. Do you?
  - (a) Assume it's Prince Philip?
  - (b) Phone the BBC?
  - (c) Stop fiddling with the telly?

5. You see Trenton Webb walking down the road. Do you:
  - (a) Run away in a zig-zag pattern and dive into the nearest bush?
  - (b) Say, "Hello, aren't you Trenton Webb?"
  - (c) Offer to show him your collection of screwdrivers?

6. *The Great Escape* is on the TV again this Xmas. Do you:
  - (a) Run out into the road and scream?
  - (b) Watch it anyway, because it's not that bad really?
  - (c) Change channels to watch the documentary on recirculating trunnion spigot flanges on BBC2?

## YOUR SCORE...

For each (a) answer, award yourself 0 points. For each (b) you should give yourself 2 points and for each (c) 4 points. Now add up your score and check the assessments below to find out just what sort of CPC owner you are:

- <0.0000001 There is nothing wrong with your brain that a small series of controlled explosions wouldn't put right.
- 0-8 You are a true games player who relies on sheer instinct and reaction time rather than any vestige of intellect.
- 8.0001-15.999 You are inclined to be pedantic. Your answers indicate a serious and common-sense approach to life which could get you into trouble in some parts of South America.
- 16-23 You are but one step away from being a trainspotting propellorhead. Have a care!
- 24 You are Adam Waring
- >24 You are seriously innumerate. We suggest you immediately enrol on a maths course at your local college. Have you ever owned a Spectrum?

## THE AA CHRISTMAS CAROL To be sung to the tune of 'God rest ye Merry Gentlemen...'

We love you Amstrad A-A-Action, you're first place on the grid  
On matters CPC-concerned, you really lift the lid  
In fact we think you're such a mag,  
We'll send you sixty quid

And it's Ty-y-pe-Ins of comfort and joy, comfort and joy  
And it's Ty-y-pe-Ins of comfort and joy

We love you Amstrad A-A-Action, you are so very funny  
With you upon our shopping list, the outlook's always sunny  
In fact it seems a good idea  
To send you all our money...

And it's Ty-y-pe-Ins of comfort and joy, comfort and joy  
And it's Ty-y-pe-Ins of comfort and joy

We love you Amstrad A-A-Action, we're always on the phone  
To tell you what a job you're doing, and that you're not alone  
In fact we'll send you all our praise  
And everything we own...

And it's Ty-y-pe-Ins of comfort and joy, comfort and joy  
And it's Ty-y-pe-Ins of comfort and joy

N.B. Repeat as necessary



# Balrog

releases... updates... previews... new releases... updates... previews...



NEWS...  
NEWS...  
NEWS...

Oops!

In a recent *AA the Adventure Probe* awards were mentioned and it was stated that Ken Bond's game *The Island* was awarded 'Best text only 8-bit adventure of the year' - this is, of course, not true! Although *The Island* is a great game, the award was actually given to Ken's adventure *The Test* - Sorry Ken! Fans of Ken's should look out for his latest game which is, I am reliably informed, ready now. Called *The Spiro Legacy*, it is a two-parter PAWed game and costs only £4.50 (disk-only) The Balg has been given a sneak preview and it looks to be Ken's best yet. Look out for the review soon. More details can be obtained from Ken at 17 Adel Park Gardens, Adel, Leeds LS16 8BN.

## Competition Results

The massive Balrog Birthday comp certainly was popular, even if it was printed incorrectly first time around! Out of the thousands of entries (OK, OK, perhaps I'm exaggerating a little!), the following lucky people were picked:

Mike Riggall, Linconshire • Gareth Jones, Edinburgh • Joan Pancott HPilg, Weymouth • Sue Ilsley, Prestbury • Bob Adams, Welwyn Garden City • S Marini, St. Annes • Stephen Borner, Doncaster • Ben Isba, Bowdon • Lorna Patterson, Tillicoultry • K Hankin, Aldridge.

All win copies of *Castle Master*, *Lords of Chaos*, *Bloodwych*, *Computer Adventures - The Secret Art* and a years subscription to the Adventurers Club Ltd. Mike Riggall's name was first out of the shoebox so he also wins an ADLAN ROM and a year's subscription to both *Adventure Probe* AND *Adventure Coder* - pheww! Well done, Mike.

The answers? Well, role-playing games on the CPC are few and far between but *Bards Tale*, *Swords and Sorcery* and *Rings of Darkness* are all examples of accepted answers. Incentive produces *GAC (Graphic Adventure Creator)*, ACL was started in 1985 and the Balrog first started writing for *AA* way back in *AA50* (way before Rod, Adam and James!) (Er, excuse me - at the same time as me and Adam, actually! - ed)

This month the Balrog treats you to a massive Cluepot and Lords & Ladies section. The reason? Well, why not! But seriously, next month's column will be an Adventure PD Special and will be jammed so full of reviews of all the games available on PD and there won't be much room for anything else! Merry Christmas...!

## BALROG'S POST

### ● The definitive adventure round-up?

I'm writing to tell you all about a series of articles I have written about all the known adventures still available for the Amstrad. These articles will appear in *Spellbreaker* from the January issue (No. 23). These will appear in the form of game description, mentioning the cost of each game, whether it's available on tape/disk and the address of the author or place available.

I think this will be a valuable service for new adventurers wanting to know where to buy games, as nearly all the software houses have withdrawn from the 8-bit adventure market.

I'm in regular contact with about a dozen authors at present and would gladly expand that quota, so if anyone wants their games mentioning in this series could they please write to me, mentioning prices, availability and giving me a short scenario of the game.

Tragically, many good authors have given up writing in the past because of lack of reviews - or not being given any magazine space (especially in the Pilgrim days...) and some really good games have been lost for ever. I don't want to see this happen again...

Mark Eltringham  
39 Gargle Hill  
Thorpe St Andrew  
Norwich, NR7 0XX

What a great idea, Mark! It always is useful to know where to buy those old games from. More details can be obtained from Mike Brailsford (*Spellbreaker* editor) at 19 Napier Place, South Parks, Glenrothes, Fife KY6 1DX or call 0592 757788.

### ● Where are they now?

Were the Infocom games *Plundered Hearts* and *A Mind Forever Voyaging* ever released for the CPC?

Peter Captijn  
Holland

Officially no, although I have heard rumours of a Mac version of *Plundered Hearts* running on the CPC. (Strange but true!)

### ● Size does count

If I buy the 64K memory expansion and the DD1 disk drive for my CPC 464, will I be able to play disk games like *Hitchhiker's Guide*, *Corruption*, *Pawn* etc without the 6128 ROM?

Jay Honosutomo  
Hemel Hempstead

You can play any Infocom game (such as *Hitchhiker's Guide* or *Suspect*) with just a DD1 and 464 - you don't need the expansion! BUT you will need both the expansion and a 6128 ROM to run any *Magnetic Scrolls* game (such as *Corruption* or *Guild of Thieves*). Buying a disk drive doesn't just mean you can play Infocom - it opens up the world of PAW, *Topologika* and *Graphical Level 9's* as well (later *Level 9* games were text-only on cassette).

### ● Where is Elvira?

Was *Elvira, Mistress of Darkness* ever released on the CPC?

Stephen Wilson  
Lancashire

*Elvira will not make an appearance on the CPC - sorry!*



### ● Calling all home-brewers...

I would like to hear from any home brew authors interested in a free review and advert in an electronic fanzine. No adventure turned away. Articles and contributions also wanted...

Simon Netherwood  
Rastrick

Sounds very interesting, Simon! Simon can be contacted at 36 Toothill Bank, Rastrick, Brighouse, West Yorkshire HD6 3EZ or telephoned on 0484 719326 5-9m weekdays. Don't forget to send me the final fanzine for a look!





# Clue Sniffing with the Balrog

A real stocking-filler of clues this month to take you through the Christmas holidays! A Ken Bond special this month, with tips for all of his games including a map of *The Island* drawn by Ken himself...!

Note well the names of the people below for they have come to you in your hour of need to aid and comfort you with their knowledge:

- Ken Stokoe, Northumberland
- Antcrusher, Seventh Plane
- Jerome Young
- Dave Harvard, Fareham
- Jungle DJ Towa Towa, Leeds
- Debby Howard, London
- Alistair Crook, Leeds
- Simon Avery, Chudleigh

Howard Swains and Ian Howlett

### Base

- To play tape: Find car, turn deck on, put tape in, press Play. (The hi-fi is a red herring and will only result in your death.) (*A dangerous herring!* – Balg)
- The combination for the safe in Part 1 is right 6, left 5, left to 3.
- Get key-ring with broom handle.
- Stick the photo in the space on the pass. To get the light to work, turn switch on.

### Cutthroats

- In the deep wreck, prop up the bunks with the iron bar.
- In the shallow wreck, to find some air, connect up the bottle and the compressor, then "fill tank with air". (This is a rare, fussy input from Infocom!)

### Dodgy Geezers

- Search the shop with pets for some cure for canine distemper.

- Follow the advice on the matchbook.
- Ask for a book on sewers (!) in the library.

### Dungeon Adventure

- Drop things on sleeping giants from up in the tree. This gets you a girdle of giant strength. Just the job for all those cluttery things adventurers just can't do without!

### Grange Hill (especially for the Kenderian)

- To get into school, use chair leg, "break lock".
- Give a dog a bone.
- You need the Plane to get the Matches.
- Don't bother to cross the canal, you reach it from the other side later in the game.
- Climb up the phone box.

### Heavy on the Magick

- At the start, do not pick up the book of spells as it is smeared in poison.
- To get into wolfdorp, say "DOOR, WOLF"
- To be raised to the grade of zelator, go to the door in secunda porta and say "DOOR, SILENCE"
- Mirror kills medusa.
- Nugget kills werewolf.
- Pellet kills slug.
- Garlic kills vampire.

### Island

- Turn the picture frame around to get the brass key, and use it to open the locked cabin.
- Put card in gap to gain entry to the captains office.
- Cut the hawser holding up the gangway with the axe to get down to water's level.

### Panic Beneath the Sea

- Push the book to make an exit.

### Price of Magic

- The candle is for the SPY spell.
- The grimoire is for the MAD spell.
- Burn the woodpile with the candle to get ashes (used for ZAP spell).
- Wave the mirror at moonbeast.
- The wheel is for ZED spell (the bat will get the wheel if asked).

### Suspect

- Hide behind comfy chair in library and wait.
- Follow the colonel after you see him in the library.
- Put body in window box to add more time.
- Hide behind BMW and wait.
- Open trunk of BMW.
- There is a way past the dogs!

### Test

The correct order for the buttons on the first wooden door is 285953719. Once inside, get cane, put letter in cane and light letter on elec-

## MAP OF THE ISLAND

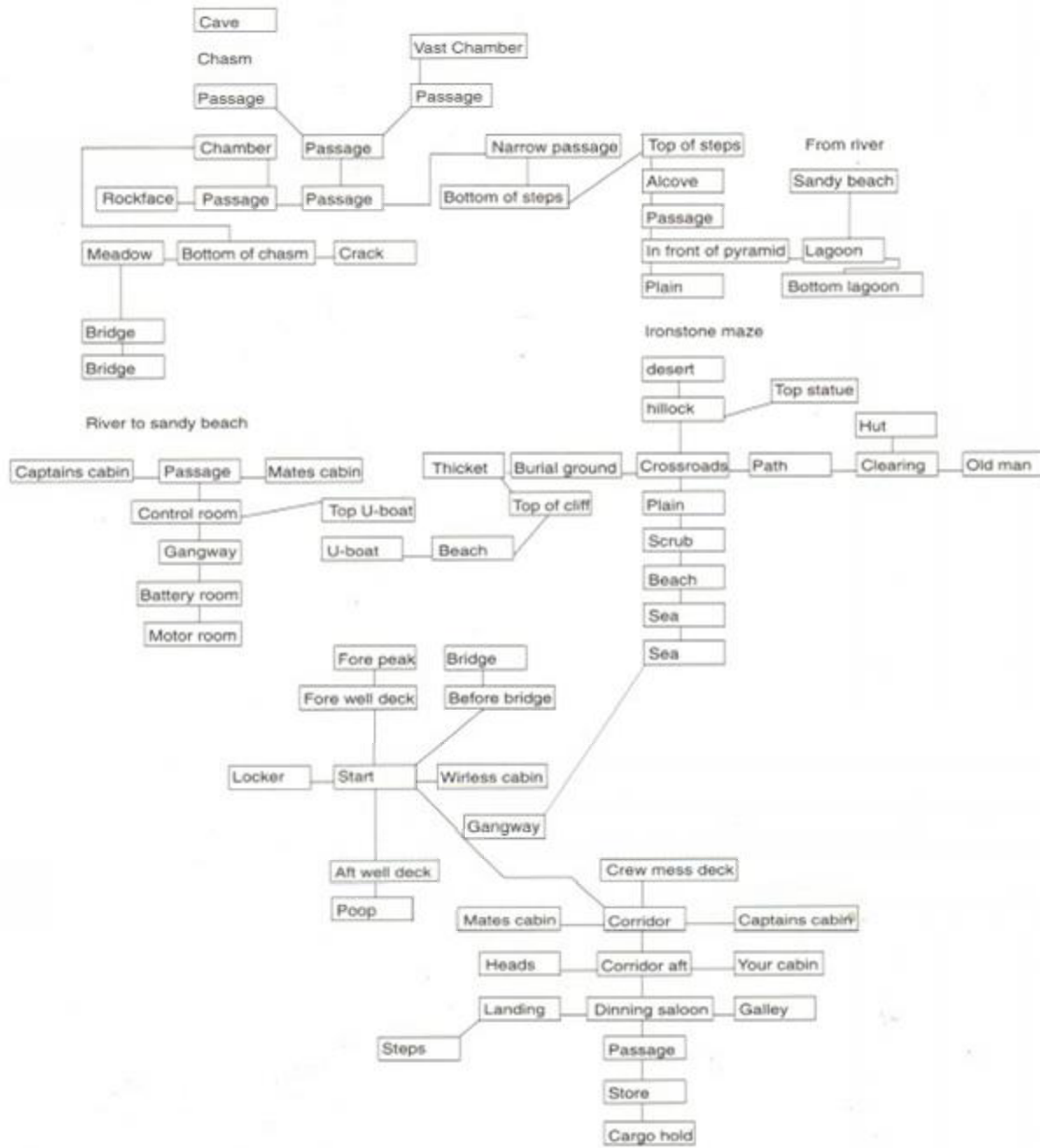



tric fire. Then melt the nylon rope... (and run!)  
Fire the gun at the hump (it's a mine).

**Ingrid's Back**

Robin Harley and R Melody offer help with Stephen Borner's problems:

- To open safe: Drop some evidence, E, get letter and hide. Wait for Jasper, examine Jasper (he then slides portrait and enters combination), get out, slide portrait, 888155 and get anything inside safe.

To get into Jasper's Bedroom: From reading room due west of Entrance Hall - Ux3, Ex2, in, N, out (In here you must press record when telephone rings, get tape and get photo from wallet).

- To get into Jasper's office: Go to Entrance Hall with Daisy, open door, Daisy, "out, wait 2, knock, wait 2, knock". When Daisy goes out the door, close door, U, wait until butler goes down, S, get paper, drawer and then stubs.

**Lord of the Rings**

Chris "The Barbarian" Gore from Mallow has the answers to Stephen Borner's questions:

- To get out of the old forest, after coming out of the tunnel into the mossy part of the for-

est blow out the stub of the candle, go E. If the trees block your way then wait till they move. From the Mossy place go Ex2, SE. This will get you out of the old forest, from there go S, NEx2, ask Tom Bombadil for help, SW, ask Tom for help, NE.

**Tombestowne**

Zac Taylor from Bristol has sent in clues as requested by Paul Stores:

- Get grey key from the bathroom next to the Master Bedroom. Get book from Master bedroom. Go to library (1st floor) with book, go to the left of the room, walk right and jump. You're now in the secret passageway. Go to the armoury, go to the bottom of the barrels and jump up and get shield. Go to hall. Go outside to "By the Bench". Drop book, go in tower to "End of Battlements", drop shield: this stops the arrows. Enter "Hut" and get rope on the table. Go out and go to the "Well", get bucket, drop rope and climb out of well...

**Help!**

Have you got a problem in an adventure that no-one you know can solve? If so then write to The Balrog at the usual address and your plea

for aid will be printed. Please only send in requests if you are desperate - use a Lord or Lady of Adventure if at all possible!

- **Alistair Crook** is stuck in **Heavy on the Magick** - what is the password for the eye of Heaven?

- **Stephen Wilson** needs help in **Panic beneath the Sea** and **City for Ransom**. In the former he wants to know the PIN number for the cash card and in City he wants to know how to open the clothes chest.

- **Chris "The Barbarian" Gore** is needy of advice in the **Lord of the Rings** - "In Part 1 I have Strider in my party and I keep following him around from Bree. I have found the message from Gandalf telling me to get an elfstone. I also got a message from Radagast the Brown via a bird. I pass Bree again only to get killed by the Dark Riders. Please help!"

- 'The Kenderian' needs help in **The Price of Magick**. He (she?) wants to know where the fieldspar lens and blue box are and how to get the wheel. (Use the bat - Balg.)

**Lords & Ladies of Adventure**

● Four new Lords of Adventure join us this month, including Mark Eltringham with a very impressive list of solved games.

As usual, treat the Lords and Ladies with the care and respect they deserve - ALWAYS keep phoning within reasonable hours (or those stated) and ALWAYS send a stamped SAE when writing - otherwise you won't get a reply! These people are giving away their time for nothing, so be considerate!

Adventure Quest • Angelique • Apache Gold • Arnold Blackwood Trilogy • Beer Hunter • Bestiary • Big Sleaze • Black Fountain • Black Knight • Boggit • Boredom • Bored of the Rings • Brawn Free • Can I Cheat Death (I & II) • Case of the Mixed-Up Shymer • Cave Capers • City for Ransom • Classic Adventure • Colossal Adventure • Colour of Magic • Crash Landing • Cricket Crazy • Dodgy Geezers • Doomlords • Dracula • Dungeon Adventure • DAA • Emerald Isle • Escape Alien Spaceship • Escape from Koshima • Espionage Island • Fantasia Diamond • Firestone • Football Frenzy • Frankenstein • Galaxias • Gems of Stradus • Ghosthouse • Grange Hill • Heavy on the Magick • Hobbit • Hunchback • Imagination • Ingrid's Back • Ichor • Island of Chaos • Jason of the Argonauts • Journey to Death • Kentilla • Knightmare • Knight Orc • Knight Tyme • Kobayashi Naru • Labyrinth • Lancelot • Life Term • Lords of Magic • Lord of the Rings • Lords of Time • Lost Shadow • Magicians Apprentice • Microman • Mindfighter • Mindshadow • Mordon's Quest • Mountains of Ket • Mural, Mystery of Indus Valley • Necris Dome • Never Ending Story • Not a Penny More Not a Penny Less

• Panic Beneath the Sea • Price of Magic • Project Annihilation • Project Volcano • Quest • Questprobe 3 • Quest for the Golden Egg-cup • Rebel Planet • Redhawk • Red Moon • Return to Eden • Revenge of Chaos • Rigel's Revenge • Robin of Sherwood • Roog • Scary Tales • Seabase Delta • Seas of Blood • Shard of Inovar • Shadows of Mordor • Sharpe's Deeds • Simply Magic • Smashed • Souls of Darkon • Spaced out • Star Wreck • Storm Mountain • Subunk • Talisman of Power • Terrormolinos • Tizpan • Top Secret • Venom • Welladay • Werewolf Simulator • Winter Wonderland • Wizbiz • Wolfman • Worm in Paradise • all Interceptor games!

**Mark Eltringham, 39 Gargle Hill, Thorpe St Andrew, Norwich, Norfolk NR7 0XX.**

Andy Capp • Price of Magic. (penpal also wanted)  
**The Kenderian, 475 Westhorne Ave, Eltham, London SE9 5LR.**

Jewels of Babylon  
**Chris "The Barbarian" Gore, 22 St. Anthony's Pk., Mallow, Co. Cork, Ireland.**

Gnome Ranger • Gremlins • Guild of Thieves • Ingrid's Back • Mordon's Quest • Price of Magic • Return to Eden • Rigel's Revenge • Scapeghost • Village of Lost Souls.  
**Robin Harley, 3 Shropshire Place, Eastgate, Peterborough, Cambs PE1 5BX.**

Crispin Crunchy • Crystal Theft • Gnome Ranger • Message from Andromeda • Scapeghost.  
**Jay Honosutomo, 23 Tintagel Close, Hemel Hempstead, Herts HP2 6NL. Tel between Mon-Fri, 4.30-9pm (0442) 242957**

Deadenders • Gnome Ranger • Hitchhiker's Guide • Lancelot • Quest for the Golden Eggcup • Rigel's Revenge • Smashed • Venom  
**Richard Jamieson, 79 Land Street, Rothes, Aberlour, Banffshire AB38 7BB.**

Adventure Quest • Angelique • Arnold Blackwood Trilogy • Big Sleaze • Black Fountain • Buggy • Case of the Mixed-Up Shymer • Castle Blackstar • Castle of the Skull Lord • Crystal Theft • Cursed Be the City • Cutthroats • Dracula • Dungeon Adventure • DAA • Enchanter • Escape from Koshima • Espionage Island • Fantasia Diamond • Football Frenzy • Frankenstein • Gnome Ranger • Gremlins • Guild of Thieves • Haunted House • Hermitage • Hitchhiker's Guide • Hollow Graphic • Hollow Text • Hollywood Hijinx • Hunchback • Imagination • Inca Curse • Infidel • Ingrid's Back • Jack the Ripper • Jinxter • Kingdom of Hamil • Kobayashi Naru • Lancelot • Leather Goddesses • Lifeterm • Lords of Time • Lurking Horror • Mansion • Mindshadow • Monsters of Murdac • Mordon's Quest • Mountains of Ket • Mystery of Indus Valley • Myth • Necris Dome • Never Ending Story • Nova • Nythyhel • Pawn • Planet of Death • Planetfall • Questprobe • Rebel Planet • Rigel's Revenge • Robin of Sherwood • Robocide • Seabase Delta • Shard of Inovar • Sharpe's Deeds • Ship of Doom • Smashed • Sorcerer • Souls of Darkon • Spellbreaker • Spytrek • Star Wreck • Subunk • Theseus • Top Secret • Venom • Very Big Cave Adventure • Winter Wonderland • Wishbringer • Wolfman and Zork I • II & III • all Interceptor games!  
**Graham Wheeler, 2 Burford Close, Southdown, Bath, Avon BA2 1JF. Tel between 10am and midnight (0225) 426919**



# Type-ins

JAMES LEACH sorts through another mailbag full of ripper routines...



Christmas is a time for festivities, and for making merry. And what do merry people do? They sing lustily. The fact that they

do this at 3am in the road outside my house, to the accompaniment of breaking glass and swearing doesn't seem to spoil their enjoyment. It certainly spoils mine.

## ALTO

Anyway, this musical type-in comes courtesy of Val Robinson of Fulham in London. We wouldn't dare to guess which sex Val is (we've learnt our lesson), but he/she has produced a piano-style keyboard which indicates the notes as you play them. It's very simple and great fun. You just use the second and third rows of computer keys to simulate the notes. f0 to f8 are programmed to go higher up the scale.

Try playing the following Christmassy tune. It's 'Ding-Dong Merrily On High':

:::lkj jk::l:

```
(LqAi)10.'
(NpAt)20.'ALTO'by Val Robinson
(EiAs)30.MODE:0:BORDER:0:RESTORE
(JsAq)40.FOR:p=2.T0.15
(KuAl)50.INK.p.13
(MlAk)60.NEXT.p
(LrAw)70.INK.1,13:INK.0,1:GRAPHICS.PEN.0
(EnBn)80.'Draw piano keys on lower half of screen.
(PqBp)90.WINDOW.#3,1,20,14,25:PAPER.#3,1:PEN.#3,0:CLS.#3
(DnAu)100.FOR:x=160.T0.576.STEP.32
(NuAq)110.PLOT.x,60:DRAWR.0,95
(CsAn)120.NEXT.x
(CxAt)130.PLOT.160,60:DRAWR.416,0
(AqAs)140.PLOT.150,156:DRAWR.436,0
(KvAv)150.FOR:x=150.T0.566.STEP.32
(AtBr)160.IF.x=214.OR.x=310.OR.x=438.OR.x=534.THEN.GO.T0.180.
(DwCj)170.PLOT.x,156:DRAWR.0,-64:DRAWR.20,0:DRAWR.0,64:MOVER.-12,-2:FILL.0
(JoAl)180.NEXT.x
(LqAo)190.MOVE.165,75
(EuAp)200.FOR:n=3.T0.15
(PmAl)210.FILL.n
(HxAp)220.MOVER.32,0
```

```
(DoAl)230.NEXT.n
(LkBq)240.'Draw musical notes in upper half of screen.
(CsBt)250.WINDOW.#2,1,20,1,11:PAPER.#2,0:PEN.#2,1:CLS.#2
(OnAw)260.PRINT.#2,CHR$(22);CHR$(1)
(PjBk)270.'Define new characters for the notes.
(InBp)280.DIM.a(27),b(27),c(27),d(27),e(27),f(27),g(27),h(27)
(LvAp)290.SYMBOL.AFTER.32
(KuAq)300.FOR:x=1.T0.26
(IqBu)310.READ.a(x),b(x),c(x),d(x),e(x),f(x),g(x),h(x))
(BiBx)320.SYMBOL.x+199,a(x),b(x),c(x),d(x),e(x),f(x),g(x),h(x))
(EmAl)330.NEXT.x
(BsAj)340.'
(HsBm)350.LOCATE.#2,1,2:PRINT.#2,CHR$(95);CHR$(217)
(ErBo)360.LOCATE.#2,1,3:PRINT.#2,CHR$(95);CHR$(218)
(MrBn)370.LOCATE.#2,1,4:PRINT.#2,CHR$(223);CHR$(219)
(OvBo)380.LOCATE.#2,1,5:PRINT.#2,CHR$(224);CHR$(220)
(HuBp)390.LOCATE.#2,1,6:PRINT.#2,CHR$(225);CHR$(221)
(HvBn)400.LOCATE.#2,1,7:PRINT.#2,CHR$(215);CHR$(222)
(JnAo)410.FOR:n=1.T0.5
(LkAp)420.FOR:x=3.T0.19
(KuAp)430.LOCATE.#2,x,n+1
(KxAr)440.PRINT.#2,CHR$(95);
(FkAm)450.NEXT.x
(AoBk)460.IF.n=1.THEN.PRINT.#2,CHR$(133)
(EkBk)470.IF.n=1.THEN.PRINT.#2,CHR$(206)
(HpAl)480.NEXT.n
(PxBo)490.LOCATE.#2,5,10:PRINT.#2,"GABCDEF GABCDEF"
(OjBl)500.LOCATE.#3,6,10:PRINT.#3,"ASDFGHJKL;11"
(GmBn)510.PEN.#2,2:LOCATE.#2,4,8:PRINT.#2,CHR$(214)
(CmBn)520.'Assign note, pen and characters to keys.
(BqBm)530.DIM.t(27),n(27),p(27),v(27,3),x(27)
(NwCq)540.'t=tone period, n=key number, p=pen number, v=character element, x=x coordinate.
(FsAj)550.'
(BtAq)560.FOR:z=1.T0.27
(NkAv)570.READ.t(z),n(z),p(z),x(z)
(DlAv)580.IF.p(z)=1.THEN.GOTO.660
(FjAo)590.FOR:r=1.T0.3
(FnAp)600.READ.v(z,r)
(NkAo)610.PEN.#2,p(z)
(AiBx)620.IF.p(z)>10.THEN.LOCATE.#2,p(z)+3,13-CINT((p(z))/2)-r
(LkBu)630.IF.p(z)<11.THEN.LOCATE.#2,p(z)+3,12-CINT((p(z)+1)/2)-r
(MuAs)640.PRINT.#2,CHR$(v(z,r))
(NqAl)650.NEXT.r
(NoAv)660.KEY.z+127,CHR$(z+32)+CHR$(13)
(BpAs)670.KEY.DEF.n(z),0,z+127
(HnAl)680.NEXT.z
(JuAi)690.'
(BuBj)700.'Now for the noise on keypress...
(IwAv)710.MOVE.x(1),150:FILL.2
(DnAm)720.ch=1
(LsAo)730.ENV.1,15,-1,1
(IqAx)740.a$=INKEY$:IF.a$="" THEN.740
(ApAq)750.k=ASC(a$)-32
(DnAv)760.IF.k>27.OR.k<1.THEN.740
(HrCp)770.IF.p(k)=1.AND.k<24.THEN.MOVE.x(k),150:FILL.p(k-1):MOVER.-18,0:FILL.1
(ErBi)780.IF.p(k)>2.THEN.INK.p(k),6
(AoBp)790.IF.p(k)=1.AND.NOT.k=1.THEN.INK.p(k-1),18
(LvAu)800.IF.p(k)=2.THEN.INK.2,18
(CxBn)810.IF.k=26.OR.k=24.THEN.INK.p(k),6
(AuAr)820.WHILE.INKEY(n(k))=0
```

```
(EjAs)830.SOUND.ch,t(k),1,15
(AnAl)840.WEND
(PqAt)850.SOUND.ch,t(k),0,0,1
(CiAx)860.ch=ch*2:IF.ch=0.THEN.ch=1
(ElBm)870.INK.p(k),13:IF.NOT.k=1.THEN.INK.p(k-1),13
(LiBx)880.IF.p(k)=1.AND.k<24.THEN.FILL.p(k-1):MOVER.18,0:FILL.1
(DwAm)890.GOTO.740
(HiAj)900.'
(BjBl)910.'Data for defining new characters.
(KnAj)920.'
(DxIn)930.DATA.4,20,60,124,56,16,0,0,0,0,0,0,4,4,4,12,6,4,4,4,4,20,60,254,56,16,0,0,0,0,0,0,0,0,0,0,4,4,4,4,4,4,4,4,20,60,124,0,0,0,0,0,0,0,240,32,32,32,0,0,0,0,32,32,32,32,32,32,32,32,60,40,32,32,32,32,32,0,0,0,0,8,28,62,4,4,4,4,4,4,4,4
(KqDp)940.DATA.0,8,28,62,60,40,32,32,20,60,124,56,16,0,0,0,0,2,11,30,15,26,8,0,6,14,8,4,3,0,0,0,4,4,4,4,4,126
(GsGv)950.DATA.0,2,7,15,19,19,19,255,19,19,19,22,22,2,2,28,255,28,56,56,112,240,208,144,255,56,124,21,19,19,19,19,255,18,20,20,24,248,16,16,255,16,1,16,32,192,0,0,0,0,0,0,0,1,3,255,14,28,60,113,113,114,114,255,49,24,12,2,1,0,0,255
(AuAj)960.'
(DqBn)970.'Data for variables associated with each note.
(EiAj)980.'
(AnGl)990.DATA.301,67,2,164,213,216,201,204,69,3,0,26,3,202,216,268,59,1,196,253,60,4,0,213,216,204,2,9,61,5,0,203,202,211,225,50,1,260,213,53,6,0,21,211,204,201,51,1,292,190,52,7,0,203,205,211,17,44,8,0,200,211,204,169,42,1,356
(PwBw)1000.DATA.159,45,9,0,203,205,211,150,35,1,388,42,37,10,0,200,211,204
(BwGw)1010.DATA.134,34,1,420,127,36,11,0,208,209,210,119,29,12,0,207,208,212,113,26,1,404,106,20,13,208,209,210,100,17,1,516,95,19,14,0,207,208,21,89,13,15,0,208,209,210,84,20,1,500,80,14,1,0,7,12,1,0,71,5,1,0,67,4,1,0
```

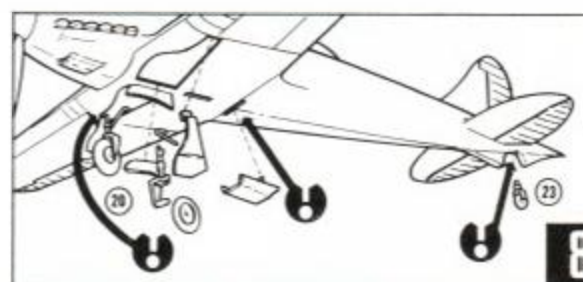

## 360 DEGREES

This little scorcher is from Simon Clarke of Princes Risborough in Buckinghamshire. Simply change the contents of text\$ in line 00 to put in whatever message you choose. Hours (well, seconds) of fun can be had. The clever part is how the phrase is expanded or contracted to fit exactly into the circle.

```
(MlCq)10.MODE:1:mo=16:INK.0,0:INK.1,26:INK.2,6:INK.3,24:BORDER:0:text$="360 DEGREES BY S. CLARK"
(BnBj)20.le=120:he=120:th=64:x=320:y=200:col=1
(IpCn)30.length=LEN(text$):steps=360/length:sti=steps/length:thi=th/mo:col=1
(KrAv)40.LOCATE.1,25:PRINT.TEXT$
```





```
(KIAs)50.FOR.nu=0.TO.length-1
(KkBi)60.FOR.i=0.TO.no-1:FOR.o=0.TO.no-1
(JoBi)70.IF.TEST((nu*no)+i,o)<0.THEN.90
(CtAq)80.NEXT.o,i,nu:END
(FtBn)90.de=(nu*steps)-stiwi-180:th=thiwo:DEG
(CwBs)100.PLOT.x+(le+th)*COS(de),y+(he+th)*SIN(de),co
l:GOTO.80
```

# MUSICAL CHORDS AND SCALES

Continuing the musical theme, this offering from David Webber of the Isle Of Man, is a serious application. It will identify the notes in many chords and scales. As well as major, minor and augmented, it will handle a great many other chords and sequences. One for the REAL musicians around.



```
KiAu)10.REM.MUSICAL.CHORDS.AND.SCALES
FnAu)20.REM.-----
IvAj)30:
PsAk)40.CLS
FlAl)50.MODE.2
KwAo)60.LOCATE.20,1
MnBn)70.PRINT"TABLES.OF.MUSICAL.CHORDS.AND.SCALES"
PmAu)80.PRINT.TAB(20)STRING$(35,"-")....
KkBy)90.PRINT.TAB(21)"Copyright-
David.T.Webber.1990"....
DtAu)100.PRINT:PRINT:PRINT:PRINT
RuCn)110.PRINT.TAB(8)"This.program.enables.the.music
ian.to.check.out.any.of.11"
WmAn)120.PRINT
toCn)130.PRINT.TAB(8)"chords.for.use.with.an.organ,
piano.or.stringed.instrument."
TkAl)140.PRINT
lvCj)150.PRINT.TAB(8)"In.addition.he.is.able.to.trans
pose.notes.between.any.two"
foAl)160.PRINT
fvBu)170.PRINT.TAB(8)"keys.and.relate.them-
to.any.of.11.scales."....
ItAu)180.PRINT:PRINT:PRINT:PRINT
KkBy)190.PRINT.TAB(8)"Press.any.key.to.continue"....
WmAx)200.a$=INKEY$:IF.a$="" THEN.200
ItAl)210.CLS
IsCi)220.PRINT.TAB(10)"T.A.B.L.E..O.F..C.H.O.R.D.S
..A.N.D..S.C.A.L.E.S"....
WmAu)230.PRINT.TAB(10)STRING$(50,"-")....
KkAo)240.PRINT:PRINT
IvBq)250.PRINT.TAB(15)"Chords";TAB(40)"Scales"....
rBo)260.PRINT.TAB(15)"-----";TAB(40)"-----
"....
IvAl)270.PRINT
IvBp)280.PRINT.TAB(15)"1...Major";TAB(40)"12...Major
"....
WmBt)290.PRINT.TAB(15)"2...Minor";TAB(40)"13...Natur
al.Minor"....
xwBu)300.PRINT.TAB(15)"3...Augmented";TAB(40)"14...H
armonic.Minor"
WmBx)310.PRINT.TAB(15)"4...Major.6th";TAB(40)"15...M
elodic.Minor"
pCj)320.PRINT.TAB(15)"5...Minor.6th";TAB(40)"16...H
ungarian.Minor"
jBx)330.PRINT.TAB(15)"6...Dominant.7th";TAB(40)"17.
..Dorian.Mode"
nBu)340.PRINT.TAB(15)"7...Major.7th";TAB(40)"18...P
hygrian.Mode"
oCi)350.PRINT.TAB(15)"8...Minor.7th";TAB(40)"19...L
```

```
ydian.Mode"
(MmCi)360.PRINT.TAB(15)"9...Diminished.7th";TAB(40)"2
0...Mixolydian"
(GuCj)370.PRINT.TAB(14)"10...Dominant.9th";TAB(40)"21
...Locrian.Mode"
(EtCk)380.PRINT.TAB(14)"11...Diminished.9th";TAB(40)"
22...Whole.Tone"
(CrAp)390.LOCATE.14,22
(AwBj)400.INPUT"Select.between.1.and.22:";x
(IjBl)410.IF.x<1.OR.x>22.THEN.CLS:GOTO.220....
(HmAk)420.CLS
(KsBx)430.IF.x<11.THEN.PRINT"Y.R.A.N.S.P.O.S.I.T.I.O
N...O.F...S.C.A.L.E.S"....
(KwBk)440.IF.x<11.THEN.PRINT.STRING$(45,"-")....
(BqBl)450.IF.x<12.THEN.PRINT"C..H..O..R..D..S"
(CuBn)460.IF.x<12.THEN.PRINT.STRING$(16,"-")....
(KiAl)470.PRINT
(OoCk)480.PRINT"Insert.key.signature.followed.by.'s'
for.sharp.and.'f'for.flat."
(DnAp)490.PRINT:PRINT
(KuBp)500.IF.x=1.THEN.PRINT"Major.....1.....
.....3.....5"....
(BlBs)510.IF.x=2.THEN.PRINT"Minor.....(m)....1.....
.....3.....5"....
(NrBr)520.IF.x=3.THEN.PRINT"Augmented..(+)...1.....
.....3.....5"....
(DxBv)530.IF.x=4.THEN.PRINT"Major.6th...(6)..1.....
.....3.....5.....6"....
(AmCi)540.IF.x=5.THEN.PRINT"Minor.6th..(m6)..1.....
.....3.....5.....6"....
(LiBu)550.IF.x=6.THEN.PRINT"Dominant.7th.(7).1.....
.....3.....5.....7"....
(DmBv)560.IF.x=7.THEN.PRINT"Major.7th.(m7)..1.....
.....3.....5.....7"....
(FuBu)570.IF.x=8.THEN.PRINT"Minor.7th..(m7)..1.....
.....3.....5.....7"....
(PmBx)580.IF.x=9.THEN.PRINT"Diminished.7th..1.....
.....3.....5.....7.....
.....(dim)"
(JpBx)590.IF.x=10.THEN.PRINT"Dominant.9th.....1.....
.....3.....5.....7.....
.....9.....(9)"
(DlBu)600.IF.x=11.THEN.PRINT"Diminished.9th..1.....
.....3.....5.....7.....9.....
.....(-9)"
(JmCi)610.IF.x=12.THEN.PRINT"Major.Scale.....1.....
.....2.....3.....4.....5.....6.....7.....8"....
(LqCi)620.IF.x=13.THEN.PRINT"Natural.Minor...1.....
.....2.....3.....4.....5.....6.....7.....8"....
(BiCi)630.IF.x=14.THEN.PRINT"Harmonic.Minor...1.....
.....2.....3.....4.....5.....6.....7.....8"....
(CwCi)640.IF.x=15.THEN.PRINT"Melodic.Minor...1.....
.....2.....3.....4.....5.....6.....7.....8"....
(HmCk)650.IF.x=16.THEN.PRINT"Hungarian.Mode...1.....
.....2.....3.....4.....5.....6.....7.....8"....
..
(DxCj)660.IF.x=17.THEN.PRINT"Dorian.Mode.....1.....
.....2.....3.....4.....5.....6.....7.....8"....
(HxCj)670.IF.x=18.THEN.PRINT"Phygrian.Mode...1...2...
.....3.....4.....5.....6.....7.....8"....
(JvCi)680.IF.x=19.THEN.PRINT"Lydian.Mode.....1.....
.....2.....3.....4.....5.....6.....7.....8"....
(KjCj)690.IF.x=20.THEN.PRINT"Mixolydian.Mode...1.....
.....2.....3.....4.....5.....6.....7.....8"....
(BwCj)700.IF.x=21.THEN.PRINT"Locrian.Mode.....1...2...
.....3.....4.....5.....6.....7.....8"....
(DmBu)710.IF.x=22.THEN.PRINT"Wholetone.Mode...1.....
.....2.....3.....4.....5.....6.....7"....
(OoAt)720.WINDOW#2,1,80,9,24....
(NxCn)730.n$="C.C#D.D#E.F.#G.A.A#B.C.C#D.D#E.F.#G
.C#A.A#B.C.C#D.D#E"....
(MsBx)740.m$="C.D#D.E#E.F.G#G.A#A.B#B.C.D#D.E#E.F.G#G
.A#A.B#B.C.D#D.E#E"....
(EsCj)750.LOCATE#2,1,1:LINE.INPUT#2,"Basic.key:";bs$:
LOCATE#2,1,1:PRINT#2,SPACE$(20)....
(KwAr)760.bs$=UPPER$(bs$)
(MrAx)770.IF.bs$="S" THEN.GOTO.750....
(BsBx)780.IF.INSTR("AFASBFCSDFDSEFSGFGS",bs$)=0 THEN.
GOTO.750....
```

```
(PmAu)790.PRINT#2,"Basic.key:.....";
(HvAx)800.GOSUB.1000:GOSUB.890:GOTO.810
(MtAq)810.PRINT#2:PRINT#2
(KiAv)820.IF.x<12.THEN.GOTO.980
(BmCl)830.LOCATE#2,1,4:LINE.INPUT#2,"Transposed.key:"
";bs$:LOCATE#2,1,4:PRINT#2,SPACE$(20)....
(LlAs)840.bs$=UPPER$(bs$)....
(DlAx)850.IF.bs$="S" THEN.GOTO.830
(MnBv)860.IF.INSTR("AFASBFCSDFDSEFSGFGS",bs$)=0 THEN.
GOTO.830
(AiAv)870.PRINT#2,"Transposed.key:.....";...
(FvAx)880.GOSUB.1000:GOSUB.890:GOTO.980
(EkCn)890.IF.bs$="C".OR.bs$="F".OR.MID$(bs$,2,1)="F".
THEN.GOTO.940.ELSE.900
(DvAv)900.FOR.d=z.TO.z+28.STEP.2....
(OwAu)910.PRINT#2,MID$(n$,d,2);" ";....
(KsAk)920.NEXT
(EAn)930.GOTO.970
(OmAv)940.FOR.d=z.TO.z+28.STEP.2....
(FrAt)950.PRINT#2,MID$(n$,d,2);" ";....
(BkAk)960.NEXT
(CpAn)970.RETURN
(GnAt)980.PRINT#2:PRINT#2:PRINT#2
(FtBx)990.PRINT#2,"Do.you.want.another.key.signature.
..Press.1"
(DrAm)1000.PRINT#2
(JsCj)1010.PRINT#2,"Do.you.want.another.Chord.or.Scal
e..Press.2"....
(FtAn)1020.PRINT#2
(HjBw)1030.LOCATE#2,1,12:INPUT#2,"Input: ";p:LOCATE#2
,1,12:PRINT#2,SPACE$(20)....
(PrBl)1040.IF.p=1.THEN.CLS#2:GOTO.730....
(DnBi)1050.IF.p=2.THEN.CLS:GOTO.220....
(JxBk)1060.IF.p<1.OR.p>2.THEN.GOTO.1030....
(IkAk)1070:
(KxAu)1080.IF.bs$="C" THEN.z=1....
(IvBn)1090.IF.bs$="CS".OR.bs$="DF" THEN.z=3....
(EiAu)1100.IF.bs$="D" THEN.z=5....
(JkBl)1110.IF.bs$="DS".OR.bs$="EF" THEN.z=7....
(OvAu)1120.IF.bs$="E" THEN.z=9....
(FqAx)1130.IF.bs$="F" THEN.z=11....
(FiBn)1140.IF.bs$="FS".OR.bs$="CF" THEN.z=13....
(IrAu)1150.IF.bs$="G" THEN.z=15....
(KkBl)1160.IF.bs$="GS".OR.bs$="AF" THEN.z=17....
(GrAu)1170.IF.bs$="A" THEN.z=19....
(EvBn)1180.IF.bs$="AS".OR.bs$="BF" THEN.z=21....
(LiAu)1190.IF.bs$="B" THEN.z=23....
(BmBn)1200.IF.bs$="BS".OR.bs$="CF" THEN.z=25....
(PkAn)1210.RETURN
```

# BLOCK-BUILDERS

This game, from Adrian Hyland of Hawarden in Clwyd, sets you building piles of blocks which fall from the sky. It's a long piece of code, but is certainly worth typing in. The quality is superb. The idea isn't a hundred per cent original, but very nicely implemented.

```
(OwAl)10.'..TETRIS
(PoAj)20.'...by
(FjAn)30.'A.Hyland
(EtAj)40.'
(HuAl)50.'
(CxAn)60.'Set.up.game
(NwAl)70.'
(DkAo)80.GOSUB.1890
(EiAj)90.'
(BnAo)100.'Main.loop
(HsAj)110.'
(BnAp)120.WHILE.True%
(FnBi)130.Score%-=0:Level%-=0:MaxRows%-=4
(JrAp)140.Full%-=False%
(IvAp)150.RESTORE.2980
(CtAp)160.CLEAR.INPUT
```

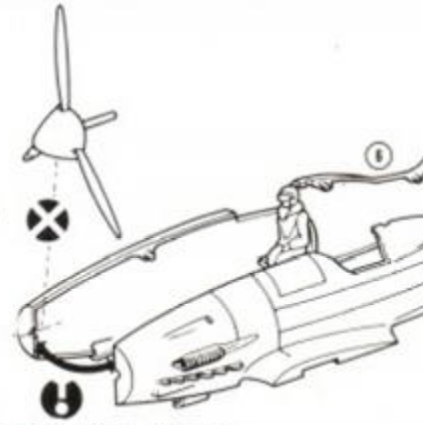









```
(NvAp)2290·READ·xsx,ysx
(EqBk)2300·ShapeArrayX(1,n2x,0,n1x)·=·2*xsx
(MsBi)2310·ShapeArrayX(2,n2x,0,n1x)·=·80*ysx
(IoBk)2320·ShapeArrayX(1,n2x,1,n1x)·=·2*ysx
(BvBm)2330·ShapeArrayX(2,n2x,1,n1x)·=·240-80*xsx
(IvBm)2340·ShapeArrayX(1,n2x,2,n1x)·=·6-2*xsx
(NxBn)2350·ShapeArrayX(2,n2x,2,n1x)·=·240-80*ysx
(LxB1)2360·ShapeArrayX(1,n2x,3,n1x)·=·6-2*ysx
(MuBi)2370·ShapeArrayX(2,n2x,3,n1x)·=·80*xsx
(MuAm)2380·NEXT·n2x,n1x
(AuBj)2390·FOR·n1x·=·0·TO·6·FOR·n2x·=·0·TO·3
(AjAr)2400·FOR·n3x·=·0·TO·3
(BuAo)2410·nX·=·15
(MnAp)2420·FOR·n4x·=·0·TO·3
(CtEv)2430·IF·(ShapeArrayX(1,n3x,n2x,n1x)=ShapeArrayX
(1,n4x,n2x,n1x)+2)·AND·(ShapeArrayX(2,n3x,n2x,n1
x)=ShapeArrayX(2,n4x,n2x,n1x)+80)·THEN·nX·=·nX-8
(BqEw)2440·IF·(ShapeArrayX(1,n3x,n2x,n1x)=ShapeArrayX
(1,n4x,n2x,n1x)-
2)·AND·(ShapeArrayX(2,n3x,n2x,n1x)=ShapeArrayX(2
,n4x,n2x,n1x)+80)·THEN·nX·=·nX-4
(LwEu)2450·IF·(ShapeArrayX(1,n3x,n2x,n1x)=ShapeArrayX
(1,n4x,n2x,n1x))·AND·(ShapeArrayX(2,n3x,n2x,n1x)
=ShapeArrayX(2,n4x,n2x,n1x)+80)·THEN·nX·=·nX-2
(MjEx)2460·IF·(40*ShapeArrayX(1,n3x,n2x,n1x)=ShapeArr
ayX(1,n4x,n2x,n1x))·AND·(ShapeArrayX(2,n3x,n2x,n
1x)=320-
40*ShapeArrayX(2,n4x,n2x,n1x))·THEN·nX·=·nX-1
(LjAm)2470·NEXT·n4x
(MoBi)2480·ShapeArrayX(0,n3x,n2x,n1x)=nX
(IjAq)2490·NEXT·n3x,n2x,n1x
(KtAp)2500·RESTORE·3160
(JtAn)2510·lx·=·&6000
(LqAp)2520·WHILE·lx<&6233
(AwAo)2530·READ·d$
(BsAx)2540·FOR·nX·=·-1·TO·LEN(d$)·STEP·2
(EvBi)2550·POKE·lx,VAL("&"+MID$(d$,nX,2))
(MnAo)2560·lx·=·lx+1
(KpAm)2570·NEXT·nX
(LsAk)2580·WEND
(CpAp)2590·RESTORE·3120
(OnAp)2600·FOR·ix·=·0·TO·7
(EvBr)2610·READ·i0X,i1X:InksX(0,ix)·=·i0X:InksX(1,ix)
·=·i1X
(KkAl)2620·NEXT·ix
(FrBi)2630·ShowNextShapeX·=·FalseX
(KxAo)2640·GOSUB·1460·
(CjBl)2650·CLS:INK·0,0:INK·1,0:INK·3,0:PAPER·0
(IwBr)2660·FOR·nX·=·9·TO·12:LOCATE·16,nX:PRINT·"...."
:NEXT·nX
(LuAq)2670·PAPER·1:PEN·3
(IwAu)2680·LOCATE·16,8:PRINT·"NEXT"
(HkAx)2690·LOCATE·16,15:PRINT·"KEYS·....."
(HvAu)2700·LOCATE·16,16:PRINT·"....."
(HkBp)2710·LOCATE·16,17:PRINT·CHR$(242);":LEFT·(SP)
:DROP·"
(FvAu)2720·LOCATE·16,18:PRINT·"....."
(FwBp)2730·LOCATE·16,19:PRINT·CHR$(243);":RIGHT·7:RE
VEAL·"
(MoAx)2740·LOCATE·16,20:PRINT·"....."
(DiBu)2750·LOCATE·16,21:PRINT·CHR$(241);":ROTATE·9:PA
USE·"
(BtBk)2760·LOCATE·21,8:PRINT·"SCORE·:·.....0·"
(IvAv)2770·LOCATE·21,9:PRINT·"....."
(DwBk)2780·LOCATE·21,10:PRINT·"LEVEL·:·.....1·"
(LvAw)2790·LOCATE·21,11:PRINT·"....."
(FrBk)2800·LOCATE·21,12:PRINT·"ROWS·:·.....5·"
(FoAs)2810·CALL·&6600,&C0BC
(MvAu)2820·CALL·&606B,@BoardX(1,0)
(KiBi)2830·INK·0,13:INK·1,6:INK·3,24:PAPER·0
(MoAn)2840·RETURN
(JuAj)2850·'
(EsAo)2860·'·Shape·data
(FiAj)2870·'
(LqAt)2880·DATA·1,1,2,1,1,2,2,2
(MpAq)2890·DATA·0,1,1,1,2,1,3,1
(EtAu)2900·DATA·1,2,2,0,2,1,2,2
(EvAs)2910·DATA·1,0,1,1,1,2,2,2
(IjAs)2920·DATA·0,1,1,1,1,2,2,2
(KjAu)2930·DATA·0,2,1,2,1,1,2,1
```

```
(DoAu)2940·DATA·1,1,0,2,1,2,2,2·
(DiAj)2950·'
(NqAo)2960·'·Level·data
(GqAk)2970·'
(CpAl)2980·DATA·0
(CxBs)2990·DATA·8,1,10,2,17,3,16,4,15,5,10,6,17,7,16,
8,15
(KtDk)3000·DATA·20,1,0,1,1,1,2,1,3,1,4,1,10,1,17,1,16
,1,15,1,14,0,0,8,1,8,2,0,3,8,4,8,18,8,17,0,16,8,
15,8,14
(DnBp)3010·DATA·8,1,13,2,18,3,15,4,16,5,12,6,17,7,14,
8,18
(PuCr)3020·DATA·16,1,15,2,16,3,17,4,18,5,10,6,17,7,16
,8,15,8,14,7,13,6,12,5,11,4,11,3,12,2,13,1,14
(JxCm)3030·DATA·12,1,18,1,12,2,15,3,15,4,18,4,12,5,18
,5,12,6,15,7,15,8,18,8,12
(PoCs)3040·DATA·16,1,11,1,15,2,11,2,14,3,11,3,13,4,11
,4,12,5,11,5,12,6,11,6,13,7,11,7,14,8,11,8,15
(DpCu)3050·DATA·16,1,18,1,14,2,16,2,12,3,18,3,14,4,16
,4,12,5,18,5,14,6,16,6,12,7,18,7,14,8,16,8,12
(CpDq)3060·DATA·20,1,14,2,13,2,14,2,15,3,11,3,14,4,10
,4,11,4,12,4,17,5,11,5,16,5,17,5,18,6,14,6,17,7,
13,7,14,7,15,8,14
(KjCm)3070·DATA·16,1,0,1,1,1,2,1,12,2,2,2,11,3,10,4,9
,5,13,6,14,7,2,7,15,8,0,8,1,8,2,8,16
(LiAm)3080·DATA·-1
(FiAk)3090·'
(KuAn)3100·'·Ink·data
(FiAk)3110·'
(DxBo)3120·DATA·6,22,8,24,15,17,14,19,7,21,26,14,12,2
3,4,18
(BvAk)3130·'
(FnAv)3140·'·Data·for·m/c·subroutines
(OpAk)3150·'
(MsBn)3160·DATA·21A6C8DD7E004707078007070757E6F0
(HwBp)3170·DATA·5F7AE60F5719DD7E023C075F16001911C3
(CnBp)3180·DATA·61DD7E060707070783DD77067ACE00DD77
(EiBn)3190·DATA·07DD5E04DD56080604C5E513131A4F0600
(BmBl)3200·DATA·1313091A4F0600131309D5E0DD6E06DD66
(BnBp)3210·DATA·0701FF08EDA0E01B17AC6085710F4D1
(KsBk)3220·DATA·E1C110D2C911AAC0DD6E00DD66010613C5
(LiBj)3230·DATA·0808C54ECB01CB01CB010600D5E521
(BvBm)3240·DATA·C361090608C5E0A0E0A0E01FE0709EBC1
(MsBo)3250·DATA·10F2E1D123231313C110D523232323E001
(IpBl)3260·DATA·400009EBC110C9C9DD6E00260029294D44
(MuBn)3270·DATA·2929094D44DD6E02DD660309E511130019
(OrBk)3280·DATA·E0E12BEDB0C921A6C0DD7E0A4707078007
(KtBn)3290·DATA·07070757E6F057AE60F5719DD7E0C3C07
(OxBk)3300·DATA·5F160019DD5E18DD56110604DD7E0EDDE
(MkBk)3310·DATA·08201BDD7E0CDDBE02282430331A1313CB
(DqBl)3320·DATA·57C450611313131310F2C300601A1313CB
(BiBm)3330·DATA·47C450611313131310F2C300601A1313CB
(MjBl)3340·DATA·4FC450611313131310F2C300601A1313CB
(EiBj)3350·DATA·5FC450611313131310F2C30060E5C51A4F
(JrBm)3360·DATA·06000913131A4F0600091B1B0608360023
(JpBo)3370·DATA·36002B7CC6086710F4C1E1C9DD6603DD6E
(CnBq)3380·DATA·022C29294D44292909DD4605DD4E040909
(PuBl)3390·DATA·DD4609DD4E0809DD5607DD5E060604E513
(EtBk)3400·DATA·131A13855F1A138C671A13CB3FC3F856F
(LjBm)3410·DATA·1A138C677EE1B7C010E3DD5601DD5E00EB
(JnAu)3420·DATA·34EB11140019C38E61
(IvAk)3430·'
(JxAr)3440·'·Data·for·blocks
(AxAj)3450·'
(AlAs)3460·DATA·00000000000000000000000000000000
(MiBk)3470·DATA·FFFFFFFFFFFFFFFFFFFFFFFFFFFFFFFF
(HnBo)3480·DATA·0F0F78E178E178E178E178E178E10F0F
(GuBm)3490·DATA·F0F0A5B4D25A5B4D25A5B4D25A5B4D25A5B4
(AtBm)3500·DATA·F0F0F3FCF4F2F5F4F5F4F2F3FCF0F0
(LoBl)3510·DATA·0F0F6F6F5F4F2F4F2F4F5F4F6F6F0F0
(CnBk)3520·DATA·FFFFFFFF9F9F5F5F3F3F3F3F5F5F9F9F7F7F
(FvAj)3530·'
(CnAu)3540·'·Data·for·displaying·title
(MpAk)3550·'
(IrBm)3560·DATA·210070DD5E00DD5601061FC5012A00EDB0
(KpBl)3570·DATA·EB01D6070930040150C009EBC110EBC9
(EiBl)3580·DATA·0,1,2,3,5,6,7,8,9,10,11,12,13,14
(HwBl)3590·DATA·15,23,27,31,39,55,63,111,127,140
(PkBn)3600·DATA·141,142,143,206,207,223,239,255
(LrBo)3610·DATA·7002E72C0600DCE38DC7039C00CE171C6
```

```
(HvBo)3620·DATA·E738E1581CE71C06739C668003718CB000
(KpBj)3630·DATA·CA729C0005CA534065B9C5346D7396671
(IwBn)3640·DATA·DCE7142E72C6628DCE429CA039CD0A9217
(EkBj)3650·DATA·1C6373941595CE19C061B9D20000021947
(MjBj)3660·DATA·0004A740E00004A62C03031CE62C2C7356
(HxB1)3670·DATA·37016374DCE73906861CE591D0D39CE5A9
(MsBo)3680·DATA·9B75162739B111CCB53ED1A9AFA9FCA
(PjBm)3690·DATA·93DB7F8474ADF8FF846D67FE04CE6D56A7
(HjBn)3700·DATA·43818F96A6D1DF3EAA6786EB31CFD5AFC
(OqBp)3710·DATA·A31B643BE7539B63A9D0B94350999A058E
(ArBl)3720·DATA·73619E100DB6D4F3BAC6D6D900A5D4E6D8
(MuBo)3730·DATA·EA74CE86C04E61DD3418EC6D44E3B5AB34
(PjBn)3740·DATA·2EA595D341857239D3419D3419CA239667
(JrBm)3750·DATA·4D06705B51390068DD0BA9C774D0666C8E
(AjBr)3760·DATA·74D0674D067314E739D3419CE6D44E239C
(FtBl)3770·DATA·E742EA739D34199B239D3419D33A1CC339
(GtBp)3780·DATA·CE74D06739B512D8E739D0BA9CE74D0666
(EhBk)3790·DATA·C8E74D06742E532DCE739D3419CE6D4432
(DuBn)3800·DATA·39CE742EA739D341857239D3419D0D04EE
(JkBn)3810·DATA·739CE74D06739B51AD8E739D0BA9CE74D0
(CoBn)3820·DATA·0A2D4E74D06733C7305CE739D3419CE6D4
(KoBl)3830·DATA·01239CE742EA739D343807539D3419CDB6
(IxBp)3840·DATA·40D339CE74D06739B57348E739D0BA9CE7
(FiBn)3850·DATA·4CEB184CE74D06739F5E85AE739D3419CE
(HuBn)3860·DATA·6D7FE239CE742EA739D373965739D3419C
(BkBm)3870·DATA·E45B00239CE74D06739B51D18E739D0BA9
(KjBn)3880·DATA·CE74D060A1CE74D06739A6FACAE739D341
(CpBo)3890·DATA·9CE6D443C39CE742EA739D33F026739D34
(CiBq)3900·DATA·19CE19E9B139CE74D06739B512D8E739D0
(LkBl)3910·DATA·BA9CE74D163A9CE74D067354E1F826739D
(FiBl)3920·DATA·3419CE6D44E239CE742EA739D344EE4739
(MnBk)3930·DATA·D3419CC53976419CE74D06739B51390073
(CxBp)3940·DATA·9D0BA9CE74D0F089CE74D067418E74D067
(BiBr)3950·DATA·39D3419CE6D44E3B5CE742EA739D3413C2
(FiBl)3960·DATA·739D3419D35B9D3419CE6D8EA7399E100C
(MjBo)3970·DATA·2739D3B91CE6D8E8F04CE6D0EA6D9415D9
(PkBm)3980·DATA·06739B63A9CE6786E3B1CE74EE4739B63A
(AoBm)3990·DATA·6C8339B63A99C3B47E139CE6D6EA7399D3
(AnBp)4000·DATA·8064739D3691CE6D6EA9DD4E6D6EA65321
(IhBm)4010·DATA·5E44E7399DD91CE869CE591CE6D7C27399
(FqBn)4020·DATA·DD921B2399DD9163F2C27C39CE653CC739
(HqBo)4030·DATA·56FFF6A739B1FB5CE653CC6784E653CC72
(OqBp)4040·DATA·E9C8F94E7395EA65CE77F1CEAA9CE65A3C3
(JjBk)4050·DATA·395EA65B46195EA65CE1DBED339CE5346D
(LtBm)4060·DATA·738CB00CA739E0B0CE5346D70DCA5346
(JqBo)4070·DATA·D73966705CE738E1581CE00DCE38DC5E81
(NqBn)4080·DATA·A0338E1581CB00CE1581CE71C0E738
```

# MAZE: AN AMENDMENT

We seem to have put one over on everybody who typed in the program Maze, in AA61. The purpose of the game is match all opposite coloured faces.

This is the difficult bit. Well, not difficult, exactly. More like impossible. The game can be made to work, however, by substituting the following data lines:

```
360 DATA 2,3,1,5,6
380 DATA 1,3,2,6,5
400 DATA 2,4,5,3,1
420 DATA 6,5,2,4,1
440 DATA 6,4,1,2,3
460 DATA 5,1,6,4,3
480 DATA 5,4,3,6,2
500 DATA 1,3,5,4,2
520 DATA 1,4,2,5,6
540 DATA 3,2,1,4,6
560 DATA 3,4,6,1,5
580 DATA 2,6,3,4,5
```

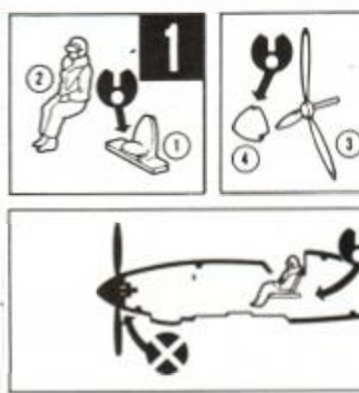

And there you go. You'll be able to finish it now. Thanks to Solus of Devon for these adjustments.



Software for serious sports enthusiasts

# POOLSWINNER II

THE ULTIMATE POOLS PREDICTION PROGRAM



- **MASSIVE DATABASE** Poolswinner is a sophisticated Pools prediction aid. It comes complete with the largest database available: 22000 matches over 10 years.
- **PREDICTS** Not just SCOREDRAWS, but NO-SCORES, ALWAYS and HOMES too. Predictions are based on many factors ... recent form, the massive database, current league standing, goal scoring rates, and draw averages (each factor is independently switchable by the user).
- **SUCCESSFUL** Selec guarantee that Poolswinner performs significantly better than chance.
- **LEAGUE AND NON-LEAGUE** matches are covered.
- **FULL LEAGUE TABLES** are automatically generated as results are entered.
- **FULL PRINTER SUPPORT**
- **AUTOMATIC FIXTURE GENERATION**: Fixtures for English and Scottish League matches are generated automatically by Poolswinner's sister program FIXGEN...

## FIXGEN 1990/91

- No need to struggle for hours to get the fixture list into the computer - just type in the date, Fixgen contains the complete fixture list for the whole year's league soccer. (Published under licence from the Football League, and the Scottish Football League).

£26.50  
Poolswinner with Fixgen.

# COURSEWINNER V3

THE PUNTERS COMPUTER PROGRAM

- The ORIGINAL, and still the BEST computer punter's aid.
- Coursewinner V3 uses all the most important form pointers (past form, speed ratings, prize money, course statistics, jockey form, trainer form etc) to give a detailed assessment of every runner's chances, not just a tip.
- Vital statistics of all British courses (Draw advantage, Top Trainers and Jockeys etc) are included in the database.
- Includes both FLAT and NATIONAL HUNT versions.
- Full Printer support

£24.00

Available for... IBM (5.25", 3.5") Amstrad CPC  
AMIGA BBC  
Atari ST Commodore 64/128  
Amstrad PCW Spectrum

State TAPE or DISC  
(Add £2.00 for Disc).

Send cheque/PO for return of post service to...  
**Selec Software** (Est. 1984)  
62 Altrincham Rd, Gatley, Cheshire SK8 4DP Tel 061-428-7425  
(send for full list of our software) phone 24 hrs

# Dunning COMPUTER SERVICES

(0258) 480660

All prices include delivery - just add VAT at 15%. Cheque with order or phone our credit card hotline before 3pm for same day despatch

Dept. AA, Unit 13C, Sunrise Business Park, Blandford Forum, Dorset DT11 7TE

**NEXT DAY DELIVERY (U.K. MAINLAND)**

## RIBBONS GALORE

We have ribbons for 1000s of printers - if yours isn't listed, give us a call!

	£ per ribbon			
	1	2+	5+	
Amstrad DMP2000/3000	F	3.34	3.17	3.01
Amstrad DMP4000	F	4.70	4.47	4.23
Amstrad 8256/8512	F	3.44	3.27	3.10
Amstrad 8256/8512	MS	3.44	3.27	3.10
Amstrad 9512	F	3.44	3.27	3.10
Amstrad 9512	MS	2.95	2.80	2.66
Amstrad LQ5000	F	5.28	5.02	4.75
Brother M1009/1224	F	3.47	3.30	3.12
Brother M1509/1709	F	4.95	4.70	4.46
Brother M1724	F	7.30	6.94	6.57
Canon 1156A	F	3.73	3.54	3.36
Citizen 120D	F	3.44	3.27	3.10
Citizen Swift 24	F	3.44	3.27	3.10
Commodore MPS801	F	3.34	3.17	3.01
Commodore MPS1230	F	3.43	3.26	3.09
Epson MX/RX/FX100	F	3.95	3.75	3.56
Epson LX80/86	F	2.47	2.35	2.20
Epson FX/MX/RX80	F	3.44	3.27	3.10
Epson LQ600	F	3.64	3.46	3.28
Epson LQ2500	F	4.73	4.49	4.26
Epson LQ2550	F	5.30	5.04	4.77
H.Packard DiJet Cart.		14.80	14.06	13.32
NEC P2200	F	4.95	4.70	4.46
NEC P6+/P7+	F	5.34	5.07	4.81
OKI 390/391	F	4.60	4.37	4.14
OKI 393	F	9.50	9.03	8.55
Olivetti DM100/200	F	3.43	3.26	3.09
Panasonic KXP1080-83				
1090-92, 1124, 1180-90	F	4.00	3.80	3.60
Panasonic KXP1524-40	F	6.90	6.56	6.21
Seikosha SP1200	F	3.44	3.27	3.10
Star LC10	F	3.44	3.08	2.92
Star LC10 4 Col	F	6.86	6.52	6.17
Star LC24-10	F	3.50	3.33	3.15
Star ND/NR/NX15	F	5.71	5.42	5.14
Star NL10	F	5.11	4.85	4.60

F=Fabric MS=Multistrike

## DISKS

	Per 10
3" CF2 Maxell	18.90
3.5" Unbranded DSDD	8.20
5.25" Unbranded DSDD	4.80

## SAVE THOSE RIBBONS!

RE-INK your own black fabric ribbons the new 'ozone-friendly' way. One can of 're-ink' will save you £££s

## CONTINUOUS PAPER

Top quality tractor fed, fanfold	per box	1 2	
		box	box
11x9.5		£	£
60gsm (M)	2,000	16.38	14.88
70gsm (M)	2,000	17.65	16.15
80gsm (M)	2,000	19.30	17.80
90gsm (M)	1,000	13.72	12.22
2 Part NCR	1,000	21.14	19.64
11.66x9.25 (A4 size)			
70gsm (M)	2,000	19.78	18.28
80gsm (M)	2,000	23.28	21.88
90gsm (M)	1,000	15.37	13.87
2 Part NCR	1,000	32.45	30.95

(M) = MICROPERFORATIONS

## COMPUTER LABELS

Avery brand - the best! Tractor fed, fanfold. 1, 2 or 3 across - please specify

	1000	5000
2 3/4 x 15/16	4.25	15.20
2 3/4 x 1 7/16	5.13	18.94
3 1/2 x 15/16	4.55	16.30
3 1/2 x 1 7/16	5.64	22.79
3 1/2 x 1 15/16	8.18	29.99
4 x 15/16	5.34	17.44
4 x 1 7/16	6.39	22.50
4 x 1 15/16	8.19	30.27

Many other labels available including Disk & Laser Labels

# AT OUR PRICES YOU WOULD THINK IT'S CHRISTMAS

## CPC6128 COMPUTERS NOW IN STOCK

All subject to availability RRP WAVE

CPC 6128 & Green Monitor + Joystick + 17 games on disk	£299.99	£249.00
CPC 6128 & Colour Monitor + Joystick + 17 games on disk	£399.99	£339.00
CPC 6128 PLUS MACHINES		
CPC 6128+ & Green Monitor + Keypad + Burning Rubber	£329.99	£310.20
CPC 6128+ & Colour Monitor + Keypad + Burning Rubber	£429.99	£404.20

CARRIAGE ON ABOVE COMPUTERS ANC - 3 DAY £10.35 - NEXT DAY £13.80

## PLUS MODIFICATIONS

6128+ MOD, this gains you the ability to load tape software on the 6128+ DDI-1 MOD, for this we will modify your DDI-1 interface to enable use on a 464+

Both the above modifications requires the item in question to be returned to us plus a covering letter and payment. Modifications are carried out in 7 days.

But please allow up to 21 days for delays in the post!

Please note the modifications will void the warranty and the item in question.

6128+ MOD	£20.00 + £4.60	DDI-1 MOD	£15.00 + £2.30
-----------	----------------	-----------	----------------

## HEROES IN HALF SHELL ARE HERE

### COWABUNGA DUDES

JOIN RAPH, DON, MIKE & LEO ON YOUR CPC!

Teenage Mutant Hero Turtles have hit your CPC	Cassette	£9.09 + £1.15
	Disk	£11.89 + £1.15

## CHRISTMAS SPECIAL £150 GIVEAWAY

JY-3 Joystick	£14.95	GAMES ARE SUPPLIED ON 4 X3" DISKS
17 Games	£150.00	
Discount	£155.00	
Games include: Trivial Pursuits, Monopoly, Cluedo, Scrabble, Scalextric	Total	£9.95 + £2.30 P&P

## THE GREAT CPC COVER-UP!

YES KEEP YOUR CPC 464 UNDER COVER TO ONLY £1.99 + £1.15 P&P  
2 PIECE DUST COVER FOR THE 464, PLEASE STATE MONO OR COLOUR MONITOR

AMSTRAD SUPERCALC 2, DISC FOR CPC & PCW	R.R.P. £69.95	WAVE £24.95+3.45 P&P
AMSTRAD CPC464+ & CPC6128+ Expansion Port Adaptor now available	£11.50+1.15 P&P	

## PRICES SLASHED ONE MONTH ONLY. GENUINE AMSOFT 3" DISCS BOX OF 10 ONLY £15.99 + £1.15 P&P

Star LC10, 9 Pin Printer	£298.85	£151.00 A
--------------------------	---------	-----------

DO YOU WANT TO SAVE MONEY, THEN SEND FOR OUR TRADE PRICE LIST  
STATE FOR WHICH PRODUCTS AND ENCLOSE 3 22p STAMPS

DK 64K Ram Expansion, 464 only	£49.99	£38.99 C	
MP-2 Modulator/PSU	£29.95	£19.99 C	
MP-3 TV Tuner	£69.95	£37.49 C	
DDI-1, 464 First 3" Disc Drive		£159.97 B	
Romantic Robot Multiface 2+	£47.95	£34.76 D	
Romantic Robot Insider - For use with Multiface 2 & 2+	£14.95	£10.47 E	
OCP Advanced Art Studio Disc - CPC	£22.95	£16.07 E	
6128 CP/M Plus System Disk	£22.34	£16.75 E	
CF2 Amsoft/Maxell, EX S/W houses, easy re-formatted + labels	BOX 10	£29.90	£14.80 E
3.50" DS/DD Wabash/Verbatim Bulk + Labels	BOX 10		£4.25 E
Amsoft/Maxell 3" Discs DS/ALL 3" Drives	BOX 10	£29.90	£15.99 E
CPC Centronics Printer Lead		£14.95	£7.48 B
3.50" Disc Drive, State 464 or 6128		£89.95	£75.00 B
CPC to Video lead, state BNC or phono plug		£9.95	£6.99 F
Amstrad Screen Designer, Disk		£49.00	£4.90 D
Amstrad Decision Maker, Disk		£49.00	£4.90 D
40025 Upgrade Rom			£45.00 E

ALL PRICES CORRECT AT TIME OF GOING TO PRESS! OFFERS WHILE STOCKS LAST

PUBLIC NOTICE: POLL TAX - For full details of privileged Tinners exemption - send 5 x 22p stamps. (You can become a privileged Tinner by obtaining 1 share in a Cornish Tin Mine.)

## A SMALL SELECTION FROM OUR WAREHOUSE

ENG. MAINLAND post & ins: (A) £5.75, (B) £4.60, (C) £3.45 (D) £2.30 (E) £1.15 (F) 58p (ANC) 3 Day £10.35, Next Day £13.80, COD+ £2.30, Max. UK post chg. £8.05 per 20kg/£500  
ALL PRICES INCLUDE VAT: All sales subject to our Trade Terms of Trading.  
W.A.V.E. (Trade Dept. AA 9101) Walney Audio Visual & Electrical Distribution  
1 Buccleuch Street, Barrow-In-Furness, Cumbria, LA14 1SR  
Tel: 0229-870000 (6 lines) Hours: Mon-Fri 10.00-5.00



# 1ST CHOICE SOFTWARE LIMITED

for fast friendly service

## EDUCATION

	Tape	Disc
Answer Back Quiz (6-11)	7.45	10.45
(Fact Files for Answer Back Quiz *)		
* 20th Cent. Hist. (12+)	3.70	6.70
* Ass. Football (12+)	3.70	6.70
* Arithmetic (6-11)	3.70	6.70
* English Words (12+)	3.70	6.70
* Gen. Know. (12+)	3.70	6.70
* Gen. Science (14+)	3.70	6.70
* Know England (12+)	3.70	6.70
* Know Scotland (12+)	3.70	6.70
* Nat. History (10+)	3.70	6.70
* Spelling (6-11)	3.70	6.70
* World Geog. (11+)	3.70	6.70
Better Maths (12-16)	8.20	12.70
Chemistry GCSE	10.95	14.95
Donald's Alpha Chase	8.20	10.95
Early Maths (4-8)	6.70	10.95
Early Words (3-6)	6.70	10.95
French Mistress (A+B)	12.70	14.95
Fun School (2-5)	4.45	6.70
Fun School (5-8)	4.45	6.70
Fun School (8-12)	4.45	6.70
Fun School 2 (Under 6)	7.45	9.70
Fun School 2 (6-8)	7.45	9.70
Fun School 2 (Over 8)	7.45	9.70
Fun School 3 (under 5)	9.70	12.70
Fun School 3 (5-7)	9.70	12.70
Fun School 3 (over 7)	9.70	12.70
Geog. Map Quiz (9+)	8.20	12.70
German Master (A+B)	12.70	14.95
Goofy's Railway Express	8.20	10.95
Mickey's Runaway Zoo	8.20	10.95
Micro English (8-17)	17.95	17.95
Micro Maths (8-17)	17.95	17.95
Physics GCSE	10.95	14.95
Primary Maths (3-11)	17.95	17.95
Sooty's Fun Numbers	7.45	10.95
Three Bears (5+) 6128 only	12.70	
Thomas Tank Fun Words	7.45	10.95
Word Hang (5+)	7.45	10.95

## O Level Clearance

Examiner (multiple choice)		
Chemistry	5.95	8.95
Maths	5.95	8.95
Physics	5.95	8.95
Revision		
Algebra/Trigonometry	5.95	-
Geometry/Set Theory	5.95	-

## LEISURE & SPORT

Adidas Cham. Football	9.70	10.95
Colossus Bridge	8.95	10.95
Colossus Chess 4	7.45	10.95
Complete Games Centre	7.45	9.70
International 3D Tennis	7.45	10.95
Kenny Daiglish Soc. 2	7.45	10.95
Kick Off 2	7.45	10.95
Lotus Esprit	8.20	10.95
Oriental Games	7.45	10.95
Tie Break	7.45	10.95

## BUSINESS

Mini Office (Budget)	2.99	-
Mini Office 2	10.95	14.95
Promerge	-	18.70
Prospell	-	16.95
Protext	13.95	17.95
Sprites Alive (Req. 128k)	-	14.95
Sprites Alive + Compiler	-	18.70
Tassign	-	22.45
Tasspell	-	13.95
Tasword464 (or 6128)	17.95	19.95

## ARCADE

	Tape	Disc
Amazing Spiderman	8.20	10.95
Back to the Future 2	8.20	10.95
Beast	9.70	11.95
Dan Dare 3	7.45	10.95
Defenders of the Earth	7.45	10.95
Deliverance	8.20	10.95
Dragon Breed	7.45	10.95
Dragons of Flame	8.20	10.95
Edition One	9.70	13.45
Epyx 21	10.95	14.95
Escape Pl't Robot Mons.	7.45	10.95
Exploding Wall	7.45	10.95
Flimbo's Quest	7.45	10.95
Golden Axe	8.20	10.95
Gun Boat	8.20	12.70
Heroes	10.95	14.95
Hollywood Collection	10.95	14.95
Hostages	7.45	10.95
Klax	7.45	10.95
Mega Play 2 (Light Gun)	7.45	-
Monty Python	7.45	10.95
New York Warriors	7.45	10.95
Nightbreed	8.20	11.95
Pipe Mania	7.45	10.95
Puffy's Saga	7.45	10.95
Puzznic	8.20	11.95
Rainbow Islands	7.45	10.95
Robocop	7.45	10.95
Secret Agent/Sly Spy	7.45	10.95
Sega Master Mix	11.95	18.70
Snowstrike	8.20	10.95
Stunt Car Racer	7.45	10.95
Super Off Road Racer	8.20	10.95
Teenage Mutant H. Turtle	8.95	11.95
Time Machine	7.45	10.95
Total Recall	8.20	11.95
TNT	10.95	18.70
Twin Worlds	7.45	10.95
U N Squadron	8.20	10.95
Untouchables	7.45	10.95
Wheels of Fire	10.95	18.70

## BARGAIN BUYS

After The War	3.99	-
Beyond The Ice Palace	2.99	5.99
City Slicker	2.99	-
Count Down	3.99	-
Crack Down	4.99	-
Cyrus 2 Chess (3D)	3.99	6.99
Dark Fusion	-	5.99
Dragon Spirit	4.99	-
Dr. Who & Mine of Terror	2.99	-
Dynamic Duo	3.99	6.99
Dynasty Wars	4.99	-
E-Motion	4.99	-
Every Second Counts	3.99	-
Firelord	2.99	-
Fire Trap	3.99	5.99
Flunky	2.99	6.99
Fourth Protocol	2.99	-
Future Knight	2.99	-
Galaxy Force	2.99	-
Hard Drivin'	3.99	-
Hopping Mad	3.99	5.99
Impact	2.99	-
Karnov	2.99	5.99
Licence to Kill	3.99	-
Not a Penny More	2.99	-
Pacland	-	7.99
Pyraword	2.99	*
Scramble Spirit	3.99	7.99
Screen Designer	-	4.99
Spl. erical	3.99	7.99
Spitting Image	2.99	-
Sonic Boom	4.99	-
Tetris	2.99	5.99
Thunderbirds	3.99	7.99
Toobin	-	5.99
X-Out	4.99	7.99
*Transfers to disc		
Bargain Buys available while stocks last. New items frequently added.		

## BUDGET

£2.99 TAPES

3D Snooker	
4x4 Off Road Racing	
4 Most Action	
4 Most Horrors	
4 Most Sports	
Action Pack	
Arcade Fruit Machine	
Arctic Fox	
Atom Ant	
Bards Tale 1	
Black Beard	
Buggy Boy	
Cauldron 1 + 2	
Classic Arcadia 2	
Cowboy Kidz	
Double Dragon	
Dr. Scrimers Spook School	
Fantasy World Dizzy	
Fruit Machine Sim. 2	
Game Over	
Gilbert	
Guardian 2	
Guardian Angels	
Hit Pack	
Ikari Warriors	
Indiana Jones	
Las Vegas Casino	
Little Puff	
Mike Reid's Pop Quiz	
Motor Cycles 500	
Official Father Christmas	
Operation Hanoi	
Operation Hormus	
Pegasus	
Postman Pat 2	
Pro Golf Simulator	
Pro Skateboard	
Pro Snooker	
Pub Trivia	
Quattro Advn. (inc. Dizzy)	
Quattro Arcade	
Quattro Combat	
Quattro Power	
Quattro Sport	
Quattro Super Hits	
Question of Sport	
Quik Snax	
Rally	
Rockstar ate Hamster	
Silk Worm	
Skating USA	
Space Harrier	
Spaghetti Western	
Spitfire 40	
Super Kids	
Super Stock Cars	
Supertrux	
Spy Hunter	
The Boxer	
The Wombles	
Thomas Tank Engine	
Thriller Pack	
Time Scanner	
Treasure Island Dizzy	
Turf Form	
Video Card Arcade	
Wacky Darts	
Wonderboy	
Yes Prime Minister	
Yogi and Greed Monsters	
Yogi's Great Escape	
BUDGET	
	£1.99 TAPES
Bomb Jack 2	
Dan Dare	
Dizzy Dice	
Kick Start 2	
Pool	
Periscope Up	
Sailing	
Speed King	
Super Nudge 2000	
Steve Davis Snooker	
Swat	
BUDGET	
	£6.99 DISCS
Archon Collection	
Arctic Fox	
Pegasus	

## Tape £2.99 CHEAT Disc £4.99

Ready to use cheats for your games. (Games not included.)

Disc versions have cheats for both tape and disc games. Tape versions have cheats for tape games only. Cheats work with original games, but may not work with re-released or compilation versions.

### CHOICE CHEATS 1

Cheats for: Advanced Pinball Simulator, By Fair Means or Foul, Cybernoid, Flying Shark, Joe Blade 2, Karnov, Operation Wolf, Radius, Reflex, Shanghai Karate, Star Trooper & Tanium.

### CHOICE CHEATS 2

Cheats for: Arkanoid, Arkanoid 2, ATV Simulator, Batman Caped Crusader, Dragon Ninja, Dynamite Dan, Empire Strikes Back, Head Over Heels, Hopper Copper, Pro Ski Sim., Solomon's Key & Treasure Island Dizzy.

### CHOICE CHEATS 3

Cheats for: After Burner, Big Foot, Robocop, Skweek, Storm Lord, Hit Squad, Thunderbirds, Thunder Blade, Titan, Twin Turbo V8, Yabba Dabba Doo & Yogi Bear.

### CHOICE CHEATS 4

Cheats for: Batman the Movie, Chase HQ, Ghostbusters 2, Ghoul's & Ghosts, New Zealand Story, Operation Thunderbolt, Pacmania, Rainbow Islands, Rick Dangerous, Silk Worm, Untouchables & Xenon.

### CHOICE CHEATS 5

(Contains cheats for budget games only.)  
Cheats for: 3D Pinball, Air Wolf 2, Batman 3D, Bomb Jack 2, Count Duckula, Dragon's Lair, Fantasy World Dizzy, Fast Food Dizzy, Little Puff, Monte Carlo Casino, Paper Boy, Punch & Judy, Renegade, Scooby Doo, Wizard Willy and Wonderboy.

## JOYSTICKS

Mean Green Competition Pro	£12.95
Megablaster	£6.45
Star probe	£13.95
Quickjoy 2	£5.95
Quickjoy 2 Turbo	£7.95
Quickjoy 3 Super Charger	£8.95
Quickjoy 5 Superboard	£14.95
Quickjoy 6 Jet Fighter	£12.50
Konix Speedking	£8.95

## RIBBONS

DMP 2000/3000	£2.75
DMP 4000	£5.75
Epson FX80/RX80	£3.75
Star LC-10 Black	£3.75
Star LC-10 Colour	£5.75
Star LC24-10	£4.75

## RIBBON REFRESH

Fabric Ribbon Restorer  
Re-inks up to 30 ribbons

Only £7.95

## CHRISTMAS SELECTION BOX £25

Choose up to £50 worth of selected software and peripherals for only £25. Send SAE for details.

## BLANK 3" DISCS

Maxell CF2 discs  
£37.95 for 20  
£19.95 for 10  
£10.95 for 5  
£2.35 each  
Amsoft CF2 discs  
£22.95 for 10  
£11.95 for 5

## MAGNUM LIGHT PHASER

Complete with 6 games including Operation Wolf. Only £29.95

## OCP Art Studio

OCP Advanced Art Studio (128K req.)  
Disc £17.20  
Disc + mouse £44.95



HAND HE GAMES  
You can play anywhere

1943  
After Burner  
Back 2 Heaven  
Batman-Fight  
Batman-Video  
Bowling  
Clay Shot  
Combat Attack  
Combat Zone  
Double Dragon  
Double Dribble  
Football  
Formula 1  
Gaurtlet  
Ghost Catcher  
Gradius  
Grand Prix  
Gun Fight  
Indiana Jones  
Karate King  
Karnov  
Knight Rider  
Mouse Maze  
Outrun  
Pinball  
Pinball Wiz. 5 Ski  
Ring King  
River Crossing  
Runaway  
Simons Quest  
Skate or Die  
Space Attack  
Space Battle  
Star Force  
Sub Wars  
Submarine  
Teenage Turtles  
Top Gun  
Vampire Strike  
Vindicators  
GX4000 CARTRIDGE  
Barbarian 2  
Batman Movie  
Crazy Cars 2  
Double Dragon  
Fire & Forget 2  
Operation Thunderbolt  
Robocop 2  
Shadow Warriors

Prices include VAT and P & P. All items subject to availability. Only UK orders please.

To order fill in the coupon or write the details on paper and send it with a cheque or postal order to

1st Choice Software Ltd.,  
Dept AA1, 4 Paul Row,  
Summit, Littleborough,  
Lancashire. OL15 9QG

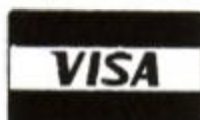

phone 0706 372728

Access and Visa holders can order by phone.

Title

Disc/Cass Price

Name Address

Postcode

Total



# Compumart

ALL PRICES  
INCLUDE V.A.T.

NEW

## LOWER PRICES

### Amsoft

#### 3" CF2 DISKS

- Genuine Amsoft
- Guaranteed Quality and Reliability
- Buy from the UK's LARGEST SUPPLIER

BOX OF FIVE £10.87

BOX OF TEN £19.90

## FREE

AMSCASE 3" STORAGE BOX WHEN YOU SPEND OVER £30!



## NEW LOWER PRICES

### CF-2

COMPACT FLOPPY DISC

### AMSCASE

DISK STORAGE  
CASE - HOLDS  
DISKS

£4.95

### AMS 30L STORAGE BOX

- Can accommodate up to 30 3" uncased disks or 15 3" cased disks

ONLY £9.95



SAVE £5

### LISTING PAPER

7" x 9 1/2" 60gsm  
100 SHEETS

£7.95

200 SHEETS

£14.95

PLEASE ADD £4.00 TOWARDS DELIVERY ON ORDERS FOR PAPER UNLESS YOU ORDER WITH OTHER ITEMS, THEN DELIVERY IS FREE.

24 HR. ORDER HOTLINE 0509 610444

FREE\*  
DELIVERY

(EXCEPT PAPER). ALL GOODS USUALLY DESPATCHED SAME DAY. PLEASE ALLOW 2-5 DAYS

WARRANTY

IF ANY ITEM PROVES FAULTY WITHIN 12 MONTHS OF PURCHASE WE WILL REPLACE OR REFUND.

CUSTOMER SUPPORT

FRIENDLY ADVICE AND AFTER-SALES SUPPORT - ANY PROBLEMS QUICKLY RESOLVED

# Compumart

COMPUMART LIMITED, FREEPOST (AMA)  
JUBILEE DRIVE, LOUGHBOROUGH, LEICS. LE11 0BR  
TEL: 0509 610444 FAX: 0509 610235

SUBS PRICES HELD! SAVE

# BACK ISSUES

FEW IN STOCK, SELLING OUT FAST - GET YOUR

COPIES WHILE THEY LAST!



ISSUE 54 • £1.45  
Comms explained, RSXs laid bare, weather satellites and CRTC chip tips.



ISSUE 55 • £1.45  
Education special, Heart research, Phil Howard takes over Cheat Mode with Myth Mastergame.



ISSUE 56 • £1.45  
Free 'Cheat Mode' book, French scene explored, Mega game series begins.



ISSUE 57 • £1.45  
Joysticks round-up, ECT show report, gallery and TWO Mastergames.



ISSUE 58 • £1.45  
Multi media on the CPC, PC - CPC transfers, Accounts and Fantasy World Dizzy map.



ISSUE 59 • £1.45  
Four Raves and a Mastergame! Naked Video and Blockbuster series concluded.



ISSUE 60 • £1.45  
Amstrad's new console and Plus machines under the microscope. Exclusive analysis.



ISSUE 61 • £1.45  
Fifth birthday issue with cover tape and special boardgame. Iron Lord and Monty Python reviewed.

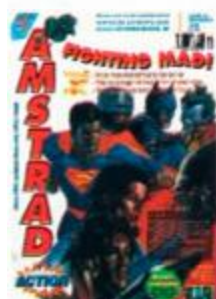

ISSUE 62 • £1.45  
Past, present and future of film tie-ins. Rick Dangerous II Mastergame. CES report.

**SORRY SOLD OUT!**  
ISSUES 1-45, 48-50, 52

### ISSUES STILL AVAILABLE

46 • £1.45

Good book guide, memory expansions explained plus Phil Howard's Insider Dealing and Emma Broadley.

47 • £1.45

Lightgun and its games reviewed, Pandora games writing pack examined.

51 • £1.45

Batman and Powerdrift get the treatment, PC Show report, RSX LIB, Nirvana and Sprites Alive reviewed.

53 • £1.45

EPROMs feature, PD column begins plus an awesome Batmap.

# DON'T MISS OUT!

ABOVE PRICES FOR UK ONLY

OVERSEAS PRICES: EUROPE £5 REST OF WORLD £7

TO ORDER BACK ISSUES USE THE SUBSCRIPTIONS ORDER FORM OPPOSITE.



# FREE GAME

## LOADS OF CHAOS



Lords of Chaos is the magical sequel to Laser Squad, one of AA's all time favourite strategy wargames.



## PIPE MANIA

Incredibly addictive two player plumbing game. You'll never curse a U-bend again!

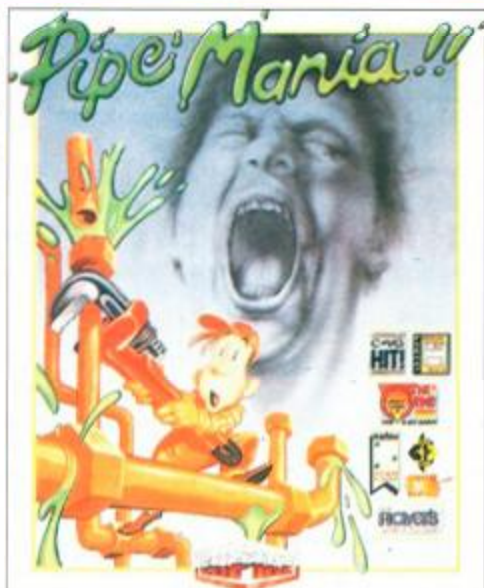

## INTERNATIONAL 3D TENNIS

Tennis at its most realistic. Smashes, lobs and spin all in 3D for a whole season of on court action.

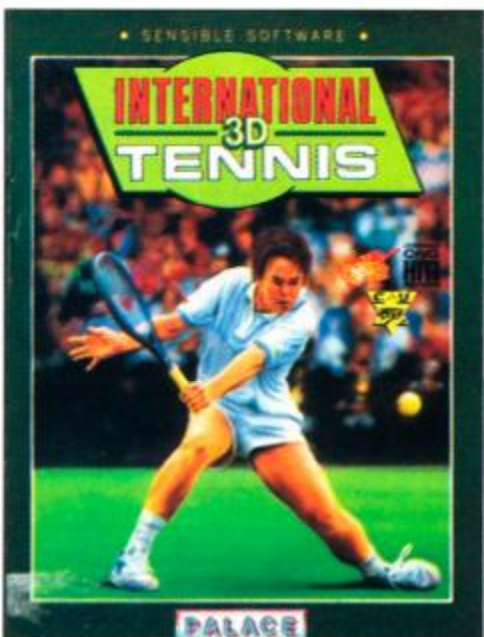

### YOUR NO RISK GUARANTEE

You can cancel your subscription at any time and we will refund you for all unmailed issues.

## WHEN YOU SUBSCRIBE TO AMSTRAD ACTION

### SAVE

the time and hassle of having to collect your copy

### AVOID

the unthinkable possibility of missing an issue

### GUARANTEE

your copy every month, get the most out of your machine and . . . get a free game into the bargain!

## 12 ISSUES OF YOUR FAVOURITE MAGAZINE PLUS A FREE GAME . . . FOR ONLY £19.20!

Makes a whole lot of sense, doesn't it? Don't delay, complete the coupon or . . .

phone our credit card hotline on 0458 74011. . . right now!

**YES!** Please enter/renew my subscription to Amstrad Action and send me my free game.

My choice of game is as follows (please tick one only)

- LORDS OF CHAOS     INTERNATIONAL 3D TENNIS     PIPE MANIA

My choice of subscription for 12 issues is as follows (tick as appropriate)

- UK.....£19.20     Europe .....£34.20     Rest of World .....£49.20

To ensure you get the best possible service all overseas subscriptions are sent Air Mail

Please also send me the following back issues (see opposite page for prices)

(please circle issues required) 46 47 51 53 54 55 56 57 58 59 60 61 62

Name .....

Address .....

.....Post Code .....

My method of payment is (tick your choice) Total payment £.....

- Access/Visa     Cheque (make payable to Future Publishing Ltd)

Card No ..... Expiry date .....

Enclose this coupon (together with your cheque if applicable) in an envelope to:  
Amstrad Action Subscriptions, FREEPOST, Somerton, TA11 7BR





# Codemasters' Chrимbo Compo!



That oh-so-generous budget software house Codemasters has come up with a Chrимbo Compo to blow your socks off!

Last year the Coders offered a brilliant portable CD player to one lucky winner, but this year, three of you – yes, *three* – will be getting a colour hand-held TV!

Shocked? We should think so! To find out more about these fabulous prizes, and how to enter, read on...

built-in headphone sockets mean that you don't get thrown off buses or booted out of Sainsburys for disturbing all those boring types around you.

But what about all those people who say we're only helping to breed a nation of couch potatoes? Rubbish! – thanks to the fabby AA Chrимbo Compo you can be a potato anywhere...



**25**  
CODEMASTERS  
T-SHIRTS FOR  
RUNNERS  
UP

Isn't technology wonderful? With the advent of affordable portable colour tellys now anyone can lock themselves up in their bedrooms watching *Neighbours* (instead of doing their homework, filling in poll tax forms, or writing begging letters to the bank manager, which is what they told the others they were doing). And video recorders mean that you can record all those episodes you missed. (Co-incidentally, you may remember we gave away a portable telly and a video recorder last ish, ahem...)

Well now we are giving you the chance to catch up with your fave proggies on the bus, at the launderette, dangling from the Avon gorge – anywhere even your trusty portable wouldn't get to.

These hand-held TVs we're giving away are slim enough to fit in a coat pocket, yet their high-resolution colour LCD screens give absolutely startling picture quality. They run for hours on a single set of batteries, and their

## CHRIMBO COMPO ENTRY FORM

If you want to stand a chance of winning one of the three hand-held colour TVs we're giving away this Christmas, you've got to answer the following tricky questions (just tick the box next to what you think is the right answer):

- Codemasters is the name of...
  - The UK's leading budget software house?
  - An elite code-cracking intelligence squad from WWII?
  - A firm manufacturing refrigerators in Bogota?
- Which of the following has starred in *Neighbours*?
  - Kylie Minogue
  - Bonzo the Baboon
  - Cecil Parkinson
- What does LCD stand for?
  - Long, Cool Drink
  - A variety of locomotive operating from Crewe
  - Liquid Crystal Display
- Dizzy, the character in Codemasters' long-running series, is based on what item of food?
  - A loaf?
  - An egg?
  - A mutated marrow?
- Every Christmas, "When a child is born" sung by Johnny Mathis makes you...

- Happy?
- Sad?
- Sick? (*This is the right answer – ed*)

6. What's the best thing about Christmas?
- The presents?
  - The food?
  - The *Amstrad Action* covertape? (You'll tick this one if you know what's good for you.)

Right then, once you've ticked the answers, cut out this form and send it (or a photocopy) to:

THE AMSTRAD ACTION CHRIMBO COMPO  
BEAUFORD COURT  
30 MONMOUTH STREET  
BATH  
AVON BA1 2BW

And just so that we know who you are when we come to draw the winners' names out of the AA (bobble) hat, jot down your personal particulars here:

Name .....

Address .....

### THE RULES

- Employees of Future Publishing or Codemasters are not eligible for entry. Neither is anyone else who might be able to sneak into the offices and staple every entry but one to the inside of the hat.
- Multiple entries will not be tolerated. If you want to spend a fortune on stamps it's up to you, but they'll all end up in the bin.
- Closing date is February 28th 1991, so if you don't get your entry form in before then, it's hard cheese!



## ONLY POOLS AND HORSES

Every program written by a mathematician who has spent many years in the betting industry. Programs that utilise the tried and trusted methods of the professional, not pie in the sky theories that fail to pass the test of time.

**FOOTBALL BOXFORM** Written by a former pools expert for Littlewoods. The program has forecast over 50% more draws than would be expected by chance. Homes, aways and draws shown in order of merit and true odds given for every match. Merit tables show at a glance the teams currently in form and those having a lean spell. Australian Pools program included in the price.

**POOLS PLANNER** by the same author. Full details given of 369 easily entered block perms ranging from 9 to 73960 lines and from 12 to 56 selections. All are accepted by the pools firms and are checked in seconds by your computer.

**RACING BOXFORM** Course characteristics (built into the program) as well as the form of the horses are considered in speedily producing an order of merit for each race. Designed for flexibility allowing users to amend the program if they wish. Price still includes the highly acclaimed HANDICAP WINNER - more than 1000 winners every year - over 25% of them at 5/1 or better.

**PRICES** (Tape) £15.95 each. £25.95 any two. £35.95 all three. For discs please add £2 per program. Order two or more and receive FREE a program to work out almost any bet. So good it's used by bookies.



Advertised for six years in the sporting and computer press.

**BOXoft CLEVER..GET THE BEST**

BOXOFT (AA), 65 Allans Meadow Neston,

South Wirral. L64 9SQ. Cheque/P.O./

Access/Visa Tel: 051 - 336 - 2668

BBC B & MASTER  
AMSTRAD PPC & PCW  
COMMODORE 64/128  
SPECTRUMS



# TREASURE ISLAND

1 2 3 4 5 6 7 8 9 10

A									
B									
C									
D									
E									
F									
G									
H									
I									
J									

CASH PRIZES

USE YOUR VOICE TO LOCATE THE TREASURE

# 0898 313 586

Infodial PO Box 36 LS1 4TN Call Charges 33P Per min Cheap Rate 44P all other times

## SPRITES ALIVE

### THE ULTIMATE GAMES DESIGNING SYSTEM

THE IDEAL CHRISTMAS GIFT FOR ALL ASPIRING GAMES CREATORS

Want to write professional looking, fast action games?  
Finding machine code too complex and time consuming?  
Look no further!!

Sprites Alive has been created to enable you to write your own potential master game.

With all of the difficult machine code routines already written for you, all you need is some basic programming knowledge and you can let your imagination run wild!!

Sprites Alive is available in two formats.

**BASIC.** This version adds an extra 70 commands which can be used within your BASIC programs. The Sprites designer software is also included in this package.

**COMPILER.** This version contains all the features of the above package, but also includes the Sprites Compiler program. The compiler will allow your programs to run up to 16 times faster than normal. The BASIC version of Sprites Alive is also included with the compiler package.

#### BOTH PROGRAMS HAVE THE FOLLOWING FEATURES

- Uses simple BASIC commands
- Works in mode 0 or mode 1
- Smooth pixel by pixel movement
- True collision detection
- Comprehensive 75 page manual
- Sprite sizes up to 32x32
- 23k program space available
- No machine code required
- Joystick/Keyboard control
- Automatic missile commands
- Automatic direction animation
- Automatic maze modes
- 64 super smooth sprites
- Excellent drawing designer
- 70 commands added to BASIC
- 6 BASIC demo programs

#### COMPILER FEATURES

- Up to 16 times faster than BASIC
- Up to 10 times faster than Pandora
- 2 additional compiler demos
- No machine code needed
- Simple to use
- Comprehensive manual

If you can program in BASIC you can use Sprites Alive

**BASIC VERSION..... WAS £22.95..... SPECIAL OFFER..... £18.95**  
**COMPILER VERSION..... WAS £29.95..... SPECIAL OFFER..... £22.95**  
**COMPILER DEMONSTRATION GAME DISK \*..... 4 GAMES..... £2.99**  
**UPGRADE FROM BASIC VERSION TO COMPILER VERSION..... £4.50**  
 (return system disc with cheque)

Suitable for CPC6128 or CPC464 with 64k Memory Expansion  
Supplied on disc only

\* This demonstration disc shows some of the vast capabilities of the Sprites Alive Compiler. Includes 'Space Froggy' by Gary Scott - (outstanding arcade type action game)

We are so confident you will be amazed at the capabilities of Sprites Alive, we are now offering a 28 day money back guarantee period on all Sprites Alive packages purchased directly from Glenco Software.

Please make cheques/postal orders payable to Glenco Software

**GLENCO SOFTWARE, DEPT AA,  
15 ALFORD LANE, WHITEHOUSE FARM,  
STOCKTON ON TEES, CLEVELAND TS19 0QP  
TELEPHONE: (0642) 606358**

## ON DISK

for CPC 6128 or CPC464+DD1

# Cluedo Monopoly Scrabble Trivial Pursuits

**Plus a DOZEN more  
great games**

**Plus FREE JY3 Joystick  
worth £9.99  
with every order**

**Worth £150  
when  
purchased  
separately**

**Only  
£14.99  
+ £2 Carriage & Ins**

**ALL MAIL ORDER to :-**

*Software Superstores*  
7A Oldham St.  
Hanley,  
STOKE -ON-TRENT.  
ST1 3EY.



**ORDER HOTLINE :- 0782-204639**

**Many other Amstrad bargains in store at**

*Software Superstores in:-*

<b>SHEFFIELD</b>	6 Waingate	0742-721906
<b>STOCKPORT</b>	6 Mealhouse Brow	061-480-2693
<b>ST HELENS</b>	27 Baldwin Street	0744-27941
<b>HANLEY</b>	Market Square Arcade	0782-268620
<b>WARRINGTON</b>	The Courtyard 50 Horsemarket St	0925-232047

AA/JAN



# Cheat Mode

How does that man Phil Howard do it? Another huge wodge of tips...



Blimey, Crikey, Golly, Gosh, and other expletives you've come to expect from the AA team (they really talk like that!), it's the night before Christmas (c'mon use your imagination) and all through the house not a creature is stirring, not even a mouse. High above the rooftops, an old boy in red jets chimneyward clutching GX 4000 consoles for you, bottles of fizzy plonk for me. Snowflakes fall, and the earth shines crisp and white under

a pale winters moon. Somewhere in the cold distance, cheered by the ochre glow of a single candle lit lantern, and the yuletide spirit, carolers sing:

*"The boys of the NYPD choir were singing Galway Bay  
And the bells were ringing out for Christmas day"*  
Well..., it beats sending out 35,000 cards! - Happy Christmas everybody. (What is all this? - ed)



## Spooky Castle

Glamis Castle, near Forfar in Scotland is the most haunted castle in Britain! Reputed to be the real life setting for Shakespeare's Macbeth, in its time has seen many an evil deed. In addition to a hosts of stories concerning ghouls and ghosties, is a legend of a secret "forbidden" room hidden among the towers which holds dark and horrific memories from the past, but its location remains a mystery... All this has absolutely nothing to do with Graham Smith's tape poke for *Spooky Castle*, by the way.

```
(OnAs) 1.'Spooky Castle...tape-
(HvAq) 2.'By Graham Smith
(EwAs) 3.'Infinite lives
(FtAj) 4.'
(LiAu) 10·DATA·06,00,11,52,5d,cd,77
(OiAv) 20·DATA·bc,21,fc,00,22,d0,5d
(JkAv) 30·DATA·c3,71,5d,af,32,0a,09
(CnAs) 40·FOR·j=0·TO·20:READ·a$
(KpAs) 50·x=VAL("a"+a$):y=y+x
(LvAr) 60·POKE·j+235,x:NEXT·j
(FwAv) 70·IF·y=1975·THEN·CALL·235
(BjAq) 80·PRINT"data·error"
```

● Multiface poke for Spooky Castle

Address = 090A  
Poke = 00



## Tetris

Long ago in a galaxy far away Bobby Wade (who?) complained that there was no pause facility for the Mirrorsoft game *Tetris*... Well, no sooner (?) said than done. Marcus Fletcher of Carlisle has produced a poke which gives you just that, a breather from the hectic pace of that game. It is specifically for the *Supreme Challenge* disk but may work on others. Press TAB to pause, any other key to restart.

```
(GvAl) 5·IDISC
(IsAr) 10·OPENOUT·"V":MEMORY·&FFF
(JkBl) 20·PRINT·"PUT·IN·GAME·DISC,
PRESS·A·KEY"
```

```
(JlAp) 30·CALL·&BB18
(KmAr) 40·LOAD·"CONTROL",&1000
(BkAs) 50·LOAD·"AMSCODE.BIN",&3000
(CuAt) 60·LOAD·"GAMESCR.SCR",&5000
(PxAn) 70·CLOSEOUT
(MnAt) 75·POKE·&1B83,ASC(" ")
(IqBx) 80·FOR·I=&1B84·TO·&1B8B:READ·A$:POKE
·I,VAL("a"+A$):NEXT
(ETAt) 90·DATA·CC,18,BB,0,0,0,0,0
(NvAn) 100·CALL·&1000
```



## Live and Let Die

Licensed to cheat, Graham (0A7 - hackers' talk) Smith saves Queen and country from endless frustration with this tape poke for the game of the film of the book, *Live and Let Die*. James Bond, could you do this?

```
(HlAr) 1.'Live and Let Die
(HvAq) 2.'By Graham Smith
(PTAr) 3.'Infinite fuel
(KxAs) 4.'Infinite missiles
(HoAq) 5.'Tape...method·1
(FvAj) 6.'
(XsAt) 10·DATA·af,67,6c,22,01,74
(FxAv) 20·DATA·32,95,74,c3,fd,05
(MsAu) 30·DATA·21,fe,a3,22,57,a4
(CoAs) 40·FOR·j=0·TO·17:READ·a$
(KpAs) 50·x=VAL("a"+a$):y=y+x
(HpAs) 60·POKE·j+41982,x:NEXT·j
(CuAr) 70·IF·y<2040·GOTO·100
(GrAs) 80·MEMORY·33333:LOAD"
(IoAp) 90·CALL·41994
(OsAp) 100·PRINT"data·error"
```

● Multiface pokes for Live and Let Die

Address	Poke	Effect
7495	00	Inf fuel
7401	00	Inf missiles
7402	00	

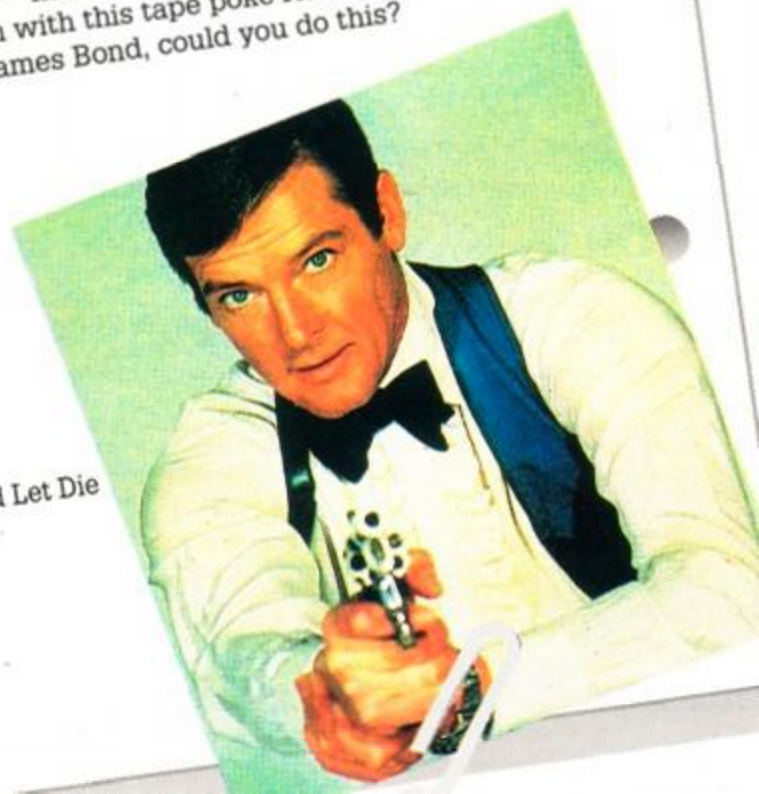





# Stunt Car Racer

**Stunt Car Racer** on disk by John Girvin of Belfast gets the treatment here, with infinite boost and invulnerability. I liked the Obi-Wan-Waring thingy in AA62 John, I may use it myself one day... when everyone has forgotten of course (where do you think I get my ideas from?).



```
(KsAt) 1.'STUNT-CAR-RACER-hacks
(LnAp) 2.'By-John-Girvin
(IkAo) 3.'August-1990
(FtAj) 4.'
(LmAv) 10-MODE-1:CALL-ABC02:PEN-1
(MuAp) 20-addr=ABE00:RESTORE
(BkAo) 30-READ-byte$
(HtB1) 40-IF-byte$="VAROOM" THEN-GOTO-70
(CxAs) 50-POKE-addr,VAL("&"&byte$)
(FiAr) 60-addr=addr+1:GOTO-30
(ErBu)
70-PRINT-"Insert-STUNT-CAR-RACER-disc-and-press-a-k
```

```
ey..."
(LmAv) 80-CALL-ABB18:CALL-ABE00
(IjAs) 90.'***-LEAVE-100-160-IN-***
(IoBk) 100-DATA-21,b0,be,cd,d4,bc,22,b1
(LkAu) 110-DATA-be,79,32,b3,be,21,00,01
(CqAx) 120-DATA-0e,41,11,00,00,df,b1,be
(HvAx) 130-DATA-21,a7,be,22,0c,01,c3,00
(OsAu) 140-DATA-01,a4,48,4c,46,08,5a,21
(DtBi) 150-DATA-b4,be,22,7b,80,c3,09,80
(XpAp) 160-DATA-84,00,00,00
(JrAr) 170.'Infinite-Boost
(BpAs) 180-DATA-af,32,77,21
(NuAp) 190.'Invulnerability
(KvAt) 200-DATA-3e,c9,32,c3,98
(JxAs) 210.'***-LEAVE-220-IN-***
(JlAu) 220-DATA-c3,40,00,VAROOM,4a
```

● Multiface pokes (lets hope they are OK!) for *Stunt Car* disk

Address	Poke	Effect
2177	00	Inf. boost
98C3	C9	Invuln.



# Tau Ceti

Straight off the cover of AA61 is the free game *Tau Ceti*, pulled to pieces by Stephen Troup of Kings Lynn. Select which poke (or all of them) you want, and go out blasting. Brighten up your world with infinite flares.

```
(KjAo) 10-REM-Tau-Ceti
(JmAr) 20-REM-AA-Cover-Tape
(LiAl) 30-MODE-1
(HiAm) 40-BORDER-0
(EuBj)
50-INX-0,0:INX-1,11:INX-2,26:INX-3,24
(AqAm) 60-PAPER-0
(JsAm) 70-OPENOUT"D"
(HpAp) 80-MEMORY-1529
(GjAo) 90-CLOSEOUT
(PxAr) 100-WINDOW-4,36,21,24
(DvAm) 110-PEN-1
(ClAp) 120-LOAD"!TITLE"
(PqAm) 130-CALL-2000
(ExAo) 140-LOAD"!PART1"
(PiAm) 150-LOAD"!PART2"
(HlBn)
160-POKE-&4FF2,&A7:REM-Infinite-Flares
(CnBn)
170-POKE-&4FC0,&A7:REM-Infinite-Missles
(EiB1)
180-POKE-&5025,&A7:REM-Infinite-Amm's
(IkAm) 190-INX-1,20
(MxAo) 200-CALL-&88BB
```

● Multiface pokes – see listing

# Quattro Combat

Andy Price has been busy again, this time putting together a poke for Codemasters' *Quattro Combat* compilation. The cheat works on three of the four games on the tape – *Death Stalker*, *SAS Combat Simulator*, and *Arcade Flight Simulator*, so even though it's a bit long you get three for the price of one. You may be asking "So where's the *Ninja Massacre* cheat?", well, the inimitable Adam Waring can supply you with that, seeing as he wrote it (Not bad, Ad!). There are password entries to every 5th level – a lot better than a poke...!



5) RAIN 10) PINK 15) YEAR 20) ROCK 25) WARD 30) HULL 35) STAG 40) BEER

```
(GvAx) 1.'Quattro-Combat-Cheat-System
(GwAr) 2.'by-ANDY-PRICE
(JnAs) 3.'*use-Typewriter-codes*
```

```
(FtAj) 4.'
(AnAr) 10-FOR-x=ABE00-TO-ABE21
(GtAt) 20-READ-p$:p=VAL("&"&p$)
(KsAp) 30-POKE-x,p:NEXT
(NnAv) 40-MODE-1:PRINT"Choose-Game:"
(JrAu)
50-PRINT"1.-Death-Stalker"
(OuAs)
60-PRINT"2.-SAS-Combat-Sin"
(GrBi) 70-PRINT"3.-Arcade-Flight-Sin"
(EnAt) 80-PRINT:INPUT"Number: ",n
(HoAr) 90-ON-n-COSUB-100,100,200
(JvAs) 91-RESTORE-440:GOTO-500
(JjAt) 100-RESTORE-400:GOSUB-290
(JnAt) 110-INPUT"Ground-ghouls";y$
(LvBj) 120-IF-LEFT$(y$,1)="y" THEN-160
(MnAv) 130-INPUT"Fireball-demons";y$
(BlBj) 140-IF-LEFT$(y$,1)="y" THEN-170
(MlAm) 150-RETURN
```

```
(LiAt) 160-POKE-ABE24,&3C:GOTO-130
(NwAt) 170-POKE-ABE29,&3C:RETURN
(NiAt) 180-RESTORE-300:GOSUB-290
(AtAm) 190-RETURN
(MuAu) 200-RESTORE-420:GOSUB-290
(OmAv) 210-CLS:PRINT"Infinite-lives:"
(DnAr) 240-INPUT"Player-1";y$
(FwBi) 245-IF-LEFT$(y$,1)="y" THEN-260
(HxAr) 250-POKE-ABE24,&3D
(BjAr) 260-INPUT"Player-2";y$
(OqAx) 265-IF-LEFT$(y$,1)="y" THEN-280
(DwAp) 270-POKE-ABE29,&3D
(DkAm) 280-RETURN
(NqAr) 290-FOR-x=ABE23-TO-ABE2E
(BlBi) 300-READ-p$:POKE-x,VAL("&"&p$)
(XoAm) 310-NEXT:RETURN
(MrAs) 320-DATA-ED,5B,38,BD,EB
(CrAu) 330-DATA-22,34,BE,11,37,BD
(PnAt) 340-DATA-EB,3E,C3,77,23,3E
(OvAu) 350-DATA-23,77,3E,BE,23,77
(BiAu) 360-DATA-21,40,00,E3,11,00
(AtAt) 370-DATA-BB,00,C3,4A,3A,91
(AuAt) 380-DATA-AF,32,AA,49,3E,FF
(InAv) 390-DATA-32,86,32,32,8B,32
(CvAu) 400-DATA-3E,00,32,1C,17,3E
(IrAr) 410-DATA-00,32,BD,18,00,00
(PtAu) 420-DATA-3E,00,32,8A,89,3E
(PwAt) 430-DATA-00,32,4E,89,00,00
(MpAs) 440-DATA-00,41,50,00,CF,00
(GoAt) 500-FOR-x=ABE2F-TO-ABE34
```

```
(MtAx) 510-READ-p$:POKE-x,VAL("&"&p$)
(HpAr) 520-NEXT:MEMORY-&3000:LOAD
(BnAp) 530-CALL-ABE00
```

● Multiface pokes:

Address	Poke	Effect
---------	------	--------

SAS Combat Simulator		
49AA	00	grenades
3286	FF	lives
328B	FF	demons

Death Stalker		
171C	00	ghosts
18BD	00	demons

Arcade Flight Simulator		
9D12	00	lives (1)
9CD6	00	lives (2)



## Hostages

Fresh from Casualty, Dr. Mike Wong is back again with a bit of surgery on the Infogrames disk game *Hostages*.

His diagnosis is that you ought to be able to play the second part of the game without having to mess about with the first, and his prescription for difficult games? Take *Cheat Mode* once a month!

{AsAq} 1-'HOSTAGES'--disc  
 {NqAs} 2-'128K-only-(sorry!)'  
 {PwAw} 3-'Quickstart-(Bypass-Lvl-1)'  
 {CuAv} 4-'Press-Fire-to-activate'  
 {MvAp} 5-'By-Mike-Wong'  
 {FvAj} 6-'  
 {CjAt} 10-MODE-1:-FOR-n=80-T0-8D2  
 {NuAt} 20-READ-aI:a=VAL("A"+aI)

{PoAt} 30-POKE-n,a:c=c+a:NEXT  
 {IiAt} 40-IF-c(<)5518-THEN-210  
 {OnBi} 50-PRINT-"Insert-Hostages...(!)"  
 {KjAu} 60-CALL-8BB18:CALL-800  
 {HjAt} 70-DATA-21,00,01,e5,11,00  
 {FvAu} 80-DATA-00,0e,41,df,ce,00  
 {FnAt} 90-DATA-21,93,00,22,2f,01  
 {GkAs} 100-DATA-c9,cd,be,02,21,9f  
 {PpAs} 110-DATA-00,22,a7,10,c3,11  
 {CmAv} 120-DATA-01,21,ad,00,11,ac  
 {EnAv} 130-DATA-37,01,21,00,ed,b0  
 {LjAt} 140-DATA-c3,63,b3,21,03,05  
 {HqAu} 150-DATA-36,01,23,36,02,23  
 {PsAt} 160-DATA-36,03,3e,02,32,14  
 {LwAt} 170-DATA-05,3e,0b,32,5e,05  
 {KpAu} 180-DATA-3e,05,32,39,05,0e  
 {LrAt} 190-DATA-03,1e,00,c3,d4,37  
 {JnAr} 200-DATA-3c,e0,07,53,50  
 {BkAs} 210-PRINT-"Error..."

## OPERATION THUNDERBOLT

Look out, here come a bunch of tips on *Operation Thunderbolt* from Master games player and deceivers diarist Stephen Troup of Kings Lynn.

- Try to use as little ammo as possible, as it may cause your death if you run out.
- Only use rocket grenades when really necessary, or when there are too many enemy soldiers.
- To rescue the hostages on levels 4 and 6, shoot the door handles/locks. The door will open and the hostage appears to the right. When all 8 hostages have been released on each of the two levels, no more will appear, but all the doors will be closed.
- On three levels (ones where the hostages appear) there are end-of-level guardians.

The first (level 4) uses a machine gun, the second (level 6) uses a rocket launcher, and the final (level 8) uses a machine gun, but is also holding the pilot in front of him. The first two can be killed easily with the machine gun, or by using 3 rocket grenades. The last level is very difficult and must be shot precisely using your gun – the rocket will kill the pilot also. Only shoot the terrorist's head, as it is his most vulnerable part and easiest to hit. Shoot right to left (the sound will change when he is actually hit). Be very careful not to hit the pilot – you only get one chance.

- At the start of level 8, hoard magazines and use up all your rocket grenades to avoid using them, and killing the pilot, later on. Only shoot the hand grenades, as, if you hit the hostages, precious energy, needed for the end of level will be lost.

{FvAp} 1-'RASTAN-Hit-Squad'  
 {MvAp} 2-'by-Andy-Price'  
 {PxAs} 3-'More-lives-than'  
 {CiAq} 4-'you-can-use'  
 {AoAs} 5-'M2-poke:8D77,lives'  
 {FvAj} 6-'  
 {BvAt} 10-DATA-21,16,BD,36,C3  
 {MjAq} 20-DATA-23,36,0E,23,36  
 {GnAu} 30-DATA-BE,CD,36,99,21  
 {ApAt} 40-DATA-17,BE,22,46,A5  
 {PvAr} 50-DATA-C3,08,A5,DD,21

{CmAt} 60-DATA-B1,A7,11,00,01  
 {BvAq} 70-DATA-CD,40,A7,21,2A  
 {MoAs} 80-DATA-BE,22,5A,A8,C3  
 {KwAs} 90-DATA-DB,A7,3E,FF,32  
 {AwAs} 100-DATA-1D,2C,C3,22,48  
 {PnAs} 110-MEMORY-8FFF:LOAD"!'  
 {InAq} 120-FOR-a=8BE00-T0-8BE31  
 {LkAv} 130-READ-bI:b=VAL("A"+bI)  
 {KjAr} 140-POKE-a,b:c=c+b:NEXT  
 {LpAu} 150-IF-c(<)5101-THEN-100  
 {PuAq} 160-INPUT"No.-Lives";cn  
 {ItAv} 170-POKE-8BE2B,cn:CALL-8BE00  
 {HnAr} 180-PRINT"DATA-error"

- Multiface poke for Rastan

Address = 2C1D    Poke = Number

## Thunderbirds

This poke for tape version of *Thunderbirds* by Stephen Troup of Kings Lynn, gives you infinite

time. Your part of the deal is to select which level you are going to load, and then delete the lines which you don't need (not too difficult is it?) Just as a further bit of help, the passwords are:

Level 2) RECOVERY : Level 3) ALOYSIUS :  
 Level 4) ANDERSON

{OqAq} 10-REM-Thunderbirds  
 {FnAr} 20-REM-Infinite-Time  
 {NlAr} 30-MODE-1:OPENOUT"D"  
 {JiAo} 40-MEMORY-81000  
 {JvAn} 50-CLOSEOUT  
 {JvAo} 60-LOAD"!.,81100  
 {LtAp} 70-FOR-a=80-T0-8A2  
 {ClAv} 80-READ-bI:b=VAL("A"+bI)  
 {JqAn} 90-POKE-a,b  
 {IxAk} 100-NEXT-a  
 {JiAo} 110-CALL-800  
 {IrBj} 120-DATA-01,FE,01,21,00,11,11,00  
 {MtAx} 130-DATA-01,ED,B0,3E,CD,21,99,00  
 {AtAu} 140-DATA-32,35,02,22,36,02,C3,00  
 {BiAp} 150-DATA-01,3E,A7  
 {BwAt} 160-REM-Pokes-only-select-one  
 {DoAq} 170-REM-Level-One

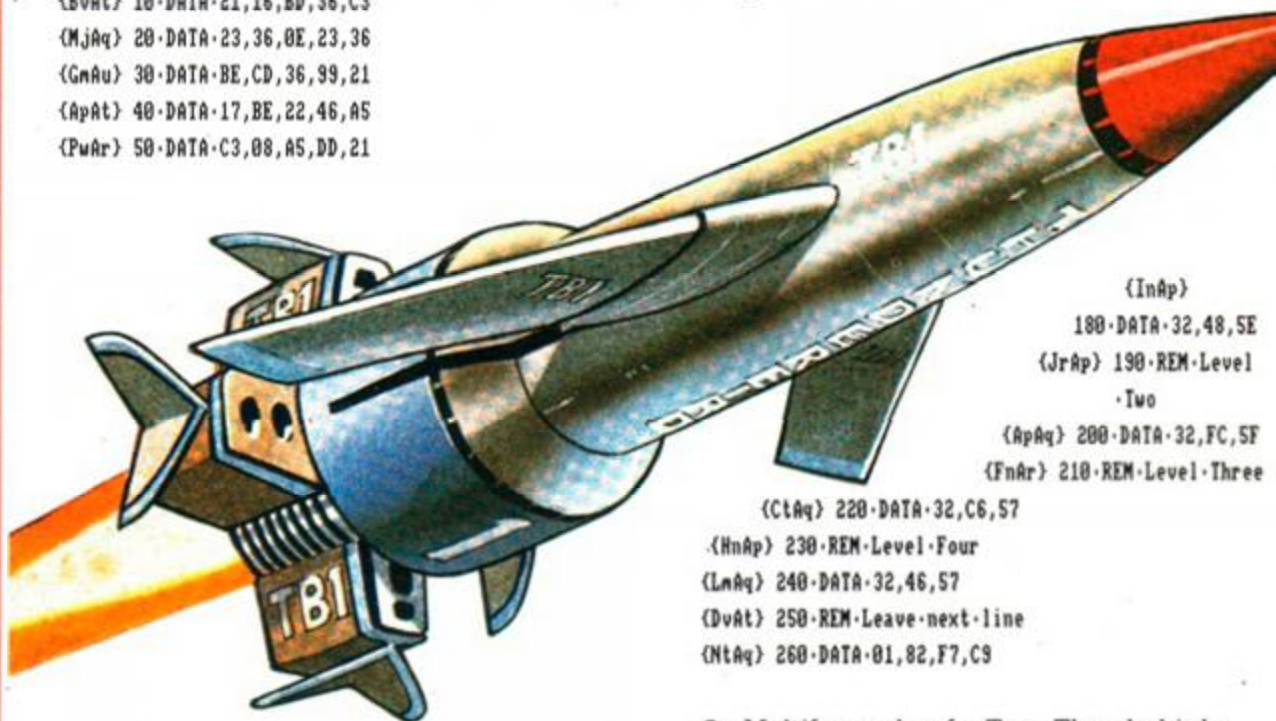

{InAp} 180-DATA-32,48,5E  
 {JrAp} 190-REM-Level-Two  
 {ApAq} 200-DATA-32,FC,5F  
 {FnAr} 210-REM-Level-Three  
 {CtAq} 220-DATA-32,C6,57  
 {HnAp} 230-REM-Level-Four  
 {LnAq} 240-DATA-32,46,57  
 {DvAt} 250-REM-Leave-next-line  
 {NtAq} 260-DATA-01,02,F7,C9

- Multiface pokes for Tape Thunderbirds

Address	Poke	Effect
5E48	A7	level 1
5FFC	A7	level 2
57C6	A7	level 3
5746	A7	level 4

## Rastan

The game with 255 levels gets 255 lives, or however many you want, The Hit Squad's *Rastan* tape falls to the cunning cleverness of the Rastanman, Dunstable's own Andy Price.

## Dan Dare 3

*Dan Dare 3* the latest offering from Virgin has been looked at by Stephen Troup of Kings Lynn: Go to the Store and use up all of your ammo, you then get 4,000 credits to spend on whatever

HANDS UP, YOU HORRORS!



er you want. This works at any point in the game.





# Continental Circus

Ok! so do you remember this? Some time ago we did the disk version of the same cheat. Then the month after, you were supposed to get this tape version for *Continental Circus*, but for some reason Rod cut it out! (he's a bit like that!).

Anyway, undeterred, here it is again - If he cuts it out this time you'll never know, but more importantly, will you care?

(CxAg) 1 - Continental Circus  
 (HlAn) 2 - Tape Poke  
 (FrAs) 3 - Infinite Continues  
 (FtAj) 4 -  
 (CnAt) 10 - DATA 21,16,bd,36,c3,23  
 (HkAt) 20 - DATA 36,0e,23,36,be,c3  
 (JqAr) 30 - DATA 0a,9b,21,17,be,22  
 (EuAu) 40 - DATA 26,a4,c3,10,a4,dd  
 (MlAu) 50 - DATA 21,c4,a9,11,8f,00  
 (DnAu) 60 - DATA cd,1f,a6,21,2a,be

(NqAt) 70 - DATA 22,51,aa,c3,ee,a9  
 (PoAu) 80 - DATA 21,50,00,22,05,01  
 (XqAu) 90 - DATA 21,3e,be,11,50,00  
 (NjAs) 100 - DATA 01,07,00,ed,b0,c3  
 (DlAu) 110 - DATA 00,01,af,32,63,27  
 (LsAp) 120 - DATA c3,00,04  
 (NqAp) 130 - y=0:MEMORY AS000  
 (IiAs) 140 - FOR x=ABE00 TO ABE44  
 (LnAt) 150 - READ af:a=VAL("A"+af)  
 (NsAt) 160 - POKE x,a:y=y+a:NEXT  
 (HpAt) 170 - IF y(<)#17FB THEN 200  
 (JpAo) 180 - LOAD "circus"  
 (HjAo) 190 - CALL ABE00  
 (EnAr) 200 - PRINT "data error!"

● Multiface poke for Tape Continental Circus

Address = 2763 Poke = 00

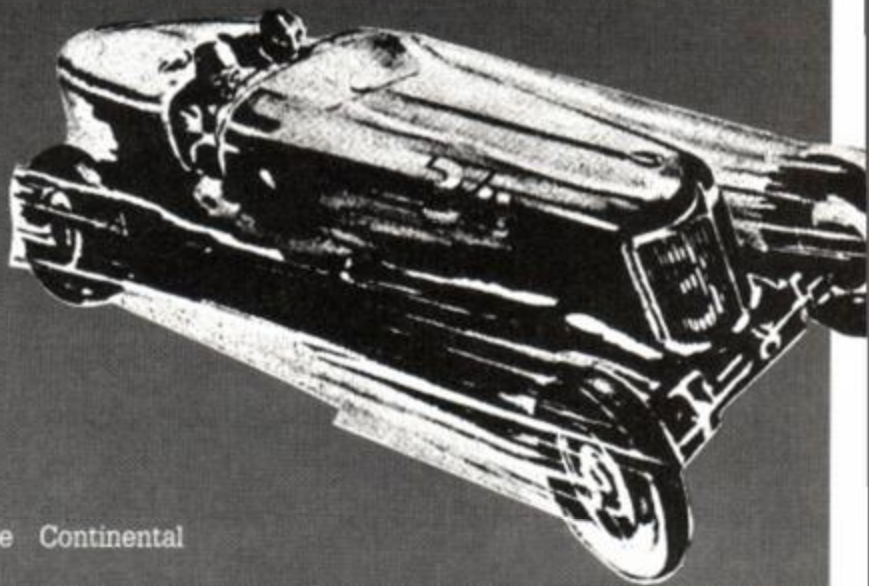

## Satan

Stuck in the spectral caverns of Dynamic's *Satan*? Find your way out with the password to level 2 - 01020304.

## Ghouls 'n' Ghosts

Carl (Ebenezer - we've already done that!) Surry of Barnet has provided a little tip for *Ghouls 'n' Ghosts*: On the first screen, if you go to the extreme left and jump in the air, a secret chest will appear. (Not Maria Whittaker's, by the way - that never was much of a secret!)



## Bloodwych

After many hours wandering around (not totally aimlessly) in *Bloodwych*, Greg Lee of Sharples in Bolton has produced some tips to help you on your way. Those monsters aren't all that bad, they just like a good brawl:

- Conversation: When you first meet a monster, offer him one gold piece. When he accepts, press the exchange icon, if you now want the object offered, press the yes icon.
- If you are short of money, continue and repeat as above. The monster will now offer an empty slot. Take it, and try to get another gold piece from your chappie. If you look, some money will have materialised in your transfer slot. This is now yours. Repeat until you have enough.
- For more keys or arrows, try exchanging an arrow or a key with the monster, and accept what he gives, empty slot or not. Continue until you have enough. Note: keys are more common.

- If you are short of food, exchange 1 gold piece with the monster, then another gold piece. The second time, the monster exchanges your money for 1 gold piece. Then do as though you had just met the monster, i.e. offer 1 gold piece, exchange, and the monster offers food.
- When selecting characters at the beginning of the game, make sure you have a fighter, a Mage and an Assassin (an Adventurer does not seem much use). Thai Chang is probably the best Assassin, Murbock the best Mage and Ulrich the best Fighter.
- Fighting: Give your Assassin a bow and arrows and put him on the back row with the Mage. On the front row, put your fighters with the best weapons and armour. If possible, give them armour spells.
- Only fight monsters in rooms 2x2 or bigger, and on twisting corridors leading to a room. Take groups of monsters on only one at a time, and never stand and face them whilst fighting to the death, always attack

from the side. This is more important later when they start chucking spells at you.

- In big rooms, where there are 2 or more monsters, make sure that you don't get cornered, and fight while retreating. If things get too hot then get out, the way you came in preferably, and lock the door behind you, then go to sleep. Try to save the game before entering these areas as they tend to be a bit dodgy.
- Before going to sleep, make sure it is not in a cul-de-sac (a corridor with no room at the end) as it may turn out to be a DEAD end when you are discovered by a monster and are trapped!
- Potions found have the following effect:
  - Moonelix - Spell points.
  - Dragon Broth - Vitality
  - Snake Slime - Hit points
  - Brimstone ale - The lot
- Make sure you don't leave a section until you have done everything there is to do.





# MULTIFACE POKES

Cloistered again, Carl (Ebenezer) Surry of Barnet thumbed through his hoard of Multiface pokes, "Six billion and seven, and eight...", the midnight clock disturbed his count. "Bah!, Humbug!" he muttered, "Christmas!". No sooner had the word fallen from his lips, than a mysterious chinking and clanking of chains echoed along the hallway and stopped dead outside his door. Carl watched in horror, as a ghostly arm reached through and grabbed a handful of the precious pokes...

NAME	ADDRESS	POKE	EFFECT
Bubble Ghost	(t) 82A4	00	Inf. bubbles
Hydrofool	(t) 7575	C3	Stops rust
Uridium +	(t) 1FC2	00	Inf. lives
		0962	no homing
		0963	missiles..
		0964	all 3 pokes
Tiger road	(d) 56F1	00	Inf. lives
Molecule man	(t) 9EBD	00	Inf. time
Gryzor	(d) 1526	A7	Inf. lives
Antiriad	(t) 5749	00	Gives boots
		64F4	Gives guns
Prohibition	(t) 0FB1	B7	Inf. hide time
		0B69	Inf. lives
		198E	No shooting back
Operation Hanoi	(t) 8AB3	A7	Inf. ammo
		8ACF	Inf. grenades
		8F0E	Inf. lives
TLL	(t) 917A	00	Inf. lives
		A6A2	Inf. fuel
		909B	Inf. time..
		909C	do both
		A8C8	Inf. bombs..
		A99B	do both
Renegade	(t) 0FB8	FF	Stay on platform
Renegade	(d) 0FE1	FF	Stay on platform
Flying Shark	(t) 4FA6	00	Inf. smart bombs
Dan Dare 2	(t) 7B91	A7	Inf. lives
Renegade 3	(t) 4DDF	C9	Inf. lives
Highway Encounter	(t) 0077	03	Freeze aliens
Ranarama	(t) 798C	00	Slows energy
Ramparts	(t) 6883	A7	Inf. energy (p1)
		68E1	Inf. energy (p2)
Sabre Mulf	(t) A570	A7	Inf. lives
Black Tiger	(d) 5612	A7	Inf. lives
T Bird	(t) 1433	A7	Inf. smart bombs
		15AB	Inf. lives
Fairlight	(t) 7D2F	00	Inf. life
Butcher Hill	(t) 115D)	A7	Inf. lives
		11FD)	A7
Spikey Harold	(t) 9C33	A7	Inf. lives
Laser Squad	(d) 4652	00	Inf. money

## THE MULTIFACE WAY

The (t)s and (d)s before the address indicate whether the poke was written for a tape or disk game (they might work on both, it's worth a try). Just in case you don't already how to put in these BLACK BOX POKES, here are the steps to success.

- a) Load the game as normal.
- b) Press the RED button on the Multiface.
- c) Press "T" for tool.

- d) Press "\*" to make sure you select the code.
- e) Press "H" for HEXADECIMAL input.
- f) Press "SPACE" for input.
- g) Type in the ADDRESS (4 characters ie. 3A7C)
- h) Type in the POKE (2 characters ie. A7)
- i) Press "RETURN"
- j) If there is more than one poke goto (f)
- k) Press "ESC" back to the menu.

## Snoopy

Way down in Gibraltar (The gateway to Atlantis), Xavier Cerisola has been working on the solution to **Snoopy**. I may come and visit you for as month or two, Xavier, I've been on the lookout for a friend with a deckchair in the sun...



First eat the FOOD then get the TYPEWRITER from the doghouse (kennel), and write a LETTER, give it to Charlie Brown. Get the COOKIE JAR and eat the cookies. Catch the FROG in the COOKIE JAR. Go to Lucy and scare her by letting the FROG loose. Pick up the RUBBER RING, which she drops, and put it beside the tree with a KITE in. Get the BALL and kick it into the water. Go and get the CATAPULT and then return to the water. Jump onto the BARREL then quickly onto the BUCKET (next screen). Jump on to the BALL and keep jumping until you reach land. Burst the BALLOON with the CATAPULT. Get the PUMP and go to the tree with the KITE in. Pump up the RUBBER RING and bounce on it. Get the KITE and give it to Charlie Brown, who drops a KEY. Pick up the KEY and open the SCHOOL LOCKERS. Pick up the BLANKET and give it to Linus. The game is complete.

## Ikari Warriors

David Hayes Of Neilston has been good enough to tell us that if you redefine the keys on **Ikari Warriors** so that both men are controlled by the same joystick, then choose a two-player game, move one man to the edge of the screen and then move the other until they are joined together, you can now play the game with double the firepower and double the ammo. That's what I call a really clever cheat, Dave.

## Eliminator

James Durrant from Gloucester has supplied the level codes for **Eliminator**:

- Level 2: BLOSP Level 3: ASDEL Level 4: XPLRT level 5: GLPWM Level 6: EOCKQ Level 7: LFPRT Level 8: WMCPR Level 9: Level 10: ZPEML Level 11: ELVPO Level 12 CPEMF Level 13: APXYQ Level 14 PWVAR







Every poke, map, hint  
and solution from the  
last twelve issues of  
Amstrad Action...

# CHEAT MODE INDEX

After the war Password AA60  
Agent x 2 Password AA53  
Airborne ranger Tape Poke AA58  
Airborne ranger Disk Poke AA59  
Altered beast Playing Tip AA57  
Arcade flight sim' (Qttro) Tp Pk AA64  
Army moves Password AA53  
Astro marine corps Keypress AA60  
Astro marine corps Password AA60  
Atv simulator Tape Poke AA62  
Batman 3d Disk Poke AA59  
Batman the movie Keypress AA53  
Batman the movie Map AA53  
Batman the movie Disk Poke AA57  
Batman caped crus Solution AA61  
Bedlam Keypress AA57  
Beyond the ice palace Tape Poke AA56  
Black tiger Disk Poke AA60  
Blade warrior Tape Poke AA61  
Bloodwych Playing Tip AA62  
Bloodwych Playing Tip AA64  
Bmx freestyle Keypress AA62  
Bombfusion Tape Poke AA58  
Bounty hunter Keypress AA59  
Bubble ghost Playing Tip AA63  
Buggy boy Tape Poke AA61  
Cabal Tape Poke AA53  
Castle master Disk Poke AA59  
Castle master Solution AA59  
Chase hq Keypress AA56  
Cholo Password AA53  
Classic arcadia Tape Poke AA56  
Continental circus Disk Poke AA57  
Continental circus Tape Poke AA64  
Count duckula Tape Poke AA60  
Cybernoid Keypress AA55  
Cybernoid 2 Keypress AA55  
Dan dare 3 Playing Tip AA64  
Death Stalker (Qttro) Tp Pk AA64  
Death stalker Map AA64  
Defenders of the earth Tape Poke AA63  
Dizzy 3 Solution AA54  
Dizzy 3 Map AA58  
Dizzy 3 Tape Poke AA63  
Double dragon Tape Poke AA61  
Dragon spirit Tape Poke AA57  
Dragons lair 2 Tape Poke AA60  
Druid Keypress AA55  
Dynasty wars Keypress AA63  
E-motion Keypress AA61  
E-motion Keypress AA63  
Elven warrior Tape Poke AA56  
Eqinox Keypress AA62  
Escape (Robot Mons) Tape Poke AA63  
Exolon Keypress AA55  
Frankenstein junior Tape Poke AA56  
Future bike simulator Tape Poke AA63  
Ghostbusters 2 Playing Tip AA54  
Ghostbusters 2 Solution AA55  
Ghosts and ghouls Playing Tip AA64  
Ghouls 'n ghosts Disk Poke AA58  
Grand prix simulator Keypress AA58  
Grand prix 2 Keypress AA61  
Grid iron Keypress AA60  
Guardian angel Tape Poke AA63  
Hard drivin' Tape Poke AA54  
Hard drivin' Disk Poke AA58  
Heroes of the lance Solution AA61  
Hopplin' mad Tape Poke AA58  
Hostages Disk Poke AA64  
Hotrod Disk Poke AA60  
Human killing mach Keypress AA60  
Ikari warriors Tape Poke AA58  
Ikari warriors Playing Tip AA64  
Impact Password AA64  
Impossamole Keypress AA60  
Indy jones/last crus Keypress AA52  
Indy jones/last crus Keypress AA55  
Into the eagles nest Keypress AA55  
Into the eagles nest Keypress AA57  
Italian supercar Tape Poke AA59  
Italy '90 Keypress AA61  
Jinks Keypress AA57  
Joe blade 3 Tape Poke AA55  
Joe blade 3 Playing Tip AA58  
Jungle warfare Keypress AA61  
Klax Disk Poke AA61  
Knightmare Playing Tip AA62  
Laser squad Playing Tip AA56  
Laser squad Tape Poke AA62  
Last ninja 2 Keypress AA60  
Last ninja 2 Solution AA62  
Little puff Keypress AA58  
Little puff Solution AA60  
Little puff Map AA62  
Live and let die Tape Poke AA64  
Lost caves Tape Poke AA54  
Lost caves Tape Poke AA55  
Mega buck\$ Password AA63  
Mig 29 soviet fighter Playing Tip AA63  
Moto cross simulator Tape Poke AA62  
Mr heli Disk Poke AA53  
Mutant fortress Tape Poke AA55  
Myth Playing Tip AA57  
Myth Disk Poke AA60  
Myth Solution AA63  
Newzealand story Tape Poke AA53  
Newzealand story Keypress AA55

Ninja mass (quattro) Password AA64  
Nuclear heist Keypress AA59  
Olli and lissa 3 Tape Poke AA57  
One man & his droid Password AA53  
Operation gunship Tape Poke AA52  
Op wolf (lightgun) Keypress AA56  
Op thunderbolt Playing Tip AA64  
P47 thunderbolt Keypress AA56  
Periscope up Tape Poke AA63  
Pipe mania Password AA59  
Pipe mania Disk Poke AA61  
Pirates Playing Tip AA59  
Pirates Playing Tip AA63  
Powerdrift Tape Poke AA61  
Pro boxing sim Tape Poke AA61  
Pro power boat sim Tape Poke AA62  
Pro power boat sim Keypress AA63  
Psycho hopper Tape Poke AA59  
Quattro power pack Tape Poke AA62  
Quattro combat pack Tape Poke AA64  
Rainbow islands Playing Tip AA61  
Rambo 3 Tape Poke AA60  
Rastan Playing Tip AA63  
Rastan Tape Poke AA64  
Real ghostbusters Keypress AA57  
Renegade 3 Keypress AA52  
Rex Tape Poke AA62  
Rick dangerous 2 Map AA62  
Ricochet Keypress AA63  
Rogue Tape Poke AA61  
Saigon combat unit Password AA55  
Saigon combat unit Tape Poke AA55  
Sas comb sim (Qttro) Tape Poke AA64  
Satan Password AA64  
Shinobi (AAdemo) Tape Poke AA52  
Snoopy Solution AA64  
Snowball in hell Tape Poke AA63  
Soldier of light Tape Poke AA59  
Space harrier Tape Poke AA56  
Space harrier 2 Disk Poke AA61  
Space rider jet pack Tape Poke AA63  
Spindizzy Keypress AA60  
Spooky castle Tape Poke AA64  
Starfox Password AA64  
Starion Password AA53  
Stormlord Keypress AA55  
Strider Keypress AA59  
Stunt bike simulator Keypress AA57  
Stunt car racer Disk Poke AA64  
Super stuntman Keypress AA55  
Supertank simulator Keypress AA56  
Supertank simulator Tape Poke AA56  
Tau-ceti (AAcover) Tape Poke AA64  
Tempest Keypress AA57  
Terramex Solution AA63  
Tetris Disk Poke AA64  
Three wks in paradise Keypress AA62  
Thrust Keypress AA59  
Thunderbirds Solution AA58  
Thunderbirds Tape Poke AA64  
Toobin' Disk Poke AA57  
Turbo boat sim Keypress AA57  
Turbo chopper sim Keypress AA58  
Turrican Tape Poke AA62  
Turrican Playing Tip AA63  
Twin turbo v8 Tape Poke AA62  
Twin world Playing Tip AA62  
Typhoon Tape Poke AA55  
Untouchables Keypress AA55  
Untouchables Playing Tip AA57  
Vampire Tape Poke AA54  
War machine Tape Poke AA52  
Who dares wins Tape Poke AA52  
Wizard willy Tape Poke AA54  
Wonderboy Tape Poke AA60  
Wonderboy Playing Tip AA60  
Xout Keypress AA59  
Yogis great escape Tape Poke AA60

## MULTIFACE POKES

After the war (t) lives AA58  
Airborne ranger (t) f.aid AA58  
Airborne ranger (d) f.aid AA59  
Apprentice (t) mult AA59  
Arc flight sim (Qttro) (t) lives AA64  
Army moves (d) lives AA59  
Artura (t) energ AA58  
Astro marine corps (t) grena AA62  
Atf (-) lives AA59  
Atv simulator (t) time AA62  
Ball crazy (t) lives AA61  
Barbarian 2 (t) lives AA58  
Batman (3d version) (d) mult AA59  
Batman the movie (-) grena AA55  
Batman the movie (-) grena AA56  
Batman the movie (d) mult AA57  
Battle of britain (t) fuel AA60  
Batty (t) lives AA55  
Batty (t) lives AA56  
Beyond the ice palace (t) mult AA56  
Bigfoot (t) lives AA59  
Bigfoot (t) lives AA61  
Bionic commando (-) lives AA59  
Black tiger (d) lives AA64

Blade warrior (t) mult AA58  
Blade warrior (t) mult AA61  
Bloodwych (d) mult AA63  
Bobby baring (t) helps AA58  
Bombfusion (t) mult AA58  
Bombjack (t) mult AA57  
Bombjack 2 (t) lives AA57  
Brian bloodaxe (t) lives AA58  
Bronx street cop (t) mult AA60  
Bubble bobble (d) lives AA58  
Bubble bobble (t) lives AA58  
Bubble ghost (t) bubbl AA64  
Buggy boy (t) time AA55  
Buggy boy (t) time AA56  
Buggy boy (t) time AA61  
Butcher hill (t) lives AA64  
Chase hq (d) mult AA55  
Chase hq (t) mult AA55  
Chase hq (d) mult AA56  
Chase hq (t) mult AA56  
Chicago 30s (t) lives AA60  
Cholo (t) invul AA61  
Cobra (t) shots AA57  
Combat school (t) timer AA55  
Combat school (t) timer AA56  
Continental circus (d) conti AA57  
Continental circus (t) cont AA64  
Count duckula (t) enemy AA60  
Crazy cars (t) time AA58  
Critical mass (t) craft AA60  
Daley thompson (t) lives AA58  
Dan dare (t) lives AA61  
Dan dare 3 (t) mult AA62  
Dan dare 2 (t) lives AA64  
Death Stalker (Qttro) (t) mult AA64  
Defenders of the earth (t) lives AA63  
Deflektor (t) mult AA57  
Desolator (-) lives AA59  
Dizzy 3 (t) lives AA63  
Doodlebug (t) lives AA58  
Double dragon (t) lives AA61  
Dragons lair (-) lives AA59  
Dragons lair (d) lives AA62  
Druid (t) energ AA61  
Dynamite dux (d) credi AA58  
Dynasty wars (d) energ AA62  
Elite (-) mult AA53  
Escape (Robot Mons) (t) mult AA63  
Fairlight (t) lives AA64  
Fast food (t) lives AA55  
Fast food (t) lives AA56  
Finders keepers (t) lives AA59  
Firetrap (t) lives AA57  
Flying shark (t) bombs AA64  
Forgotten worlds (-) mult AA53  
Frankenstein junior (t) mult AA63  
Future bike simulator (t) lives AA59  
Future knight (-) lives AA55  
Game over (t) lives AA56  
Game over (d) lives AA60  
Garfield (t) sleep AA61  
Get dexter (t) energ AA62  
Ghouls 'n ghosts (d) lives AA55  
Ghouls 'n ghosts (d) lives AA56  
Gilder rider (t) mult AA60  
Goonies (t) lives AA61  
Gryzor (d) lives AA64  
Guardian angel (t) lives AA63  
Gunsmoke (t) lives AA60  
Head over heels (t) mult AA60  
Highway encounter (t) freez AA64  
Hopplin' mad (t) lives AA58  
Hotrod (d) fuel AA60  
Hydrofool (t) rust AA64  
I ball (t) lives AA58  
Ikari warriors (t) mult AA57  
Indy jones/last crus (t) mult AA61  
Inside outing (t) mult AA58  
Italian supercar (t) mult AA59  
Joe blade 3 (t) baddi AA55  
Joe blade 3 (t) mult AA55  
Joe blade 3 (t) mult AA56  
Joe blade 3 (t) mult AA57  
Kane (t) helps AA58  
Karnov (t) lives AA59  
Klax (d) credi AA61  
Knight force (d) mult AA58  
Krakout (t) lives AA61  
Laser Squad (d) money AA64  
Licence to kill (t) lives AA59  
Licence to kill (d) mult AA60  
Live and let die (t) fuel AA62  
Live and let die (t) AA64  
Lost caves (t) level AA55  
Mask (t) damag AA61  
Mega apocalypse (t) lives AA58  
Mega apocalypse (t) lives AA59  
Metal army (t) lives AA61  
Mig 29 soviet fighter (t) mult AA57  
Mikie (t) invul AA57  
Molecule man (t) time AA64  
Motocross simulator (t) bikes AA62  
Myth (d) mult AA60  
Nemesis (d) mult AA62  
Ninja spirit (d) credi AA60  
Nodes of yesod (t) lives AA59  
Olli and lissa 3 (t) mult AA57

Operation thunderbolt (t) lives AA55  
Operation gunship (t) mult AA56  
Operation thunderbolt (t) lives AA56  
Operation hanoi (t) mult AA64  
Outrun (t) time AA60  
Palitron (t) energ AA58  
Parabola (t) lives AA62  
Periscope up (t) mult AA63  
Plasmatron (t) damag AA62  
Powerdrift (t) credi AA61  
Pro boxing sim (t) lives AA61  
Pro power boat sim (t) mult AA62  
Prohibition (t) lives AA62  
Prohibition (t) mult AA64  
Psycho hopper (t) mult AA59  
Psycho pigs uxb (-) lives AA59  
Quattro power pack (t) mult AA62  
R-type (-) credi AA55  
R-type (-) credi AA56  
R-type (-) mult AA59  
Race against time (t) time AA62  
Rainbow islands (d) resta AA57  
Rambo 3 (t) cont AA60  
Ramparts (t) energ AA64  
Ranarama (t) energ AA64  
Rasputin (t) heal AA58  
Rastan (t) lives AA61  
Rastan (t) lives AA64  
Red heat (t) mult AA59  
Renegade (d) pitfm AA64  
Renegade (t) pitfm AA64  
Renegade 3 (t) lives AA64  
Rex (t) lives AA62  
Rick dangerous (t) mult AA62  
Ricochet (t) lives AA58  
Roadblasters (t) mult AA58  
Rogue (t) energ AA61  
Rolling thunder (t) mult AA61  
Sabre wulf (t) lives AA64  
Sacred armour of ant (t) mult AA62  
Sacred armour of ant (t) mult AA64  
Saigon combat unit (t) mult AA55  
Sas combat sim (Qttro) (t) AA64  
Savage (t) lives AA61  
Scooby doo (t) ghost AA58  
Scooby doo (t) lives AA59  
Sdi (t) lives AA58  
Shadow skimmer (t) lives AA58  
Shinobi (-) lives AA55  
Shinobi (-) lives AA56  
Sidearms (-) lives AA59  
Silkworm (t) lives AA62  
Slap fight (t) lives AA60  
Snowball in hell (t) lives AA63  
Soldier of light (t) lives AA59  
Sonic boom (d) credi AA60  
Space harrier (t) fire AA56  
Space harrier 2 (d) lives AA61  
Space rider jetpack co. (t) lives AA63  
Speedzone (t) lives AA62  
Spikey harold (t) lives AA64  
Split personalities (t) mult AA58  
Spooky castle (t) lives AA64  
Stormlord (t) invul AA60  
Strider (t) energ AA61  
Stunt car racer (d) mult AA64  
Subteranean stryker (t) lives AA61  
T bird (t) mult AA64  
Tau ceti 2 (-) mult AA52  
Tau-ceti (AAcover) (t) mult AA64  
Techno cop (t) mult AA60  
The hit squad (t) lives AA56  
Thunderbirds (t) lives AA61  
Thundercats (t) lives AA60  
Tiger road (t) lives AA64  
Timescanner (d) balls AA59  
Tli (t) mult AA64  
Toobin' (d) credi AA57  
Turbo esprit (t) lives AA55  
Turbo esprit (t) lives AA56  
Turbo outrun (-) credi AA59  
Turrican (t) mult AA62  
Twin turbo v8 (-) mult AA58  
Twin turbo v8 (t) mult AA62  
Typhoon (t) lives AA55  
Ultima ratio (t) lives AA61  
Untouchables (t) times AA55  
Untouchables (t) times AA56  
Uridium + (t) mult AA64  
Victory road (t) lives AA60  
Vigilante (-) lives AA55  
Vigilante (-) lives AA56  
Vindicator (-) mult AA55  
Vindicator (-) mult AA56  
Vixen (-) lives AA59  
Warlock (t) lives AA58  
Wec le mans (t) time AA55  
Wec le mans (t) time AA56  
Wizard willy (t) lives AA56  
Wonderboy (t) lives AA60  
Wrigger (t) lives AA61  
Xcel (t) lives AA61  
Xevious (-) lives AA59  
Xybots (t) credi AA62  
Yabba dabba doo (t) lives AA59  
Yie ar kung fu (t) energ AA57  
Yogis great escape (t) mult AA60  
Zolyx (t) lives AA58



# HELPLINE

Feeling helpful? Just send your name, address, phone number (say if you don't want it printed) and subjects on which you're offering help to: **Helpline**, Amstrad Action, Beauford Court, 30 Monmouth Street, Bath, Avon BA1 2AP. Please write on a postcard or the back of a stuck down envelope and keep it short or you won't get in (or you'll get cut to 'load-sagames').

If you want help contact the appropriate Helpliner - not us. By post include a self-addressed, stamped envelope for the reply - or you won't get one. And phone only in decent hours!

Piracy is not welcome: don't try it, you'll get booted off. Keep it legal. And if you receive SAE's, for heaven's sake return them with some acknowledgement. Finally, if you want to come off **Helpline** just write in and say so.

I have *Operation Thunderbolt* and *Blasteroids* on disk. I want to swap for *The Animator* and *Laser Squad Expansion Kit* on disk. All mine are originals, so must yours be. Also help needed on translating code in *Catch 23*.

Simon Warford, 134 Draper House, Hampton St, London SE1 6SY

Selling games. Also wanted, pokes, tips and maps. Keypresses and cheats. Send SAE for list.

Mark Collins, 124 Shegoneill Ave, Belfast BT15 3JR Northern Ireland

Will anyone swap *Turrican* for *Shadow Warriors* and *Paper Boy*? Or *Batman the Movie* for *Operation Wolf*? Only in England please.

Paul Dugdale, 80 Charter Ave, Newbury Park, Ilford, Essex IG2 7AD

I have got *Italia 90* and *Man Utd* on tape (original). Anyone want to swap them for new games? Also I've got loads of mags to sell. AA 20-61, CWTA, ACU. Send SAE for list of cheap prices. I need to get rid of them.

Yong Pang, 12 Rheingold Way, Wallington, Surrey SM6 9NA

I own a CPC 464 computer. Help given on all games. Pen-pals wanted from anywhere aged 14-19. Male or Female. All letters answered!

Karen Orr, 128 Falside Cres, Falside, Bathgate, West Lothian, Scotland EH48 2DP

I have a CPC 464. I need help on *Ninja Warriors* and *Pacland*. Send SAE and I will give three pokes and P47 is one of them.

Peter Glikofridis, 8 Windsor Ave, Clacton on Sea, Essex, CO15 2AQ

Help wanted! I can't load the poke for *Cauldron I* from the 85 86 Book. Help also wanted on *Grange Hill*.

Christine McFarlane, 11 Nasmyth Rd, Barton, Eccles M30 7AP tel 061 789 2788

Has anyone got *Psycho Pigs UXB* (don't laugh) on disk to sell or to swap for *Desolator*, *Mega Apocalypse* or *Bards Tale* (all on disk)? Also, penpal wanted 11-14. male or female. Must have 6128 disk.

Stephen Daultrey, 8 Queens Ave, Woodford Green, Essex IG8 0JE

Wanted: PD software on tape for 464, GAC + home-grown software. All letters answered! Hi Jan-Fei. Iain McKinnon, 37 Loch Laidon St, Sandyhills, Glasgow G32 9HR

Wanted: *Battle Of Britain*, *Waterloo*, *Vulcan*, *Soccer 7*, *Ace Of Aces*, *Johnny Reb 2* (for tape). I will swap for games

like *Dizzy 1* and *3*, *RoboCop* and lots more. Please send list of the above games you have to swap and SAE to:

Declan Heerey, 1 Rivet House, Coopers Rd, London SE1 5HT

Help offered on all aspects of BASIC and assembly language programming. Don't forget the SAE!! Sean McManus 226 Chertsey Rise, Stevenage, Herts SG2 9JQ

Help needed. We have an SSA 1 Amstrad Speech Synthesizer and Amplifier with no instructions. When the tape is loaded a face comes on the screen and says something we can't understand. Then the word ready appears. We don't know what to do! Is there any chance of anyone helping is out? Mr G K Bradbury, 40 Ashmole Place, Blackbird Leys, Oxford OX4 5TN

Has anybody got *Italy 1990* (cassette only original) and AA45 for *Turbo Outrun* and *Gazza's Super Soccer* (both these games are cassette originals) Help needed on *Bloodwych*, and has anybody got key-press cheat on *Dizzy 1*? Telephone only for help.

Trevor Farnham, 92 Irwell Birch Green Skelmersdale WN8 6JZ Telephone 0695 32291

Calling all Helpliners. Does anybody want a pen pal to a person with a 464 and disk drive, who runs a PD library (Demon PD)? If they do, or if they want some PD or they've got any PD to contribute, write to the address below...

David Long, 47 Hilton Ave, Hall Green, Birmingham B28 0PE

Does anyone want to swap *Batman the Movie* for four of these games. *Sultan's Maze*, *Oh Mummy*, *Masterchess*, *Grand Prix*, *Grand Prix Sim*, *Helicopter*, *Grand Prix Driver*, *Bridge It*, *Chiller*, *Batman the Caped Crusader*. If interested write to:

J Rowe, 18 Lockington Crescent, Stowmarket, Suffolk, IP14 1DB

Female penpal wanted 12-14 to lend games and swap cheats, pokes. I own a CPC 464. Who'll write to a bored 13 year old? All letters get a reply!

Jimmy Brax, 28 Saffron Road, Bracknell, Berkshire, RG12 4BS.

If anyone has got *Stunt Car Racer* or *Fighter Bomber* on 464 tape to sell for no more than £5, I would be very grateful. I am also offering to swap any one of these, for these games: *Crackdown*, *E-Motion*, *Klax*, *Cholo*, *Ghostbusters II*, *Shinobi*, *Fernandez must Die*, and lots more.

Khalid Murad, 26 Wardown Crescent, Luton, Beds LU2 7JS

I have got a game called *Night Rider*, but I am having trouble on it. At the end I can't get the Bismark, I can get the U-boats, E-boats, planes and mines but I can't get the Bismark. Is there anyone who could show me how to bomb the Bismark please?

Amit Ruparetia, 54 Castlcombe Drive, Wimbledon, LONDON, SW19

Help desperately needed on *Rainbow Islands*, *Op Wolf*, *Forgotten Worlds*, *Ghosts 'n' Goblins* and *Black Tiger* to exchange for pokes and cheats for *RoboCop*, *Gryzor*, *Dizzy*, *Myth* and *Untouchables* (all on tape). Also AA's needed - 46, 51, 54, 55, 56.

David Woodward, 85 Drayton Rd, Sutton Courtenay, Abingdon, Oxon OX14 4HB

I need some instructions for non-movement actions for *Renegade*, e.g. flying kicks, punches, floor punches etc. Also wanted: maps for *Short Circuit* and *Price of Magik*, pokes for *Super Robin Hood* and *Dizzy*.

Ben Sizer, 6 Greave House Terrace, Lepton, Huddersfield, West Yorkshire HD8 0DQ

Could anyone give me a cheat (not a Multiface) for *Ghostbusters 2* (level 2) and for *Batman the Movie* (level 1)? Also, pen pal wanted age 10 to 12. Has to have a CPC 6128 and disk drive.

David Searle, 20 Shalloch Park, Doonfoot, Ayr, Scotland KA7 4HL

Help wanted on *Type-In AA28*, *Streamer*. I keep getting Syntax Error in Line 820. Can you help?

Mr J M Pearson, 7 Muschamp Tr, Warsop, Notts NG20 0NL telephone 0623 846017

Help urgently needed with *AMX Stop Press*. Extra fonts and clip art pages required. Will provide disks and postage.

Simon Pearce, Chapel Rise, High St, Swineshead, Boston, Lincs PE20 3LH

I can offer help with BASIC. All SAEs answered.

Nick Allen, 7 Hawkswood Ave, Frimley, Camberley, Surrey GU16 5LH

Desperately Wanted; *New Zealand Story* on tape. Will swap for *Wild Streets* and *Airwolf* or *Indiana Jones* and *the Last Crusade* and *Airwolf*. All on tape. Also have a lot of cheats. If you want some please send an SAE.

Jonathan Portlock, 5 Westville, Hebden Bridge Rd, Oxenhope, Keighley, West Yorkshire BD22 9JS. Tel 0535 44995

## OH!

Helpline is for readers wanting help, tips or penpals, or offering any of the above. No money is to change hands, OK? This page is for free help only. If you send in an entry asking for money for your services you're wasting your time and a stamp - it'll be straight in the bin. On the other hand, send in a cheque for £5 and you could go in Small Ads...

Has anybody got *Hacker* and *Hacker 2* to swap for *RoboCop* or *Batman the Movie*? Also, has anybody got a poke anywhere for *Bactron* or *Munsters*?

S Hurst, 8 Restormel Rd, Barbican, East Looe, Looe, Cornwall PL13 1EJ Telephone 05036 4472

Help wanted on *Elite* - tape POKE would be nice. I can HELP with *Lords of Chaos* and *Bloodwych*.

Penpal wanted any age to SWAP GAMES and pokes tips.

Chris Palmer, 257 The Hides, Harlow, Essex, CM2Q 3QU.

Desperately wanted, Issues 49,50 and 51 of AA will swap for *Thunderbirds* or February to October issues of *ACU*. Also swap *Heroes of The Lance* for *Bloodwych*, *Tolkien Trilogy* or *Bards Tale* (on TAPE PLEASE). I've also got *Adeptus Titanicus*, *Blood Bowl*, *D+D*, *Star Trek* + more to swap for Multiface 2. (Remember to State Your Address).

Contact:

J. Boniface, 119 Grinstead Lane, Lancing, Sussex, BN15 9DR

Hi there! I have *Cyberball* and would like to swap for *Double Dragon 1* or *2*. 464 tape only. Are you interested?

Daniel Ware, 33 Salisbury Rd, Grays, Essex RM17 5DG

HELP! Need some kind soul to sell me *Boulderdash Construction Kit* on disk. Just write to me, sending details, or give me a nice happy phone call on (0302) 323266.

PS Please can I have a witty comment from Rod in brackets ????? (daft, ranting clot - ed)

Mark Berbezier, 47 Lakeen Road, Intake, Doncaster, South Yorkshire, DNZ 5HB.

Help! Has anyone got *Rick Dangerous 1* or *2* to swap for *Ghostbusters 2* and *Laser Squad* (tape please). Also does anyone have the keypress cheat for *New Zealand Story*? (From AA55)

Tobi Forsdyke, 14 Dagmar Rd, Stroud Green, London N4 4PB

Penpal wanted, 16 years old, 6128 owner to exchange hints, tips, maps, pokes and Public Domain Software help on lots of games. Need help with machine code.

Brett Ironmonger, 1/32 Kenneth Hopper Place, Whangaparaoa, New Zealand.



# DAY OF DARKNESS

the fantastic new role-play adventure game

Why is there a deep axe cut in the wall at Graybrook House?

whose voice can be heard at the end of a dead telephone line?



As Keith Kirtson, private detective you must find out before the dawn of the DAY OF DARKNESS

0898 5555 22



ENTER THE WORLD OF



Dr Who and Ace confront their old enemies, the Daleks - you can determine the outcome of the conflict, when you dial

0839 12 11 15

PLUS THE DR WHO QUIZ  
0839 12 11 25



## The Fortress Of Doom



Castles and caverns, monsters, myths, and master magicians. Become LONE WOLF, the last Kai Master of Sommerlund, and determine your destiny in this FANTASTIC AUDIO-ADVENTURE.



Level Two Now Open!

0898 555 525

Calls cost 33p (cheap) 44p (other times) per minute inc VAT. Broadsystem Ltd., London NW1 8NP.

# Happy Birthday Maxam

It is the 5th anniversary of the release of Maxam, the first ROM based program for the CPC. To celebrate this occasion Arnor are having a sale of CPC products for the first time.

Everyone knows that our ROM software is the best business and utility software for the CPC, so we will just give you the prices :-

All 7 Arnor ROMs are available at special prices and additional savings may be made by buying more than one program. The programs are:

Protext	Maxam
Prospell	Maxam 1.5
Promerge Plus	BCPL
Utopia	

The ROMBO ROM box can also be supplied at an additional cost of just £20 if one or more program is being purchased. We are unable to supply the ROMBO separately.

Please note that if Maxam 1.5 and Protext are purchased then Maxam is not needed.

Number of ROMs	price without Rombo	price with Rombo
1	£25	£45
2	£40	£60
3	£60	£80
4	£75	£95
5	£90	£110
6	£100	£120

ORDER FORM - Send to: Arnor (AA), 611 Lincoln Road, Peterborough, PE1 3HA

- Please send me (indicate where applicable):
- |                                    |                                     |
|------------------------------------|-------------------------------------|
| <input type="checkbox"/> ROMBO     | <input type="checkbox"/> PROTEXT    |
| <input type="checkbox"/> PROSPELL  | <input type="checkbox"/> PROMERGE + |
| <input type="checkbox"/> UTOPIA    | <input type="checkbox"/> MAXAM      |
| <input type="checkbox"/> MAXAM 1.5 | <input type="checkbox"/> BCPL       |

I enclose Cheque / Postal order for £  or debit my

Access/Visa card no.  Exp.  /

Name .....

Address .....

Postcode.....

Releasing your micro's potential...



Arnor (AA), 611 Lincoln Road, Peterborough, PE1 3HA. Tel: 0733 68909 (24hr) Fax: 0733 67299  
All prices include VAT, postage and packing. Credit card orders will be despatched by return of post. If paying by cheque please allow 10-14 days for delivery.



# MICROGENIC SYSTEMS

At Last The Home Computer Enthusiast Can Have Professional High Quality Accessories For All CPC Computers

Our programmer is not fussy about which brand of EPROMs you buy, it programs them all! Easy to use menu driven software which is supplied on ROM, the ZIF socket and many other special features and you have a professional unit. **FOR ONLY £69.95**

Our successful 8 socket ROM board also has a host of features and uses on board switches to provide the following benefits:  
 • Easy bank switching 0-7 to 8-15 • Fast ROM selection • Convenient board enable/disable • Useful computer hardware reset

This no-compromise ROM board **ONLY COSTS £34.95**

Both products use the latest technology high quality components and can be left safely and permanently connected to your CPC, using their built in flow-through connector. Additional items to complement your computer system:

EPROM ERASER £22.50 WITH TIMER £27.50  
 EPROMS 27C64 £5.95 27C128 £6.95  
 EPROM ANTI STATIC BOX £2.50

P&P UK FREE, EUROPE £1, ANYWHERE ELSE £2. CHEQUES AND POSTAL ORDERS MADE PAYABLE TO:

**MICROGENIC SYSTEMS** Unit 15, The Brampton Centre, Wath-upon-Deerne, Rotherham S63 6BB. Tel: 0709 876743



MEL CROUCHER  
 -COMPUTER  
 FUN LINE

0898 299399  
 3 mins of mind blowing entertainment



THE HOTTEST GAMES SECRETS  
 0898 299366  
 MEGATIP GAMESLINE

NEW MESSAGES EVERY WEEK

TONY TAKOUSHI  
 CONSOLE LINE

0898 299390

games tips news-gossip

Proprietor B. Everiss, P.O. Box 71, Kington, Warwick, CV35 0XA.

Calls charged at 33p per min. cheap rate and 44p per min at all other times.

(Ask whoever pays phone bill)

# TECHNISOFT

113 Potter Street, Northwood, Middlesex, MA6 1QF

## MASSIVE CHRISTMAS SAVINGS !!!

All Amstrad Computers at **£150 off !!**

Amstrad GSx4000 console **£69.**

All software/hardware at discount prices.

Phone 09274 22884 after 7pm for further details or call up the TECHNISOFT mailbox on Prestel.

Access and visa cards welcome.

- TECHNISOFT - one of the up and coming companies of 'KELLY ELECTRONICS'.

## NEW! THE HOME STUDY DISC NEW!

**HOME STUDY:** The essential tool for students. Makes revision simpler. Includes a typing tutor mode complete with test data.

**HOME FILE:** Keeps all your records in order. Special information field. 12 instantly accessible files, search, sort etc.

**HOME FINANCE:** 12 accounts supported. 200 entries a month on each account. Automatic standing orders, salaries etc.

All these programs supplied for the 6128 complete with manuals on disc for only £11.95. Cheques or P.O.s made payable to,

M.J.O. SOFTWARE (AA)

45 Station Avenue, Tile Hill Village, Coventry CV4 9HR

# THE ROMANTIC ROBOT SOLUTION!



LIFE WITHOUT DIRECTION

REBEL WITHOUT A CAUSE



CHRISTMAS WITHOUT PRESENTS



**A CPC without a MULTIFACE TWO? What a glorious waste of time.**

If you use a CPC without a Multiface, you're wasting time.

Loading programs always from the start instead of continuing from where you stopped last time, not being able to make crucial back-ups whenever you need to, not having a chance to customize programs or just poke infinite lives - what a waste!

**MULTIFACE is to CPC what wheels are to cars - the ESSENTIAL ADD-ON!**

Its **MAGIC** button lets you **FREEZE** a program ANY time - just have a break and continue later, or **SAVE**, switch off, and reload to continue later. Saving is **FULLY automatic**, all is menu-driven with on-screen instructions, error reports - **SO EASY!** You can also study/modify programs with the built-in **MULTI-TOOLKIT** - invaluable!

If you wish to make your computing easy, fast, safe and a joy - **get a MULTIFACE!**

A CPC WITHOUT A MULTIFACE



You MUST NOT use any of these products to copy, reproduce or infringe in any way any copyright material without the clear permission of the copyright owner. We do neither condone nor authorise the use of our products for the reproduction of copyright material - to do so is ILLEGAL!

## The puzzle's over! MULTIFACE - the CPC's missing link!

Also available: Please send a SAE for details

**INSIDER** - By residing OUTSIDE CPC - in a MULTIFACE - it can look INSIDE and disassemble ANY running program  
**RODOS** - A ROM that changes CPC into a professional system

Hurry to get **BIG DISCOUNTS**

MULTIFACE 2 for CPC 464/6128  £47.95 **£37.95** or for CPC+  £49.95 **£44.95**  
 RODOS  £29.95 **£19.95** RODOS XTRA  £9.95 **£6.95** INSIDER  £14.95 **£9.95**

PLUS P&P per EACH item: UK £1, Europe £2, Overseas £3.

enclose a cheque/PO/cash for £..... or debit my Access/Visa No.

Name/address.....

The above reduced prices apply strictly only to MAIL ORDERS received by 15.1.1991.





# AFTERTHOUGHT

If this page was a horse you'd shoot it. Spectravideo waggler winners ahoy!

We've had some wonderfully witty answers to last month's Chrimbo pressie list compo, but unfortunately we couldn't print all of them... c'mon, we did ask you to keep them clean. Here, however, are those that we could print...

**Garry Smith of Carlisle** wants:

- A Commodore Amiga (*oh, sure, very funny...*)
- That woman out of *Baywatch* complete with double-size bed
- 12 condoms and a jar of...
- OK, that's enough. See what we mean?*

**Stephen Malpas of Bristol** wants:

- Ultra-fabby Spectravideo joystick
- Ton of lard (*eh?*)
- BBC1's spinning globe
- Framed picture of Denis Thatcher
- A caterpillar's brain (*got one, haven't you?*)
- Some custard to go with it
- Teenage Mutant Ninja Parsnip
- Toilet flush (on CD please)
- Bob Holness

Small slide of Rod's home-made wine  
*Well done, Stephen, but we think you forgot the straightjacket*

**Steve Schleising of Oxon** wants:

- Blow-up Rubber Doll Sim (Virgin)
- Easter egg
- TNT (Domark) (To blow up the rubber doll)
- 5 pairs of knee-high grey socks

"Dear Santa", says **Simon Bayles of Mansfield**,  
"You had better get me all the things I am going to ask for, or I'll come round your grotto and kick your bleedin' teeth in."  
*OK, you win you ghastly little oik*

**Dave Stokes of Roslin** wants:

- A real, full-size Teenage Mutant Ninja Turtle to scare the living daylights out of my son so that I will no longer have to share my home with a complete set of Turtle merchandising (*ooer, a bit a politics there...*)
- Two silicon disks; I think I can swing this one

as the wife thinks she can use them to improve her figure (*it's about all you will swing if she spots this, pal*)

A porcupine quill, otherwise this competition will be completely pointless (*er, like that joke?*)

A laptop computer (organic)

Dave wanted a cowboy outfit, but we can't print *which* outfit because despite what he says, it *is* libellous. We'll leave you guessing over that one...

Congratulations, you lot! Your ultra-waggy fabbler, er, ultra-faggy wabblers... um, that is joysticks are on their way.

## CAPTION COMPO WINNER

Well, we had one or two, er, *unusual* entries for this one, but the winner has got to be the one we received from **James Edwards of Blackburn**:

● "The wife! Quick, hide in here..."

To the newsagent: *Amstrad Action* is distributed by Future Publishing

Dear newsagent,  
Please reserve me a copy of the February issue of *Amstrad Action*, due out on the third Thursday in January

Name:

Address:

If you're under 16, please get your parent or guardian to sign here:

## ADVERTISERS INDEX

Anco.....6	GMF Programmes .....95	Rickett .....9
Arnor .....91	Gremlin .....15	Romantic Robot .....9
Boxoft.....83	Home Based Business .....95	Seersoft .....3
Bruce Everiss.....92	Instamec .....83, 95	Selec Software.....7
Broad Systems .....91	Intraset.....95	Serious Games .....6
Brunning Software .....38	K & M Computers .....79	Software Superstore .....8
Caspell.....67	Microgenic Systems.....92	Technisoft.....44, 4
Challenge Software .....61	Microprose .....64, 65	UBI Soft .....1
Compumart .....60	Microstyle.....30	US Gold .....7
Datel Electronics.....34, 35	MJC Supplies.....54	Wave .....7
Dial-A-Quiz .....46	MJO .....92	Worldwide .....6
Dunning .....78	Ocean.....IFC, 3, 53, 98, IBC, OBC	Wacci UK .....1
First Choice Software .....79	Osprey .....30	Zeppelin Games .....4
Glenco Software .....83	Proton Software .....61	





# AA SMALL ADS

## For Sale

**BUSINESS SOFTWARE** for the CPC6128 and 6128+ small business accounts £27.60. Costmaster £28.75. Sample disk - contains all our software, without printing/disk routines £4.60. ABC Software, 31 Magdalen Way, Worle, W.S.M. BS22 0PG. (0934) 516714 anytime.

**64K DTP!** At last on 464/664. Page Setter 64. Full range of options. Disk now, tape soon. Just £10. Cheque/PO to: Bit-7 Computer Software, 221 Rockingham Road, Kettering, Northants, NN16 9JB.

**AMSTRAD GAMES FOR SALE.** Tape and disk based. Most in good condition. Sell for a reasonable price. Telephone Thomas Dudding on (0202) 693748. Will split. Please phone after 7pm.

**CPC464 COLOUR MONITOR,** £300 worth of games including - Operation Wolf, Batman (Movie), Driller, Darkside. Loads of mags. All worth £600. Will sell whole lot for only £295. James (0444) 235322.

**AMSTRAD 464,** colour monitor, over 30 magazines, dust covers, 2 joysticks, over 70 games, including Ghostbusters II, Chase HQ, Klax, Robocop, Gryzor. Worth £850, sell for £300. Telephone (0639) 891330.

**CPC664** colour monitor and tape recorder. Games on disk and tape c/w joystick & manual, exc. condition £200 o.n.o. Phone 081-950 7523.

**CPC464** colour monitor dust covers magazines and over £800 worth of games including Cyberball, Chase HQ, Klax, Italy 90, Myth, worth over £1,000, selling for £300 o.n.o. Phone (08697) 8185. Buyer must collect.

**6128 DISK SOFTWARE:** EMR Miditrack Performer £25, Foundation Steptime £20, French Mistress £8, Mini Office 2 £8, OCP Advanced Art £15, Tolkien Trilogy £5. Ring John on (0543) 491369 after 8pm.

**AMSTRAD CPC464** colour monitor, disk drive, disks, cassettes, original software, cost £250. Drum machine, joystick, manuals, books, £300. G. M. Habgood, (Little Chalfont, Bucks). Tel: (0494) 762785.

**DDI,** Romboard, Multiface, Pen, Speech, mags, mouse, disks, RODOS, Diskology, CPM3, memory, covers, FDI, Bonzo, tapes, Cheat 1, books, 6128 chip, compilations. Phone for list, ask for Jim: 051-639 5314.

**CPC464 MONO MONITOR,** Genius mouse + interface, OCP Art Studio, 64K memory expansion, over £300 worth of games, including Rainbow Islands and Bloodwych, manual £300 wanted. Tel: Andrew (0282) 52163 buyer collects.

**CPC464,** colour monitor, lightpen, lightgun, dustcovers, joystick, loads of AA's, over £400 worth of software - all great games. Sell for £300 o.n.o. Tel: Mark (0509) 413643 (evenings only) for details.

**CPC6128 COLOUR MONITOR,** manual, joystick, disks, include Fighter Bomber, Carrier Command, Mini Office, lankey Typing, plus other games, dust covers, blank disks, hardly used, £250. Phone 081-807 1921 after 6pm.

**CPC464 COLOUR MONITOR,** Multiface II, Speech Synthesiser, joystick, £200 worth of software and lightpen, in good condition. Phone Kym after 9.30pm on (029577) 806. Only £400 including dust covers.

**CPC6128 COLOUR DISK.** Inbuilt tape facility. Tasword, Taspell, Masterfile 3, Mastercalc, Minor utilities, some games, joystick, manual, AA/ACU's from 1985 (March) £200 the lot. Ring (0747) 54303.

**CPC464** keyboard, monitor, joystick and games and manual £180. Phone (0276) 32958 after 6pm.

**CPC464 GREEN MONITOR,** joystick, 106 games worth £723, (including Ghostbusters 2, Crazy Cars 2, Moonwalker.) MP1 colour modulator, stereo booster, speech synthesiser, loads of AA magazines, worth £1000, sell for £270. Phone (0268) 410056.

**CPC6128** with colour monitor, new disk drive fitted, manual, dust covers, joystick and Tandy DMP106 printer. Disk software including Mini Office II, many adventure, wargames, arcade. Also a few games on tape. All worth over £1400, yours for only £700. Call Nigel (0709) 790432 after 7pm.

**DDI-1** disk drive, £60 o.n.o. Old AA and ACU back issues, £7 each. Phone for availability (0305) 848 879. Then send SAE's to Sycamore Cottage, Tolpuddle, Dorchester, Dorset, DT2 7ES.

**CPC6128** colour disk tape 50+ games Multiface 2+, Speech Synthesiser, manuals, Amstrad books, DMP2000 AA's 11-63, Protect ROM, Mini Office 2, Assembler/monitor, new, value £1320 sell £600 o.n.o. Tel: Julian 081-940 7456.

**CPC6128 COLOUR MONITOR,** DMP2000 printer, Multiface 2, mouse, tape deck with leads, Protect, Stop Press, Compiler, 50 games, 39 AA's, 39 other magazines, worth £1000+, sell £500 o.n.o. Tel: 061-941 2862.

**CPC6128,** green screen, AMX mouse, Pace serial port, loads of serious software inc. Micro Design, Mini Office 2, Tasword, Turbo Basic, etc. Good condition, asking £200. Phone (0604) 39008 (Andrew).

**AMSTRAD CPC6128,** mono monitor, OCP art + mouse, Qualitas+, loads games (tape + disk), blank disks, type-ins, 8-bit printer port, manuals, v. good condition, £300. With Star LC-10, £420, AA's 28-62, offers welcome. Ring (0727) 51037.

**£500+ PER WEEK** potential! A call to the Home Business Enterprise Line (0898) 771 865 now will get you started fast. 24 hour service. Calls cost 33p/min cheap rate, else 44p/min.

**GAMES FOR SALE,** originals, excellent condition, includes Gauntlet, Dark Side, Time and Magik, Platoon; plus GAC, Image System and many more: worth £250+ all for £80. Phone (0224) 734931 after 4pm. (Tape).

**CPC6128 COLOUR MONITOR,** TV Modulator, clock radio, Multiface II, cassette recorder + leads, dust covers, AMX Art and mouse, over £350 software, excellent condition, with mags. Offers over £350. Phone (0304) 204530.

**CPC6128 COLOUR,** Epson RX80 2ND DD Taswor, Qualitas 8 bit printer port Prospell, Advanced Art, Stop Press, mouse, Multiface 40 disks, AA1-63 (worth a fortune). Offers? Phone (0443) 772211 evenings.

**AMSTRAD CPC6128 COLOUR MONITOR,** £150+ games, Op. Wolf etc., 45 mags, Multiface II, joystick, blank disks, 1000+ pokes, manuals, etc. Excellent condition, would cost £675+, sell for £300. Tel: (0892) 544282 anytime (preferably evenings).

**THE CYNOTEL BBS SYSTEM.** Thousands of pounds of CPC hardware and software for sale. RS232s modems, printers, drives, TV tuners, ROMS all at prices for the user. Julian: 081-346 2524 (2 lines).

## Wanted

**CAGE ROM ANYWHERE?** Willing to pay up to £35. Write to: 53 Miles Avenue, Sandford, Wareham, Dorset, BH20 7AS or tel: Lena Ward, (0929) 552512 (after 5.30pm).

**COLOUR MONITOR** for Amstrad CPC6128. Tel: (0254) 581389.

## Services

**BARDS TALE** maps/hints for all levels. Send £3.00 and large (A5) S.A.E. Supercharged and equipped tape/disk parties, send £1.50 S.A.E. saved parties, P.O./Cheques to: M.A. Bond, 22 Walnut Tree Way, Tiptree, Essex, CO5 0NH.

## USER GROUPS

**AMSTRADS DEN COMPUTER CLUB,** £10 life membership, monthly newsletter, packed full with ideas, news, listings and pokes. For more information send SAE to L. Scarfe, Lyngwhite Farm, Little Ellingham, Attleborough, Norfolk, NR17 1JG.

## OTHER

**PRINT-OUT (ISSUE 6),** - 42 pages of articles for all CPC owners. Includes both machine code and Basic tutorials and programs. Also tips, CPM, reviews, Public Domain, special offers and much more. It costs £1.10 (including p&p) from: Print-out, 8 Maze Green Road, Bishops Stortford, Hertfordshire, CM23 2PJ.

**PRINT-OUT (ISSUE 7),** contains 42 pages of articles for the CPC, covering all aspects fo serious computing. Includes machine code and Basic programs and tutorials, tips, news and much more. Plus prizes to be won. Costs £1.10 including p&p from: Print-out, 8 Maze Green Road, Bishops Stortford, Hertfordshire, CM23 2PJ.

**MAKE LOADSAMONEY** the quick and easy way. 2-3 hours a week needed publishing business reports. No experience needed. S.A.E. to: Declan Harris, 31a St. Georges Road, Leyton, London, E10 5RH.



This section offers you a really cheap and effective opportunity to speak direct to 35,000 CPC owners - or would-be owners. Users report excellent results. You can place an ad up to 30 words for just £5.

So you could use it to sell a printer, launch a user group or advertise a piece of software you've written. One thing you can't advertise is the sale or swap of software. Such ads can be misused by pirates.

Fill in the application form and send it to us together with payment. We'll place the ad in the next available issue (published 2-7 weeks after we receive your order).

## ORDER FORM

SEND TO AA SMALL ADS, FUTURE PUBLISHING LTD, BEAUFORD COURT, 30 MONMOUTH STREET, BATH, AVON BA1 2AP

Please place the following advertisement in the next available issue of *Amstrad Action*

Name \_\_\_\_\_

Address \_\_\_\_\_

Telephone \_\_\_\_\_

I enclose payment of £5.00 by Cheque/ P.O./ Access/ Visa

Credit Card number \_\_\_\_\_

Credit Card expiry date \_\_\_\_\_

Classification. Tick box:  For sale  Wanted  Services  User Groups  Other

Write your advertisement here, one word per box. Include your name and phone number if you want them



# FRENCH TEST



Flexible vocabulary testing programme with all words needed for GCSE divided into easy to learn topics

£15.95 - disc only

"French Test is an excellent utility which puts the fun back into learning" A.C.V

NOTE: Using this program ensures success at GCSE - pass or we guarantee to refund your money in full.

Plus

LA GUILLOTINE - Hangman with a difference!

Keep your head when guessing the translation. Further details available

Cheques/P.O.s to: GMF Programs, Dept AA.

21 Northwick Park Road, Harrow, Middx.

HA1 2NY Tel: (081) 861 2891 Plus evenings



A wide range of  
**EDUCATIONAL SOFTWARE**  
for AMSTRAD CPC, PCW, PC and all popular home computers is detailed in our full colour  
**PARENTS' GUIDE**

Ask for a free copy together with a specific listing for your make of micro.

**RICKITT EDUCATIONAL MEDIA**  
Freepost TU823, Ilton, Ilminster, Somerset,  
TA19 9BR. Telephone (0460) 57152  
Fax (0460) 53176

# WANTED



DEAD  
OR  
ALIVE

USE YOUR VOICE  
TO OUTDRAW THE  
GUNFIGHTER

CASH PRIZES

**0898 31 35 78**

INFODIAL POBox 36 LS1 4TN Call charges 33p Per Min Cheap 44p Per Min All Other Times

## MAKE YOUR PC EARN

Yes making money with your PC becomes incidental when you know how. Your micro is, if only you knew it, a gold mine. The size and make is irrelevant. Make initial effort NOW by starting your own

### HOME BASED BUSINESS

*This may be the most important move you will ever make!*

REMEMBER: You'll never get rich by digging someone else's "ditch". Anyone in country, including YOU, can become very rich in a relatively short period of time by doing a few basic things! It's more rewarding than playing games. The benefits are many and varied. Full or part time. For FREE details send S.A.E. to:



## HOME BASED BUSINESS

31, PILTON PLACE (AA14)  
KING AND QUEEN STREET,  
WALWORTH, LONDON SE17 1DR

## COURSEMASTER

The Computer Horseracing Program

- RATES ANY RACE IN SECONDS - ANY DAILY NEWSPAPER IS ALL YOU NEED
- NEVER out of date - Both N. Hunt & Flat - Fast Data Entry
- AMAZING ACCURACY!! - Now you CAN BEAT THE BOOKIE!!
- Works on the simple principle that FAST HORSES BEAT SLOW ONES!!
- Clearly identifies best selection in every race plus these AMAZING features:-
- First, Second and Third choice shown for Forecasts & Tricasts, etc.
- Recommends most suitable type of bet.
- Actually works out your WINNINGS on most popular bets including SINGLES & DOUBLES, win and each way. PATENTS, YANKEES, CANADIANS, HEINZ etc. GOOD EACH WAY and LONG ODDS bets clearly shown.
- Will PRINT out your BETTING SLIP for you.
- Maintains a BANK ACCOUNT - BET like PROFESSIONALS do! Records all your bets in any number of accounts. Keep a complete record of your betting or compare COURSEMASTER against your favourite tipster.
- PLUS!!!! - The AMAZING COURSEMASTER SYSTEM. This superb betting system is included in the program. A system which regularly produces huge wins from small stakes. Try it! It can pay for itself many times over on the first day!
- Supplied with 90 Page BETTING GUIDE and MANUAL.

## PERM-MASTER

If you are one of those pools punters who regularly uses the perm plans for entering your weekly coupon, (as we at Intraset recommend). Then it is often difficult to assess whether or not you have actually won. PERM-MASTER puts an end to that. With it you simply enter the number of points obtained for each of your selections, and PERM-MASTER does the rest. The program is supplied already with some of the top plans built in, but if your favourite is not there, then you can simply create your own, using the unique perm editor.

- FAST and SIMPLE to use.
- UNIQUE PERM EDITOR allows you to add plans not supplied (Simply edit the X's)
- For most BLOCK PERMS and SINGLE LINE plans. (Up to 25 selections)

Available as for POOLSMASTER @ £17.95 inc P&P + VAT

## £ PROFIT FROM YOUR MICRO

- WHATEVER your MICRO is you can use it to make a good income!
- Even if you only have a couple of hours to spare each week.
- We have put together a package of easy, sensible and practical business ideas which can easily be used by anyone with any micro.
- No computer expertise required!!
- Earn £££'s from home doing what you enjoy doing - using your COMPUTER!! It doesn't matter which model.
- You probably already have all you need to start earning.
- THOUSANDS of potential customers in your area who will GLADLY pay for your services. We will show you how to find them!
- Full step by step guide to EARNING MONEY FROM YOUR MICRO. FREE BUSINESS IDEAS CASSETTE TAPE WITH EVERY COPY

£12.95 inclusive

All progs available for all PCW's, all IBM PC's + compatibles, Amstrad PC's, Atari + Amiga + CPC 6128. Coursemaster + Poolsmaster also available for Spectrums, Commodore 64+128, CPC 454+664.

## POOLSMASTER

(Formerly 'Pools Predictor' by Corven Computer Systems)  
The Computer Football Pools Predictor

The amazing POOLSMASTER program is by far the best Pools Predictor we have ever seen. In just 10 weeks of trying this program ourselves, we won no less than 12 dividends, the largest being nearly £300. Mr F. C. Hammond from Essex won nearly £10,000.00 in just 16 weeks. In his own words "It's a licence to print money". POOLSMASTER is simple to use and requires only that you keep the league tables up to date using your usual newspaper.

The result of many years research into the Football Pools by the programmer Martin Evans of C.C.S., the program is a masterpiece of expertise, and is simplicity itself to use.

- Predicts Homes, Aways and Draws
- No fiddly typing in of teams names etc and no redundant databases.
- Instant read-out or Hardcopy if you have a printer.
- Uses scientific formula based on recent form home and away, league position, goals scored etc. It has long been realised that certain combinations of these factors return a much higher than average of draws than the laws of average would expect. POOLSMASTER looks for these factors and analyses their significance to give you the best possible chance of a win.
- Also has a "Sequence Predictor" option. Many people believe that certain numbers on the coupon come up more often than others, and over a season patterns do seem to develop. The program analyses these patterns and predicts the numbers most likely to come up next. Certainly more scientific than sticking a pin in, or family birthdays etc.

If you do the POOLS then this is the program for you.  
@ £17.95 tapes, £19.95 discs, inc P&P + VAT

## +++SPECIAL OFFER+++

**SPECIAL COMPENDIUM DISKS:** Please state British or Australian version  
CONTAINING BOTH POOLSMASTER AND PERM-MASTER - £36.95  
CONTAINING POOLS, PERM AND COURSEMASTER - £49.95  
**BUY ANY THREE DISKS (OR TWO INCL COMPENDIUM)  
AND RECEIVE PROFIT FROM YOUR MICRO ABSOLUTELY FREE**

## THE GRAPHOLOGIST

This program is a must for anyone interested in analysing their handwriting, or analysing other peoples. It is also very useful for analysing prospective employees handwriting. To use the program, a sample of handwriting is obtained, preferably in ink. From the main menu of the program you will be prompted and guided to examine each detail of the sample. You will then be taken through deeper and deeper sets of sub menus, all prompting you for relevant details of the writing, and the points to watch for, and add to the file if applicable.

Upon completion you are left with a disk file up to 15 pages long (depending on the depth of detail you choose), this file can then be edited within your word processor to produce a full report for the writer. Fully experienced Graphologists can charge almost what they like for a full analysis, so this could prove a very lucrative business venture for you. We must however stress, that unless you are experienced in graphology, then we can in no way guarantee the accuracy of the information that the program provides. If you are an enthusiastic amateur or just curious, then this program could provide hours of entertainment, whilst teaching you the finer art of this fascinating subject. The text within THE GRAPHOLOGIST was researched and written by a top London graphologist/criminologist James Woodward. The software was written by Martin Evans our consultant software writer.

@ £49.95 inc P&P + VAT

## CASHMASTER

Master your own finances. There is now no need to be frightened by accountancy software. CASHMASTER provides you with the easiest method yet invented to keep track of all your finances. Be you a business or professional individual, you are sure to need to know where your money is going. CASHMASTER will allow you to input all the necessary information per transaction in one simple operation, whilst allowing you to extract the absolute maximum from it all again with an array of statements and reports.

- Features VAT analysis
- Easy, natural data entry - Just like a handwritten ledger
- Any amount of ledger files
- Ledgers can span any time period, there is no one year limit
- Reports can be produced over any time span (1 day to 100 years)
- 90/99 Class Codes (User definable) per ledger file
- 30/99 Accounts per ledger file
- Detailed statements showing balances (Selected accounts & classes)
- Profit & Loss Statements (Selected accounts & class totals)
- Tagging of entries for extra report selectivity
- Items can be Inclusive, Exclusive or Zero VAT or VAT can be just ignored
- VAT element automatically calculated and displayed
- Pop up running total calculator
- Entries can be repeated with just one key press (Standing Orders etc) Weekly, Fortnightly, Monthly, Quarterly, Half Yearly or Yearly
- Entries can be edited or deleted at any time
- Insert entries anywhere, CASHMASTER puts them in chronological order for you.
- Reports directable to Screen, Printer or Disk file
- Detailed selectivity for reports
- Reference field for each entry (Invoice No, Desp Note No etc)
- 10,000 entries PC version, 2,900 PCW's
- No need for sorts, always in correct order
- All functions and operations available from main program screen
- Most functions operate from a single key press
- Scan through the ledger a line, or page at a time if required
- Split and merge file
- Class and Account code descriptions visible at all times. Scroll through pages of codes with one key press
- FREE separate running total calculator for adding up those cheques, useful for those quick sums.

WE APOLOGISE TO ALL OTHER SOFTWARE WRITERS AND TO ANYONE ELSE WHO HAS BOUGHT THE OTHER SO CALLED 'EASY TO USE' PROGRAMS. CASHMASTER REALLY DOES BLOW THE LID OFF COMPUTERISED ACCOUNTING.

THIS IS HOW IT SHOULD BE DONE

Not only superior to the competition, it's far cheaper too!  
@ £29.95 inc P&P + VAT

**INTRASET LTD, (DEPT AA)**  
FREEPOST  
No 10 WOODSIDE AVENUE,  
CLAYTON-LE-WOODS,  
CHORLEY, LANCASHIRE PR6 7QF  
Tel: 0490 3284 9am - 6pm or  
02572 76800 24hr ordering  
ORDER BY FAX 02572 74753

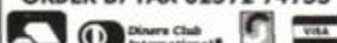



## NIGHTBREED

1

Ocean  
The arcade conversion based on the grisly film, in turn based on the book Cabal. Prove to the world you're not a psychotic killer!

## CRUISER

2

Powerplay  
The games reviewer's favourite joystick. Pick the winner and "shoot-em up" every time. "You can even hit people with it too!" Trenton W.

## IRON MAN

3

Virgin  
Ivan 'Ironman' Stewart's Super Off-Road Racer. A Super Sprint style racer for up to three players. Collect icons, upgrade your truck and burn some rubber!

## PUZZNIC

4

Ocean  
A complex puzzle game that has you matching colours and moving blocks in a multi-level brain-teaser to keep you hooked for ages.

Description	Price	Order No
Nightbreed Cass	£8.99	AA627AC
Nightbreed Disk	£11.99	AA627AD

Description	Price	Order No
Cruiser Joystick	£9.99	AA618

Description	Price	Order No
Iron Man Cass	£7.99	AA624AC
Iron Man Disk	£10.99	AA624AD

Description	Price	Order No
Puzznic Cass	£8.99	AA628AC
Puzznic Disk	£11.99	AA628AD

# AMSTRAD ACTION

THE LATEST AND GREATEST PRODUCTS AT THE BEST POSSIBLE PRICES!



HOW TO ORDER...  
JUST MAKE A NOTE OF THE PRODUCT NAME AND ORDER NUMBER AND FILL IN THE ORDER FORM OPPOSITE... OR RING OUR HOTLINE NUMBER ON 0458 74011

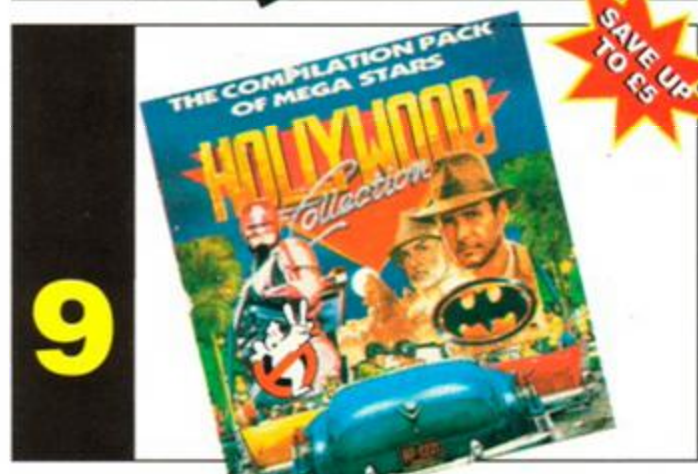

HOTLINE  
0458 74011



PRICES INCLUDE POSTAGE, PACKING AND VAT  
NO HIDDEN EXTRAS

SEE OUR AMAZING SUBSCRIPTION OFFER OF FREE SOFTWARE ON PAGE 80/81

## TOTAL RECALL

8

Ocean  
Play the part of construction worker Doug Quaid as he learns of his secret past and travels to the planet Mars

## HOLLYWOOD COLLECTION

9

Ocean  
Robocop, Ghostbusters II, Indiana Jones and Batman - all in one fabulous compilation!

## AA T-SHIRT

10

Are you one of the many loyal CPC owners who avidly reads Amstrad Action? If Yes, then spread the word by wearing this superb American T-Shirt.

## AA BINDER

11

Keep your valued Amstrad Action magazine collection together in this bright red binder.

Description	Price	Order No
T. Recall Cass	£8.99	AA630AC
T. Recall Disk	£11.99	AA630AD

Description	Price	Order No
H. Collec Cass	£11.99	AA631AC
H. Collec Disk	£14.99	AA631AD

Description	Price	Order No
Med T-Shirt	£4.99	AA361R
XL T-Shirt	£4.99	AA362R

Description	Price	Order No
One Binder	£5.99	AA417R
Two Binders	£9.00	AA4172R



## TURTLES

**5** Mirrorsoft  
Playing the part of the 'heroes in a half-shell', rescue April O'Neil from the evil Shredder and his army of Ninjitsu Warriors.

Description	Price	Order No
Turtles Cass	£10.99	AA629AC
Turtles Disk	£11.99	AA629AD

## TURRICAN

**6** Rainbow Arts  
Take *Turrican* into battle in this full-blooded shoot-out game. A massive game to keep you going for a very long time.

Description	Price	Order No
Turrican Cass	£7.99	AA622AC
Turrican Disk	£10.99	AA622AD

## STOP PRESS & MOUSE

**7** Database Software  
If you're serious about DTP then consider no other. Powerful features and a superb mouse make it excellent value for money.

Description	Price	Order No
S/P & Mouse	£64.95	AA606

HOW TO ORDER  
JUST MAKE A  
THE PRODUCT  
AND ORDER N  
AND FILL IN T  
ORDER FORM  
OPPOSITE... C  
OUR HOTLINE  
ON 0458 7401

# MAIL ORDER

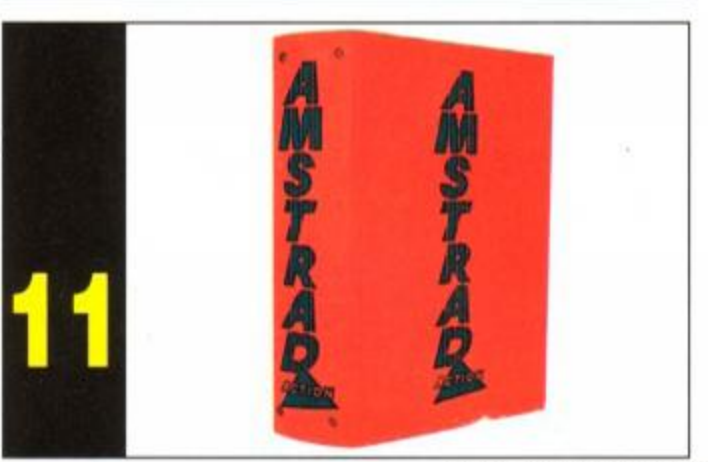
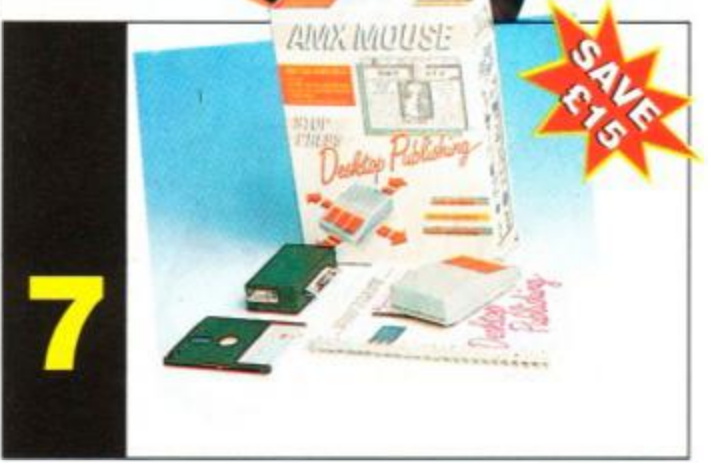
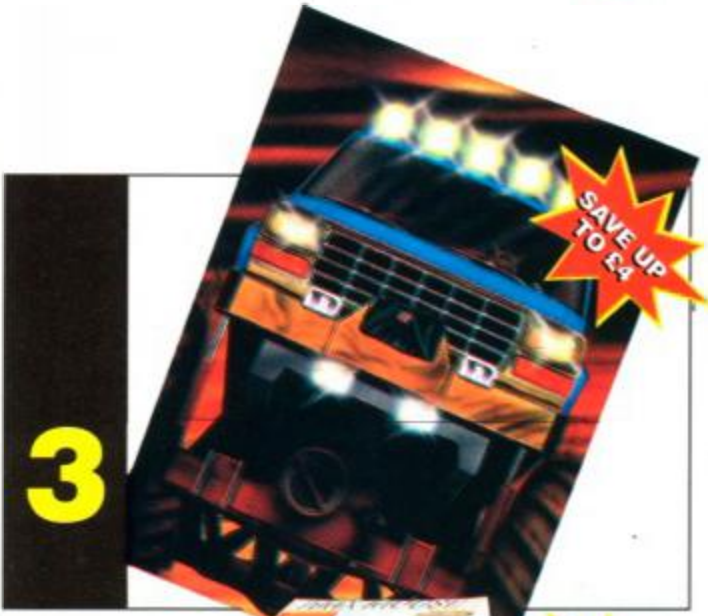

## BACK ISSUES

Want to complete your collection of the ultimate CPC magazine? Buy the following issues, for the same price as newsstand, we pay the postage!

### BUY ANY FIVE FOR

ISSUE	PRICE
ISSUE 46	£1.45
ISSUE 47	£1.45
ISSUE 51	£1.45
ISSUE 53	£1.45
ISSUE 54	£1.45
ISSUE 55	£1.45
ISSUE 56	£1.45
ISSUE 57	£1.45
ISSUE 58	£1.45
ISSUE 59	£1.45
ISSUE 60	£1.45
ISSUE 61	£1.95
ISSUE 62	£1.60

## FUN SCHOOL 3

**12** Database Software  
Bumper packages of educational software for infant and primary school children. The complete suite of six programs.  
**Teddy Bear Under 5's Frog 5-7 years / Robot Over 7**

Description	Price	Order No
T. Bear Cass	£9.99	AA632AC
T. Bear5 Disk	£11.99	AA632AD
Frog Cass	£9.99	AA633AC
Frog Disk	£11.99	AA633AD
Robot Cass	£9.99	AA634AC
Robot Disk	£11.99	AA634AD

## AMSTRAD ACTION MAIL ORDER

Name	Description	Price	Order No
Address			
Postcode			
Phone number			
Method of payment (please circle) Access • Visa • Cheque • PO		TOTAL ORDER	
Credit Card No			
Expiry date			

For overseas orders call Clare for prices on 0458 74011

SEND THIS FORM TO: Clare Bates, Amstrad Action, The Old Barn, Freepost, Somerton, Somerset, TA11

Please make all cheques payable to Future Publishing Limited

No stamp required if posted in the UK, Channel Islands or the Isle of Man



# AMSTRAD



# CAR

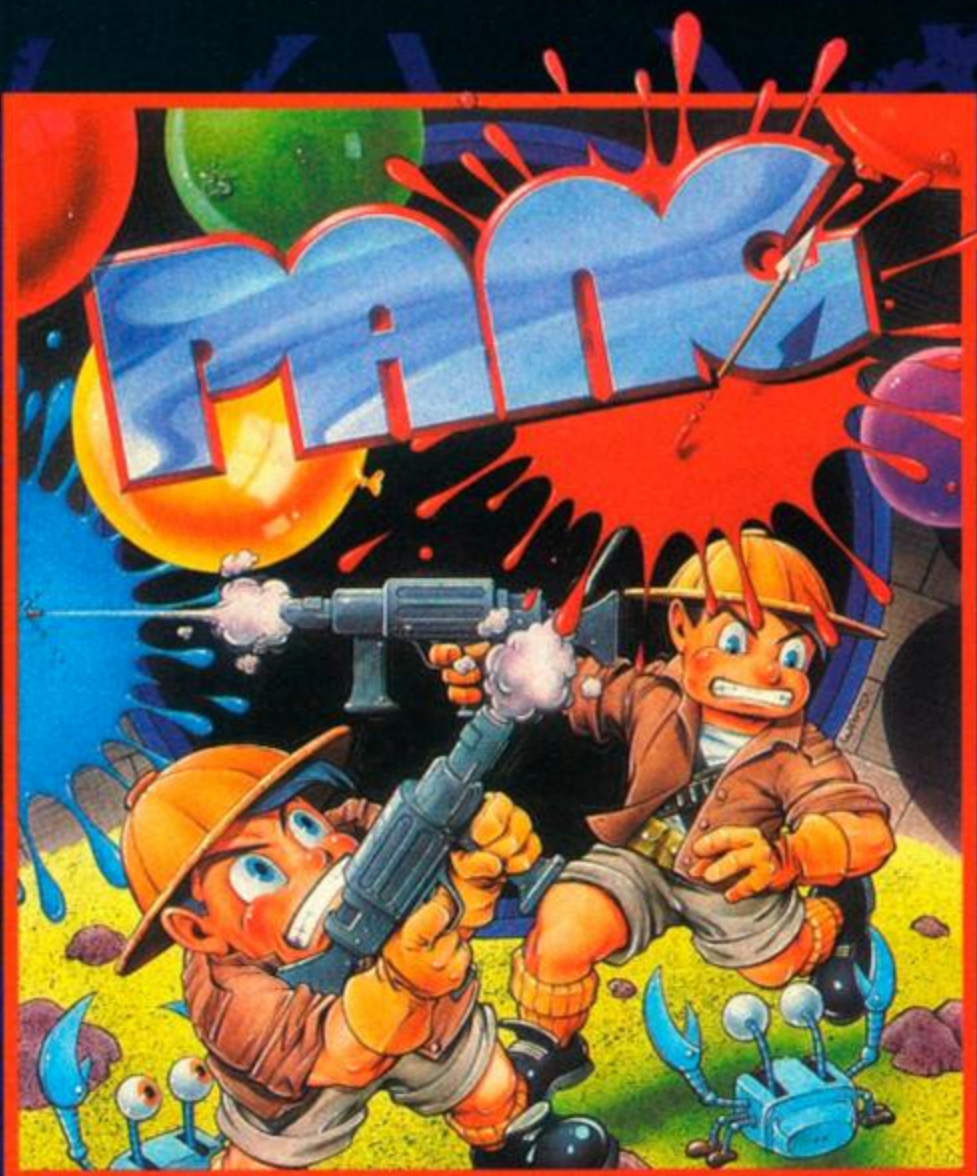

## IT'S ADDICTIVE

A per



conversion from the popular arcade game. Conquer the Balloon Invasion in this exhilarating test of your game-playing skills.

## INSTANT LOADING

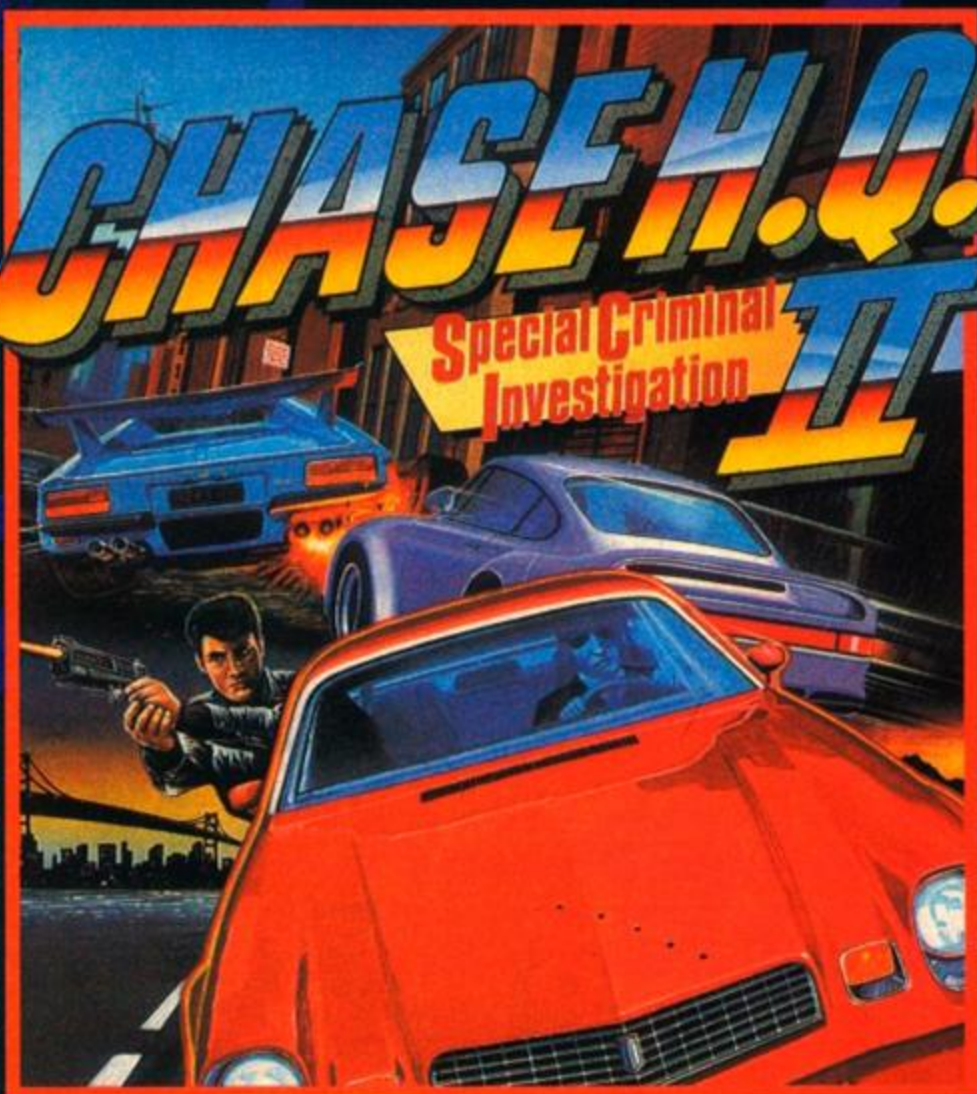

## SIMPLY PLUG STRAIGHT 464 PLUS - 612

## IT'S FAST

The meanest pursuit game



to hit your screen!  
IT'S FAST - featuring explosive turbo-boost.  
IT'S TOUGH - shoot the villains but dodge their flames.

### FROM ALL GOOD SOFTWARE STOCKISTS

OCEAN SOFTWARE LTD  
6 CENTRAL STREET  
MANCHESTER M2 5NS  
TEL: 061 832 6633  
FAX: 061 834 0650





# RIDGE

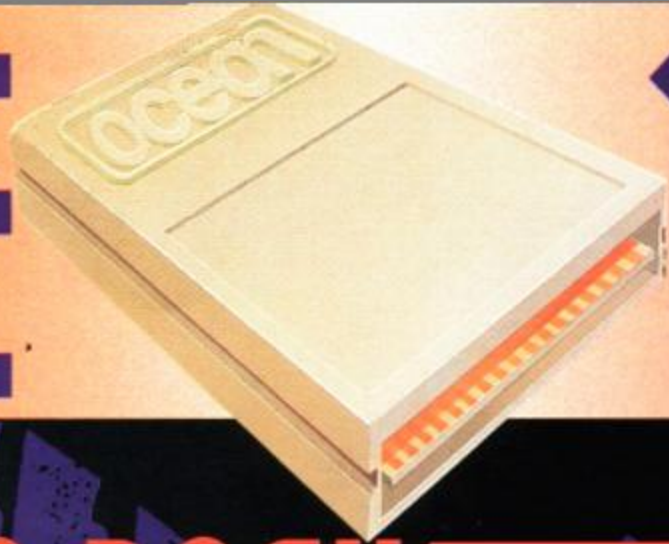

# POWER

## HE'S BACK

Murphy's back!  
Battle your way

through seven levels of  
explosive action to face  
Robocop's greatest enemy -  
Robocop 2!

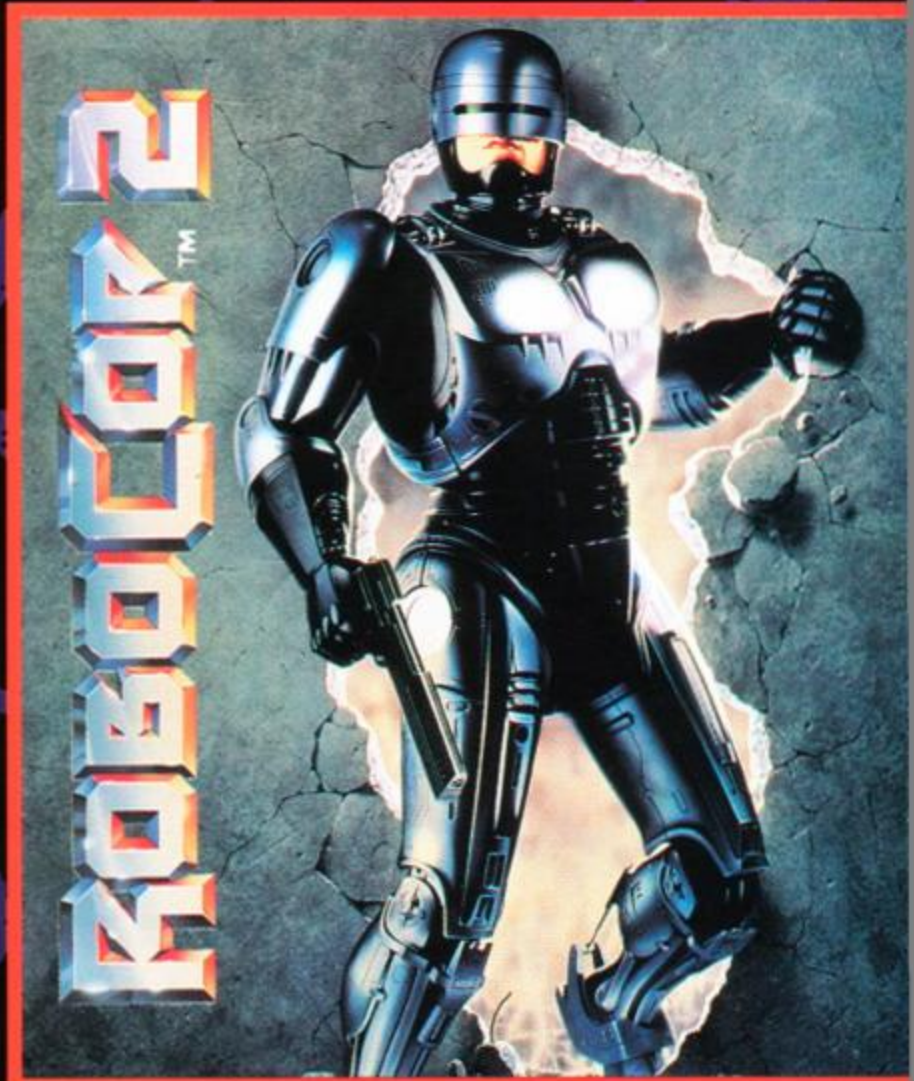

# ENHANCED GAME-PLAY FIT INTO ANY AMSTRAD PLUS - GX4000

## IT'S TOUGH

Sea, Air, Land.  
They are the  
men of the U.S. Navy's  
special forces. You control  
the team. You control the  
action. You hold the fate of  
innocent lives in your hands.

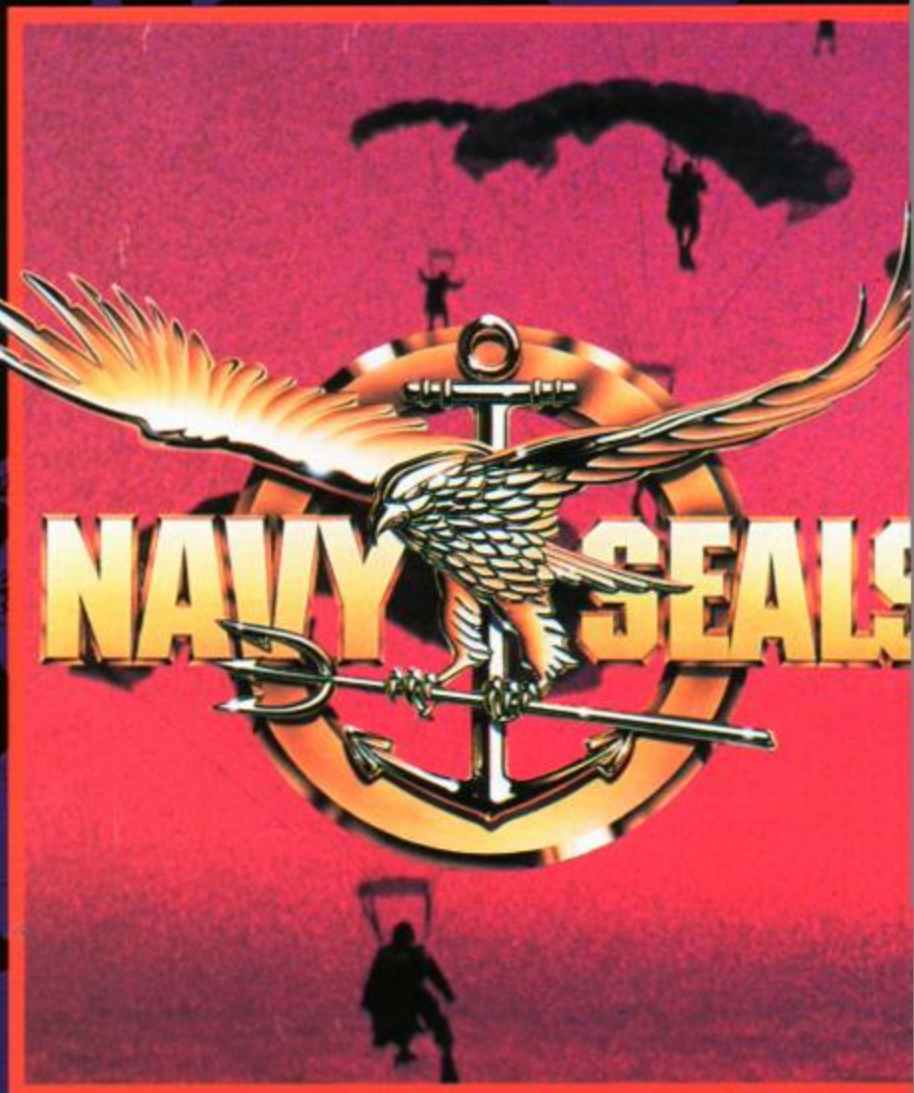

WHAT GIVES THESE FANTASTIC  
GAMES THEIR EXCLUSIVE ACTION  
AND DEPTH OF PLAY? THE SECRET IS  
THE CARTRIDGE



# PANG

OUT NOW  
FOR SPECTRI  
AMSTRAD  
COMMODO  
ATARI ST A/

THE WORLDS BEST BUBBLE BURSTER

# INVASION



**PANG —  
WHAT  
THE  
PRESS  
SAY.  
THE  
ONE**

**90%**  
"Simplicity is the spice of life - and Pang is a spicy product."  
"a refreshing blast from your arcade past" "Good, clean fun for all the family."

**AMIGA FORMAT - 87%**

"the game is incredibly difficult to put down"  
"Simple and enjoyable games like Pang don't come along too often."  
"the sheer addictiveness will keep you coming back for just a quick couple of hours 'gaming'"

**CU - "CU SCREEN STAR" - 87%**

"Superbly converted with plenty of bounce."  
"Pang plays BRILLIANTLY"  
"Ocean have managed to capture the feel of the Arcade game perfectly - and that's what makes Pang a winner."

**ACE - 840**

"Just wait till you play it - the game positively oozes addictiveness."  
"If you hanker for the days when games were fun and simple, buy Pang, - you won't regret it!"

**ZZAP - 82%**

"A polished conversion of a playable coin-op."



## BROTHERS BATTLE AGAINST BALLOONS



Tour the world in the most addictive arcade game of the year from Mitchell Corp. A black eye and super fast reflexes will give you just a half-chance of a win... the other half will come if the bounce goes your way!

Ocean Software 6 Central St  
Manchester M2 5NS  
Tel: 061 832 6633.